

INTEGRATED REFRIGERATION  
**INSTALLATION GUIDE**

---



## Contents

- 2 Integrated Refrigeration
- 3 Opening Dimensions
- 3 Electrical
- 4 Plumbing
- 4 Preparation
- 4 Anti-Tip Bracket
- 5 Placement
- 5 Alignment
- 6 Water Line
- 6 Panels
- 7 Panel Installation
- 8 Completion

## Important Note

To ensure this product is installed and operated as safely and efficiently as possible, take note of the following types of highlighted information throughout this guide:

**IMPORTANT NOTE** highlights information that is especially important.

**CAUTION** indicates a situation where minor injury or product damage may occur if instructions are not followed.

**WARNING** states a hazard that may cause serious injury or death if precautions are not followed.

## Product Information

Important product information including the model and serial number are listed on the product rating plate. For column models, the rating plate is located inside the middle drawer near the drawer guide opposite the hinge. For tall and drawer models, the rating plate is located inside the cabinet, to the left of the upper drawer. Refer to the illustrations below.

If service is necessary, contact your authorized Sub-Zero dealer.

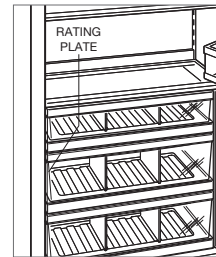

Column models

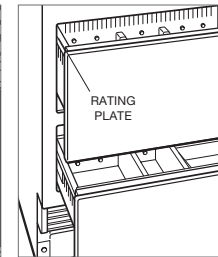

Tall and drawer models

## Tools and Materials

- Screwdrivers—standard, Phillips and Torx.
- Power drill.
- Drill bits (masonry bits required for concrete installation).
- Standard socket and wrench set.
- .6 m and 1.2 m levels.
- Tubing cutter.
- .9 m of 1/4" OD copper, braided stainless steel or PEX tubing.
- Saddle valve.
- Material to protect home, flooring and cabinetry during installation.

Opening Dimensions

INTEGRATED MODELS

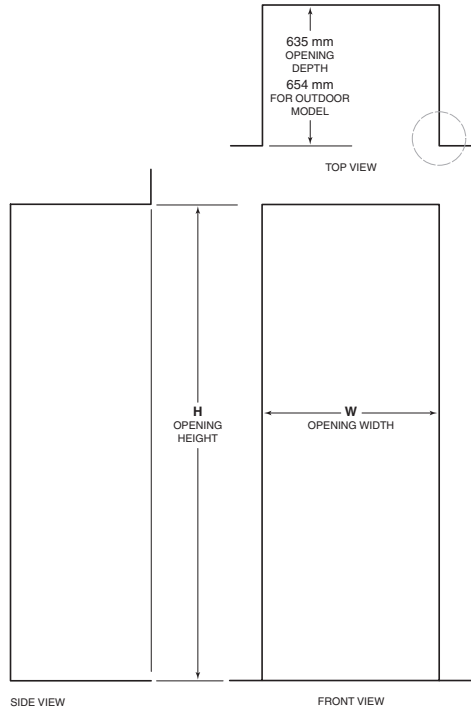

OPENING DIMENSIONS		
COLUMN AND TALL	W	H
457 mm Column	457 mm	2134 mm
610 mm Column	610 mm	2134 mm
762 mm Column and Tall	762 mm	2134 mm
914 mm Column and Tall	914 mm	2134 mm
DRAWER	W	H
610 mm Drawer	610 mm	876 mm
762 mm Drawer	762 mm	876 mm
914 mm Drawer	914 mm	876 mm

The depth of each wine storage model is 610 mm. Allow for panel thickness when planning the finished opening depth. A minimum 89 mm finished return is required on all sides of the opening—114 mm for outdoor model. Framed cabinets will require additional finished filler material behind the face frame for a proper installation. Refer to the illustration.

DUAL INSTALLATION

When installing two units side by side in a dual installation, the opening width is the width of the two units added together. A dual installation kit will be required for this installation. If a dual installation kit is not specified, a minimum 51 mm filler strip is required between units.

Dual installation kits are available through an authorized Sub-Zero dealer.

\*89 mm finished returns will be visible and should be finished to match cabinetry—114 mm for outdoor model.

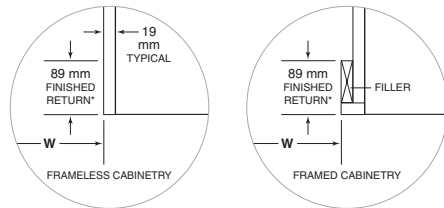

Electrical

Installation must comply with all applicable electrical codes and be properly grounded (earthed).

The electrical supply must be located within the shaded area shown in the illustration and chart below. A separate circuit, servicing only this appliance is required. Model ICBID-24RO is designed and safe for use in outdoor applications.

**IMPORTANT NOTE:** For indoor models, a ground fault circuit interrupter (GFCI) is not recommended and may cause interruption of operation.

For the outdoor model, a ground fault circuit interrupter (GFCI) is required to reduce the risk of electrical shock.

This appliance is equipped with an appliance inlet type device. The appliance inlet is located at the bottom rear of the appliance. When replacing the power cord verify the replacement cord is rated HO5VV-F3G1.0 or equivalent to ensure safe operation.

ELECTRICAL REQUIREMENTS	
Power Supply	220-240 V AC, 50/60 Hz
Circuit Breaker	10 amp
Receptacle	grounding-type (earthed)

ELECTRICAL SUPPLY LOCATION	
WIDTH	A
457 mm Models	152 mm
610 mm Models	241 mm
762 mm Models	318 mm
914 mm Models	394 mm

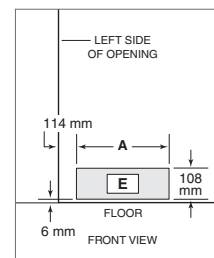

Electrical supply location

**CAUTION**

The outlet must be checked by a qualified electrician to be sure that it is wired with the correct polarity. Verify that the outlet is properly grounded (earthed).

**WARNING**

Do not use an extension cord, two-prong adapter or remove the power cord ground prong.

**Electrical Shock Hazard**

Plug power cord directly into a properly grounded (earthed) outlet. Do not defeat the grounding (earthing) nature of the plug. Do not use adapter or extension cord. Failure to follow these instructions could cause serious injury or death.

See installation instructions

Plumbing

**▲ WARNING**

Connect to potable water supply only.

Installation must comply with all applicable plumbing codes.

The water supply line should be located within the shaded area shown in the illustrations below. The water supply line should be connected to the house supply with an easily accessible shut-off valve. Do not use self-piercing valves. The water supply line must be flush to the floor and not interfere with installation of the anti-tip bracket.

An in-line filter is required for models with an ice maker or water dispenser when water conditions have a high sediment content.

A reverse osmosis system can be used provided there is constant water pressure of 2.4–8.3 bar supplied to the unit at all times. A copper line is not recommended for this application.

**PLUMBING REQUIREMENTS**

Water Supply Line	1/4" OD copper, braided stainless steel or PEX tubing
Water Pressure	2.4–8.3 bar
Excess Water Line for Connection	.9 m

**WATER SUPPLY LOCATION**

WIDTH	A
457 mm Models	76 mm
610 mm Models	140 mm
762 mm Models	152 mm
914 mm Models	229 mm

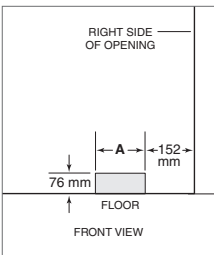

Water supply location

Preparation

**▲ WARNING**

To avoid a hazard due to instability of the appliance, it must be fixed in accordance with the instructions.

Uncrate the unit and inspect for damage. Remove the wood base and discard shipping bolts and brackets. Remove and recycle packing materials. Do not discard the kickplate, anti-tip bracket and hardware.

Remove the kickplate by extracting the two mounting screws. Refer to the illustration below.

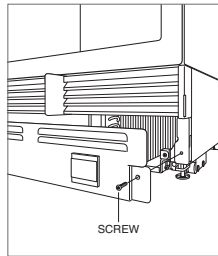

Kickplate removal

Anti-Tip Bracket

**▲ WARNING**

To prevent the unit from tipping forward, the anti-tip bracket must be installed.

The back of the anti-tip bracket must be installed 610 mm from the front of the unit (without panels).

Use all anti-tip bracket hardware as instructed for wood or concrete floors.

**IMPORTANT NOTE:** For wood or concrete floor applications, if the #12 screws do not hit a wall stud or wall plate, use the #8 screws and #12 washers with the wall anchors.

**IMPORTANT NOTE:** In some installations the subflooring or finished floor may necessitate angling the screws used to fasten the anti-tip bracket to the back wall.

**WOOD FLOOR APPLICATION**

After properly locating the anti-tip bracket in the opening, drill pilot holes 5 mm diameter maximum in the wall studs or wall plate. Use the #12 screws and washers to secure the brackets. Verify the screws penetrate through the flooring material and into wall studs or wall plate a minimum of 19 mm. Refer to the illustration and chart below.

**CONCRETE FLOOR APPLICATION**

After properly locating the anti-tip bracket in the opening, drill pilot holes 5 mm diameter maximum in the wall studs or wall plate. Drill 10 mm diameter holes into the concrete a minimum of 38 mm deep. Use the #12 screws and washers to secure the brackets to the wall, and use the 3/8" wedge anchors to secure the brackets to the floor. Verify the screws penetrate wall studs or wall plate a minimum of 19 mm. Refer to the illustration and chart below.

**ANTI-TIP BRACKET PLACEMENT**

WIDTH	A
457 mm Models	229 mm
610 mm Models	305 mm
762 mm Models	318 mm
914 mm Models	457 mm

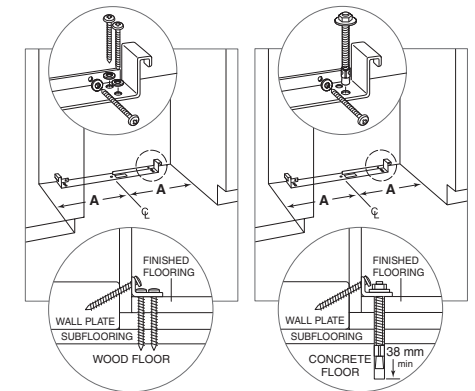

Wood floor

Concrete floor

### Anti-Tip Bracket

#### CONCRETE WEDGE ANCHOR INSTALLATION:

- 1 Drill a 10 mm diameter hole any depth exceeding the minimum embedment. Clean the hole or drill additional depth to accommodate drill fines.
- 2 Assemble the washer and nut flush with the end of anchor to protect threads. Drive the anchor through the material to be fastened until the washer is flush with the surface material.
- 3 Expand the anchor by tightening the nut 3–5 turns past hand-tight position or to 34 newton-meters of torque.

#### ⚠ WARNING

Verify there are no electrical wires or plumbing in the area which the screws could penetrate.

#### ⚠ CAUTION

Always wear safety glasses and use other necessary protective devices or apparel when installing or working with anchors.

Anchors are not recommended for use in lightweight masonry material such as block or brick, or for use in new concrete which has not had sufficient time to cure. The use of core drills is not recommended to drill holes for the anchors.

### Placement

#### ⚠ CAUTION

Before moving the unit into position, secure the door/drawers closed and protect any finished flooring.

Use an appliance dolly to move the unit near the opening. The front leveling legs are extended below the front rollers to improve stability during placement. Once the unit is placed in front of the opening, completely retract the front leveling legs to allow the unit to be rolled into position. Front and rear leveling legs can be adjusted from the front once the unit is positioned.

If the unit has been on its back or side, it must stand upright for a minimum of 24 hours before connecting power.

Plug the power cord into the grounded outlet and roll the unit into position. Verify the anti-tip bracket is properly engaged.

### Alignment

#### LEVELING

Once the unit is in position, height adjustment can be made from the front. Using a Phillips drive, turn clockwise to raise the unit or counterclockwise to lower. Use the lowest torque setting when using a power drill. Do not turn the leveling legs by hand. Refer to the illustrations below.

When the unit is properly leveled, door/drawer adjustments are less likely to be necessary.

**IMPORTANT NOTE:** Level the unit to the floor, not surrounding cabinetry. This could affect the operation of the unit, such as door closing.

#### ⚠ WARNING

To reduce the possibility of the unit tipping forward, the front leveling legs must be in contact with the floor.

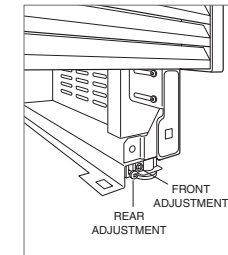

Leveling

Alignment

ANCHORING

Adjust the depth of the unit to fit flush with surrounding cabinetry. Once aligned, verify doors and drawers open properly, then install screws in each side trim.

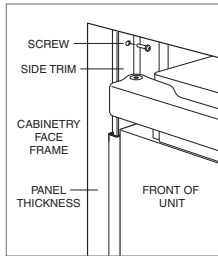

Anchoring

Water Line

Purge the water line prior to final connection to the unit. This will remove any debris that may be present in the tubing from installing the new water line. Connect the plastic tubing from the unit to the house water supply line with the fitting connection kit provided. Check all water line fittings for leaks.

Locate the water line in the notch as shown in the illustration below.

**IMPORTANT NOTE:** Water lines can not be exposed to freezing temperatures.

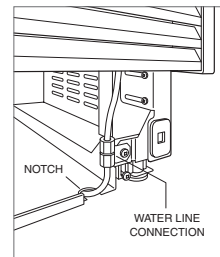

Water line.

Stainless Steel Panels

The outdoor model requires the use of Sub-Zero stainless steel outdoor accessory panels. Stainless steel panels are available through an authorized Sub-Zero dealer.

The thickness of indoor stainless steel panels is 19 mm and outdoor stainless steel panels are 38 mm. The depth of each integrated model is 610 mm. Allow for panel thickness when planning the finished opening depth.

3 mm reveals are typical, however, the reveal between the upper and lower outdoor stainless steel panels is 6 mm to accommodate the lock.

Custom Panels

For integrated models, custom door panels and handle hardware must be installed.

The thickness of the custom panel can vary. A minimum 16 mm thick panel is required, but the thickness can be increased provided it does not exceed the maximum panel weight indicated in the chart below. The depth of each integrated model is 610 mm. Allow for panel thickness when planning the finished opening depth.

PANEL REQUIREMENTS	
<b>COLUMN</b>	<b>MAX WEIGHT</b>
457 mm Models	20 kg
610 mm Models	27 kg
762 / 914 mm Models	34 kg
<b>TALL (DOOR)</b>	<b>MAX WEIGHT</b>
762 mm Models	22 kg
914 mm Models	27 kg
<b>DRAWER</b>	<b>MAX WEIGHT</b>
All Drawer Panels	7 kg
<b>PANEL THICKNESS</b>	<b>MINIMUM</b>
All Panels	16

Reveals between panels can vary, 3 mm reveals are typical.

**CAUTION**  
When installing a panel thicker than 25 mm, the 90° stop may be required to prevent damage to the unit and adjacent cabinetry.

**CAUTION**  
As reveals between cabinetry and the unit decrease, severe finger pinching can occur while door is closing.

Finish all sides of custom panels. They will be visible when the door is open.

D-style handles are recommended. Stainless steel tubular and pro handles are available through an authorized Sub-Zero dealer. Door handles must be located near the edge of the panel opposite the hinge and should be centered top to bottom. Drawer handles must be located near the top edge of each panel.

## Custom Panels

### DOOR PANEL HEIGHT

The height of the custom door panel can extend beyond the typical panel height, provided it does not exceed the weight limit. Refer to the illustration below.

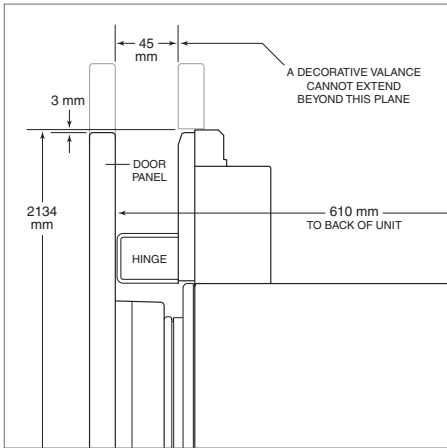

Upper valance (column and tall models)—side view

### TOE KICK CLEARANCE (EXCLUDES OUTDOOR MODEL)

The height of the toe kick area can extend beyond the typical toe kick height, provided it does not exceed the dimensions in the illustration below. Toe kick heights from 51 mm to 98 mm require a reduced toe kick accessory available through an authorized Sub-Zero dealer.

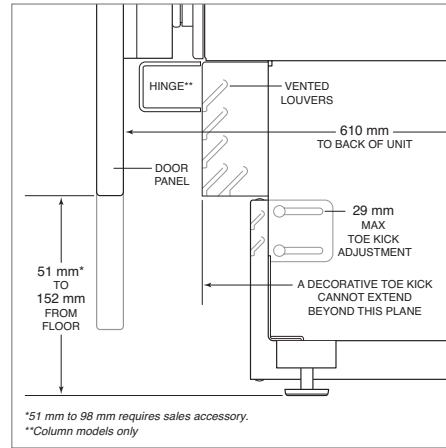

Toe kick—side view

\*51 mm to 98 mm requires sales accessory.  
\*\*Column models only

## Panel Installation

### DOOR PANEL INSTALLATION

Typical panel dimensions are based on a 2134 mm finished height with 3 mm reveals. Template placement must be adjusted for panels exceeding typical dimensions.

For tall models, the door panel should be installed first, followed by the upper then lower drawer panel.

Place the panel face down on a protected work surface. Position the template flush with the top and sides of the panel. Verify the correct side of the template is being used, then mark and drill holes. Refer to the illustration below.

For tall models, align the notch in the template with the bottom of the door panel, then mark and drill holes. Refer to the illustration below.

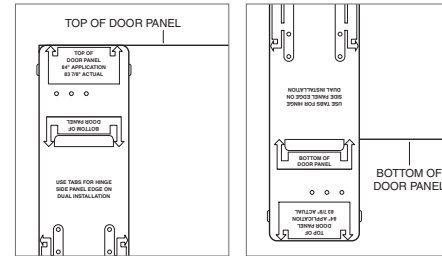

Door panel template—top

Door panel template—bottom (tall models only)

Use a Torx drive to partially insert a #8 x 13 mm screw into the second hole from the top on each side of the panel. The screws should be approximately 4 mm proud of the panel and will support the weight of the panel during installation.

Align the support screws on the back of the panel with the slotted holes on both door mounting brackets. Opening the door slightly may help with alignment. Once the panel is supported by the screws, partially insert a #8 x 13 mm screw into the second hole from the bottom on each side of the panel, but do not tighten.

### CAUTION

As the reveal between cabinets and the unit decreases, the potential exists for severe finger pinching if fingers are placed in the opening when the door is closing.

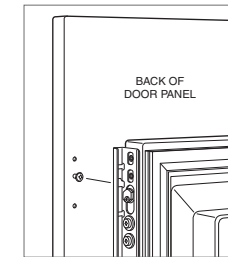

Door panel mounting

## Panel Installation

### DRAWER PANEL INSTALLATION

Place the panel face down on a protected work surface. Position the template flush with the top and sides of the panel. Verify the correct side of the template is being used, then mark and drill holes. Refer to the illustration below.

Use a Torx drive to partially insert a #8 x 13 mm screw into the second hole from the top on each side of the panel. The screws should be approximately 4 mm proud of the panel and will support the weight of the panel during installation.

Align the support screws on the back of the panel with the slotted holes on both drawer mounting brackets. Refer to the illustration below. Opening the drawer slightly may help with alignment. Once the panel is supported by the screws, partially insert a #8 x 13 mm screw into the second hole from the bottom on each side of the panel, but do not tighten.

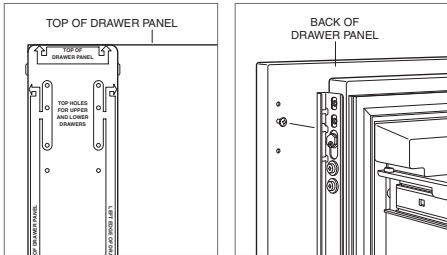

Drawer panel template—top

Drawer panel mounting

### PANEL ADJUSTMENT

Close the door and/or drawers, now adjustments can be made to align panels and reveals.

For side-to-side adjustment, move panels side to side, then install and tighten all mounting screws.

For up-and-down and in-and-out adjustments, slightly loosen the bracket screws. Depending on the level of adjustment required, it may be helpful to loosen all of the bracket screws which will allow for maximum adjustment. Once the bracket screws are loosened, use a wrench to rotate the cams to make adjustments. After adjustments have been made, tighten all bracket screws. Refer to the illustrations below.

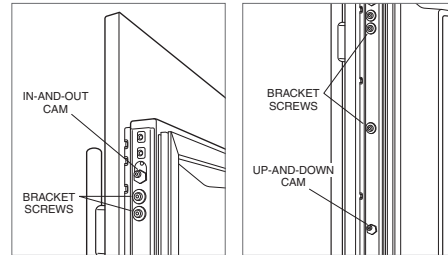

In-and-out adjustment

Up-and-down adjustment

## Completion

### DOOR TRIM INSTALLATION

After panels have been adjusted, install the decorative side trim to the door/drawers. To install, start at the top and align the trim with the front and rear flanges on the bracket, then snap into place by pushing the trim toward the back of the panel. Once the top is secure, continue the installation downward until the remaining trim is completely secure. Refer to the illustrations below.

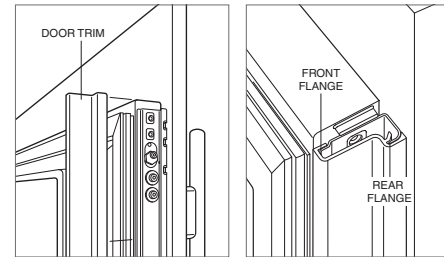

Door trim

Bracket flanges

### SIDE TRIM INSTALLATION

Install the decorative trim strip to the handle side of tall and column models. The side trim snaps over the bracket attached to the handle side of the unit. Refer to the illustration below.

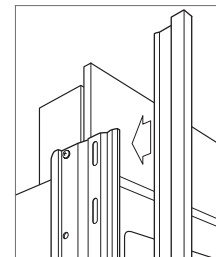

Side trim

### TOP TRIM INSTALLATION

Identify the top trim strips by the notch on one end at the bottom; this trim strip fits on the hinge side of the unit.

Insert the outer end of each trim strip behind the vertical side trim. Engage the snap in the plastic side bracket and slide the panel as far to the outside as possible. Refer to the illustration below.

Rotate the inner end of each panel into the side flange of the center shroud, next to the water filter access door. Press on the trim strip to snap into place. Refer to the illustration below.

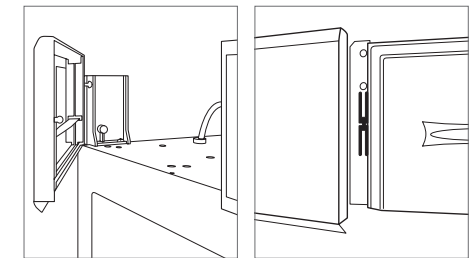

Inner top trim

Outer top trim



## Completion

### KICKPLATE INSTALLATION

Position the kickplate and install using the two mounting screws. Refer to the illustration below. Kickplate must be removable for service. The floor cannot interfere with removal.

For indoor models, a maximum 152 mm decorative kickplate can be attached to the factory-installed kickplate. The two rows of vented louvers can be covered if the door panel is a minimum 102 mm from finished floor. A decorative kickplate can not be attached to the outdoor model.

To install a decorative kickplate, remove paper backing from the magnets and attach decorative kickplate to magnets. Magnets may also be tacked into position to increase adhesion. Magnets will allow decorative kickplate to be removed, if necessary.

Turn power on by touching 'power' on the control panel.

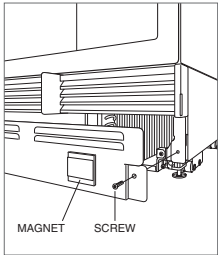

Kickplate installation

### 90° DOOR STOP

A 105° door stop is built into the hinges of tall and column units. To limit the door to 90°, open the door slightly less than 90°, then use a standard screwdriver blade to remove the existing clips from each hinge. Locate the 90° clips from inside the plastic bag containing product literature, then insert the 90° clips onto each hinge. Refer to the illustration below.

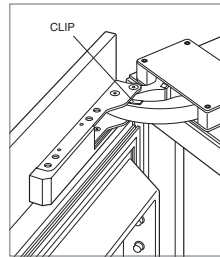

90° door stop





SUB-ZERO, INC. P.O. BOX 44848 MADISON, WI 53744 SUBZERO.COM 800.222.7820

9012951 REV-A

11/2017

