

Milwaukee®

Nothing but **HEAVY DUTY.**™



2026/27

TO DEVELOP AND PRODUCE **NOTHING BUT HEAVY DUTY™ POWER TOOLS** IS ONLY ONE PART OF THE **MILWAUKEE® PROMISE.**

These tools need to last day in and day out. For this reason, serviceability is incorporated into every tool produced.

All power tools leave the factory with a complete documentation package including instructions for use, listing of customer service centres and safety instructions. MILWAUKEE® has a worldwide service network.

Should a problem arise requiring assistance or support at short notice, you can rely on our service centres/agents worldwide.

The global network ensures that our customers' needs and requirements are shared to influence future product development.

Expertise and competence gained over many years ensures a fast and efficient professional repair service.



MILWAUKEE® strive to meet and surpass all international and European standards and directives for both design and safety. Constant research and development programs aim to anticipate and fulfil future market trends in all regulatory and efficiency requirements. MILWAUKEE® is, amongst others, an active member of EPTA (European Power Tool Association) and so is proudly aligned to all industry measurement standards agreed by the organisation.

ALWAYS BUY FROM*



BENEFIT FROM

EXTENDED GUARANTEE
OUTSTANDING SERVICE
PROFESSIONAL ADVICE

LOOK OUT FOR THE LOGO
TO ALSO QUALIFY FOR EXTENDED GUARANTEE



**PROFESSIONAL REPAIR.
COMPLETE TRACKING.**



* From 1st February 2024 the extended guarantee for eligible MILWAUKEE® power tool(s), outdoor power equipment and REDLITHIUM™ batteries will only be granted if the product is new and purchased via an Authorised MILWAUKEE® Distributor. Rights already established before 1st February 2024 shall remain unaffected.

NOTHING BUT HEAVY DUTY GUARANTEE:



*From 1st of February 2024 the extended guarantee for eligible MILWAUKEE® power tool(s), outdoor power equipment and REDLITHIUM™ batteries will only be granted if the product is new and purchased via an Authorised MILWAUKEE® Distributor. The same applies to the guarantee for MILWAUKEE® hand tool(s) as well. Rights already established before 1st of February 2024 shall remain unaffected.



For full terms and conditions for each of the above mentioned guarantees, please see the link below;
<https://www.milwaukeetool.eu/service/>

MILWAUKEE® power tool(s), outdoor power equipment & batteries come with a standard 1 year guarantee. Guarantee extensions are available by visiting www.milwaukeetool.eu.



MILWAUKEE® power tool(s) and outdoor power equipment guarantee can be extended from 1 year to a maximum of 3 years (1+2). With the exception of MX FUEL™ tools for which the guarantee can be extended from 1 year to a maximum of 2 years (1+1).

All MILWAUKEE® REDLITHIUM™ batteries including MX FUEL™ batteries come with a standard 1 year guarantee which can be extended to a maximum of 2 years (1+1).

All guarantee extensions are subject to registering online within 30 days of the purchase date.

Every MILWAUKEE® is tested according to a comprehensive certified

process before leaving the factory and is guaranteed to be **NOTHING BUT HEAVY DUTY™** qualified. At MILWAUKEE® we take great pride in the products and services we offer to our professional customers.

The guarantee extension is only available in those countries listed on our warranty registration website. The extended guarantee offer excludes products used in the hire industry, battery chargers and accessories supplied.

MILWAUKEE® hand tool lifetime guarantee
Certain MILWAUKEE® hand tools come with a lifetime guarantee which means they can be replaced or repaired free of charge should they break during normal usage due to material or manufacturing fault.*

MILWAUKEE® Levels - 30 year accuracy guarantee
The following MILWAUKEE® levels are sold with a 30 year accuracy guarantee: MILWAUKEE® BACKBONE™; Compact box levels; and the Block Torpedo level.*

MILWAUKEE® Levels - 10 year accuracy guarantee
The following MILWAUKEE® levels are sold with a 10 year accuracy guarantee: MILWAUKEE® Slim box level; REDCAST™ level; Minibox level; Billet Torpedo; and I-Beam level.*

*For full terms and conditions for each of the above mentioned guarantees, please see the link below;
<https://www.milwaukeetool.eu/service/>

CONCRETE VIBRATORS



SCAN HERE FOR MORE INFORMATION AND/ OR SEE PAGE 78 FOR RELATED SYSTEM ATTACHMENTS



See index page 130

	MXF CVHF	MXF CVBP	MXF CVBC	M18 FCVN
Platform	MX FUEL™	MX FUEL™	MX FUEL™	M18 FUEL™
ONE-KEY™	ONE-KEY™	ONE-KEY™	ONE-KEY™	-
Vibrations (1/min)	11,200	11,200	11,200	12,500
Weight with battery pack (EPTA) (kg)	10.4 (MXF XC608)	15.7 (MXF XC406)	10.3 (MXF XC406)	5.0 (M18 HB5.5)
Available versions				
-0	✓	✓	✓	✓
-551	✗	✗	✗	✓
-602	✗	✓	✓	✗
-802	✓	✗	✗	✗

COMPACTORS



SCAN HERE FOR MORE INFORMATION AND/ OR SEE PAGE 79 FOR RELATED SYSTEM ATTACHMENTS



See index page 130

	MXF PC50	MXF RAM60
Platform	MX FUEL™	MX FUEL™
ONE-KEY™	ONE-KEY™	ONE-KEY™
Centrifugal force (kN)	16	17
Travel speed (m/min)	26	20
Plate length (mm)	558	345
Plate width (mm)	508	280
Speed settings	2	2
Stroke rate (spm)	-	680
Oscillation rate (opm)	5,500	-
Tool height with handle folded (mm)	584	-
Travel direction	Reversible	One-Way
Vibration level (m/s ²)	4.3	7.2
Weight with battery pack (EPTA) (kg)	79 (MXF HD812)	77.9 (MXF HD812)
Available versions		
-0	✓	✓
-122	✓	✓

SCREED, TROWELS



SCAN HERE FOR MORE INFORMATION AND/ OR SEE PAGE 79 FOR RELATED SYSTEM ATTACHMENTS



See index page 151

	MXF PSC	MXF WBT60	MXF WBT90
Platform	MX FUEL™	MX FUEL™	MX FUEL™
Feature	-	AUTOSTOP™	AUTOSTOP™
ONE-KEY™	ONE-KEY™	ONE-KEY™	ONE-KEY™
Diameter (mm)	-	610	914
Motor speed (rpm)	-	1,600 - 3,600	1,600 - 3,600
No load speed (rpm)	-	70 - 160	60 - 130
Vibrations (1/min)	9,000	-	-
Variable speed	Yes	-	-
Vibration level (m/s ²)	5.7	1.42	0.37
Weight with battery pack (EPTA) (kg)	16.8 (MXF CP203)	62 (MXF HD812)	80 (MXF HD812)
Available versions			
-0	✓	✓	✓
-302	✓	✗	✗
-122	✗	✓	✓

CUT-OFF SAWS



SCAN HERE FOR MORE INFORMATION



See index page 131

	MXF COS350G2	M18 FCOS230
Platform	MX FUEL™	M18 FUEL™
Feature	RAPIDSTOP™	RAPIDSTOP™
ONE-KEY™	ONE-KEY™	ONE-KEY™
M18™ SWITCH TANK™ compatible	Yes	Yes
Fits MILWAUKEE cut-off saw carts	MXF COSCG2	-
Blade diameter (mm)	350	230
Bore size (mm)	20 / 25.4	22.2
Max. cutting depth (mm)	125	85
Max. water supply inlet (bar/PSI)	4/ 58	6/ 90
No load speed (rpm)	5,370	6,600
Vibration cutting (m/s ²)	3.04	1.81
Weight with battery pack (EPTA) (kg)	13.4 (MXF XC608)	6.2 (M18 HB12)
Available versions		
-0	✓	✓
-802	✗	✓
-121	✓	✗

M18 FUEL™
DRIVEN TO OUTPERFORM.™

LIMITS REDEFINED.

MORE COMPACT. UNRIVALED ACCURACY. REDEFINED PERFORMANCE.

M18 FUEL™, packs a mighty punch in a smaller package. More compact, yet more powerful, the range is perfect for those hard to reach areas, and ideal for working at height, due to the reduced size and weight, better balance and easier handling.

Put M18 FUEL™ to the test, and reset your expectations of 18 V tools.



1 POWERSTATE™ BRUSHLESS MOTOR



2 REDLINK PLUS™ INTELLIGENCE



3 REDLITHIUM™ BATTERY PACKS



M12 FUEL™
DRIVEN TO OUTPERFORM.™

M12 FUEL™ is engineered for the most demanding tradesmen in the world. M12 FUEL™ delivers extreme performance in a compact structure and features three MILWAUKEE® exclusive innovations - the POWERSTATE™ brushless motor, REDLITHIUM™ battery pack and REDLINK PLUS™ intelligence hardware and software - that deliver incredible power, run time and durability.

Simply put, M12 FUEL™ offers the best, full circle technology that drives, protects and powers your cordless tools.



MORE CAPABLE. LIGHTWEIGHT. MORE COMPACT.

THE EASIEST WAY TO KEEP TRACK OF YOUR INVENTORY



ONE-KEY™
UNLOCKING THE DIGITAL JOBSITE.™

Bluetooth LOCATION

TRACK. MANAGE. CUSTOMISE.



With ONE-KEY™ you can add tools and equipment no matter the brand to your inventory and get a full overview of ALL your assets. Add unlimited users for free, assign tools to different employees and see which tools that are currently in use, ready for use or perhaps at the service centre.

Follow a digital trace of when, where and how your tools have been used to optimise efficiency and usage, or use it to track and lock your tools and equipment if it's missing.

Print professional reports and get documentation on the tool status and usage.

All of this and much more **FOR FREE!**



GET STARTED IN 2 MINUTES

STEP 1 DOWNLOAD THE MILWAUKEE® ONE-KEY™ APP FOR FREE



STEP 2 REGISTER YOUR PROFILE FAST & EASY



STEP 3 DONE! YOU ARE NOW READY TO USE ONE-KEY™



*The Bluetooth® word mark and logos are registered trademarks owned by Bluetooth SIG, Inc., and any use of such marks by (TTI corporate name) is under license. Other trademarks and trade names are those of their respective owners.

WATER PUMPS

See index page 154



SCAN HERE FOR MORE INFORMATION



	MXF SMP2	M18 BLSWP	M12 BSWP	M18 BTP
Platform	MX FUEL™	M18™	M12™	M18™
Technology	-	Brushless	-	-
Feature	-	HYDROPASS™	HYDROPASS™	-
ONE-KEY™	ONE-KEY™	-	-	-
Run dry auto shut-off	Yes	Yes	Yes	Yes
Type of water that can be pumped	Grey water	Black water	Black water	White water
Flow rate (l/min)	320	94.5	34	30.3
Max. head height (m)	18	5.1	4.5	23
Speed (spm)	2,000 - 3,500	-	-	-
Speed settings	3	1	1	1
Thread size (mm)	50	32 female thread	19 male thread	19 male thread
Thread size (inch)	2	1 1/4" female thread	3/4" male thread	3/4" male thread
Weight with battery pack (EPTA) (kg)	23.4 (MXF XC608)	6.6 (M18 FB8)	2.0 (M12 B6)	4.1 (M18 B5)
Available versions				
-0	✓	✓	✓	✓
-601	✗	✗	✓	✗
-801	✗	✓	✗	✗
-802	✓	✗	✗	✗

CORDLESS K-HEX BREAKERS AND SDS-MAX HAMMERS

See index pages 135 - 136



SCAN HERE FOR MORE INFORMATION



	MXF DH2528H	M18 FHAC0745	M18 FHAC0540
Platform	MX FUEL™	M18 FUEL™	M18 FUEL™
Feature	-	AUTOSTOP™	AUTOSTOP™
ONE-KEY™	ONE-KEY™	ONE-KEY™	ONE-KEY™
Tool reception	28 mm K-Hex	SDS-Max	SDS-Max
Blow energy (EPTA)(J)	64	15.2	8.1
Full load hammer action (bpm)	1,300	2,625	3,300
Vibration drilling into concrete [m/s ²]	-	10.7	10.2
Vibration chiseling (m/s ²)	5.17	9.0	7.7
Weight with battery pack (EPTA) (kg)	29.6 (MXF XC406)	9.7 (M18 FB12)	7.9 (M18 FB12)
Available versions			
-0	✓	✗	✗
-0C	✗	✓	✓
-802	✓	✗	✗
-122C	✗	✓	✓

CORDED K-HEX BREAKERS AND SDS-MAX HAMMERS

See index pages 135 - 136



SCAN HERE FOR MORE INFORMATION



	K 2628 H	K 1530 H	K 1528 H	K 1000 S	K 950 S	K 900 K	K 900 S	HAC0850	K 750 S	K 545 S	K 540 S	K 500 S	PCE 3/K
Platform	Corded	Corded	Corded	Corded	Corded	Corded	Corded	Corded	Corded	Corded	Corded	Corded	Corded
Tool reception	28 mm K-Hex	30 mm K-Hex	28 mm K-Hex	SDS-Max	SDS-Max	K-Hex	SDS-Max	SDS-Max	SDS-Max	SDS-Max	SDS-Max	SDS-Max	SDS-Plus
Blow energy (EPTA)(J)	64	39	39	26	20	20	20	11.0	11.9	8.5	7.5	8.5	3.6
Power input (W)	2,400	2,100	2,100	1,750	1,700	1,600	1,600	1,470	1,550	1,300	1,100	1,300	720
Full load hammer action (bpm)	1,200	1,560	1,560	1,400 - 1,950	975 - 1,950	975 - 1,950	975 - 1,950	1,600 - 2,900	2,740	2,840	3,000	2,840	0 - 3,650
Full load speed (soft hammer) (rpm)	-	-	-	-	125 - 250	-	-	210 - 385	240	350	430	2,200	-
No load speed (rpm)	-	-	-	-	125 - 250	-	-	300	300	450	450	-	-
Max. drilling concrete/core bit/tunnel drill bit (mm)	-	-	-	-	50/ 150/ 80	-	-	-/ 150/ 65	50/ 150/ 80	45/ 100/ 65	40/ 105/ 65	-	-
Vibration drilling (m/s ²)	-	-	-	-	12.5	-	-	-	9.5	13	17.4	-	-
Vibration chiseling (m/s ²)	6.2	8.4	8.8	6.7	11	11	11	11	9.1	9	12.8	11.5	11
Weight (kg)	25.7	16.8	17.2	12.7	11.8	11.0	11.0	9.7	8.2	6.7	6.3	6.3	3.7

CORDLESS SDS-PLUS HAMMERS

See index pages 135 - 136



SCAN HERE FOR MORE INFORMATION



	M18 ONEFHPX	M18 ONEFHP	M18 ONEFHX	M18 ONEFH	M18 FHX	M18 FH		M18 FHAF0H16	M18 FHAC16	M18 BLHX	M18 BLH	M18 FHAC0D32	M18 BLHACD26	M12 FHAC16
Platform	M18 FUEL™	M18 FUEL™	M18 FUEL™	M18 FUEL™	M18 FUEL™	M18 FUEL™		M18 FUEL™	M18 FUEL™	M18™	M18™	M18 FUEL™	M18™	M12 FUEL™
Technology	-	-	-	-	-	-		-	-	Brushless	Brushless	-	Brushless	-
Feature	AUTOSTOP™	AUTOSTOP™	AUTOSTOP™	AUTOSTOP™	AUTOSTOP™	AUTOSTOP™		AUTOSTOP™	AUTOSTOP™	-	-	AUTOSTOP™	-	-
ONE-KEY™	ONE-KEY™	ONE-KEY™	ONE-KEY™	ONE-KEY™	-	-		ONE-KEY™	-	-	-	ONE-KEY™	-	-
FIXTEC™ chuck	Yes	No	Yes	No	Yes	No		No	No	Yes	No	No	No	No
Blow energy (EPTA)(J)	5.0	5.0	2.5	2.5	2.5	2.5		2.3	1.7	2.3	2.3	4.9	2.6	1.15
Max. percussion rate (bpm)	4,600	4,600	4,800	4,800	4,800	4,800		4,740	5,080	4,900	5,100	4,600	4,600	4,410
Max. drilling wood/ steel/ concrete (mm)	30/ 13/ 32	30/ 13/ 32	28/ 13/ 26	28/ 13/ 26	28/ 13/ 26	28/ 13/ 26		// 16	// 16	26/ 13/ 26	26/ 13/ 26	30/ 13/ 32	28/ 13/ 26	- / - / 16
Vibration drilling into concrete [m/s ²]	8.4	8.4	15.9	15.9	15.9	15.9		12.5	13.6	14.9	14.9	10.5	13.9	12.3
Vibration chiseling (m/s ²)	7.9	7.9	14.2	14.2	14.2	14.2		-	10.9	12.7	12.7	9.4	13.2	10.3
Weight with battery pack (EPTA) (kg)	5.2 (M18 HB5.5)	5.0 (M18 HB5.5)	4.5 (M18 HB5.5)	4.3 (M18 HB5.5)	4.4 (M18 HB5.5)	4.3 (M18 HB5.5)		3.3 (M18 HB3)	2.6 (M18 HB3)	3.5 (M18 B5)	3.3 (M18 B5)	5.9 (M18 HB5.5)	3.1 (M18 B4)	2.3 (M12 HB5)
Fits MILWAUKEE™ dust extractors	M18 FPDDEXL	M18 FPDDEXL	M18 FCDDEXL/ M18 FDDEXL	M18 FCDDEXL/ M18 FDDEXL	M18 FCDDEXL/ M18 FDDEXL	M18 FCDDEXL/ M18 FDDEXL		Integrated dust extractor	M18 FDDEC	M18 CDEX	M18 CDEX	M18 FDDEL32	M18 CDEX	-
Available versions														
-0	✓	✗	✓	✓	✓	✓		✓	✓	✗	✓	✓	✓	✓
-0X	✓	✓	✓	✓	✓	✓		✓	✓	✓	✗	✗	✓	✓
-0C	✗	✗	✗	✗	✗	✗		✗	✗	✗	✗	✓	✗	✗
-302X	✗	✗	✗	✗	✗	✗		✓	✓	✗	✗	✗	✗	✗
-402X	✗	✗	✗	✗	✗	✗		✗	✗	✗	✗	✗	✓	✗
-502X	✗	✗	✗	✗	✗	✗		✗	✗	✓	✓	✗	✗	✓
-552X	✓	✗	✓	✗	✓	✗		✗	✗	✗	✗	✗	✗	✗

CORDED SDS-PLUS HAMMERS

See index pages 135 - 136



SCAN HERE FOR MORE INFORMATION



	PLH 32 XE	PLH 28 XE	PLH 28 E	PH 30 POWER X		PH 28 X	PH 28	PH 26 TX	PH 26 T	PFH 26 T
Platform	Corded	Corded	Corded	Corded		Corded	Corded	Corded	Corded	Corded
Tool reception	SDS-Plus + Reduced shank 13 mm	SDS-Plus + Reduced shank 13 mm	SDS-Plus	SDS-Plus + Reduced shank 13 mm		SDS-Plus + Reduced shank 13 mm	SDS-Plus	SDS-Plus	SDS-Plus	SDS-Plus
FIXTEC™	Yes	Yes	No	Yes		Yes	No	Yes	No	No
Blow energy (EPTA)(J)	3.8	4.1	4.1	3.6		3.4	3.4	2.4	2.4	2.4
Power input (W)	900	800	800	1,030		820	820	800	800	800
Full load hammer action (bpm)	0 - 4,500	0 - 4,000	0 - 4,000	0 - 3,800		0 - 4,000	0 - 4,000	0 - 4,500	0 - 4,500	0 - 4,500
Full load speed (rpm)	0 - 800	0 - 1,000	0 - 1,000	0 - 850		0 - 900	0 - 900	0 - 1,500	0 - 1,500	0 - 1,500
Max. drilling wood/ steel/ concrete (mm)	40/ 16/ 32	40/ 13/ 28	40/ 13/ 28	40/ 13/ 30		30/ 13/ 28	30/ 13/ 28	30/ 13/ 26	30/ 13/ 26	30/ 13/ 26
Vibration drilling (m/s ²)	22	10.6	10.6	22		22	22	12	13.6	13.6
Vibration chiseling (m/s ²)	20	6.81	6.81	14		16	16	10.8	11.9	11.9
Weight (kg)	3.6	3.6	3.4	2.9		2.9	2.7	2.6	2.4	2.4

HAMMER AND DUST EXTRACTOR SETS

See index page 135



SCAN HERE FOR MORE INFORMATION



	M18 ONEFHPXDEL	M18 ONEFHXDEL	M18 FHACDDE
Platform	M18 FUEL™	M18 FUEL™	M18 FUEL™
Hammer	M18 ONEFHPX - M18 FUEL™ high performance 4-mode 32 mm SDS-Plus hammer with ONE-KEY™ and FIXTEC™ chuck	M18 ONEFHX - M18 FUEL™ 4-mode 26 mm SDS-Plus hammer with FIXTEC™ chuck and ONE-KEY™	M18 FHAC16 - M18 FUEL™ high performance 4-mode 16 mm SDS-Plus hammer
Dust extraction	M18 FPDDEXL - Dedicated dust extraction for M18 FUEL™ 32 mm SDS-Plus hammers with AUTOPULSE™	M18 FDDEXL - Dedicated dust extraction for M18 FUEL™ 26 mm SDS-Plus hammers with AUTOPULSE™	M18 FDDEC - M18™ dedicated dust extractor for M18 FUEL™ high performance 4-mode 16 mm SDS-Plus hammer
Available versions			
-0C	✗	✗	✓
-552C	✓	✓	✗

DIAMOND DRILLS

See index page 131



SCAN HERE FOR MORE INFORMATION AND/OR SEE PAGES 82 - 83 FOR RELATED SYSTEM ATTACHMENTS



	MXF DCD350	MXF DCD150	DD 2-160 XE	DD 3-152
Platform	MX FUEL™	MX FUEL™	Corded	Corded
Feature	-	AUTOSTOP™	-	-
ONE-KEY™	ONE-KEY™	ONE-KEY™	-	-
Drilling capacity in concrete 1st/ 2nd/ 3rd/ 4th gear (mm)	152 - 356/ 76 - 152/ 51 - 76/ 13 - 51	76 - 152/ 25 - 76	80 - 162/ 32 - 90	62 - 152/ 32 - 62/ 12 - 32
Max. drilling concrete (mm)	350	150	150	152
No load speed (rpm)	0 - 390/ 0 - 850/ 0 - 1,650/ 0 - 2,200	0 - 800/ 0 - 1,600	0 - 1,500/ 0 - 3,000	0 - 1,000/ 0 - 2,100/ 0 - 3,900
Tool reception	1 1/4" UNC	1 1/4" UNC + 1/2" G	M18 x 2.5	1/2" G + 1 1/4" UNC
Mounting	Stand mount	Stand mount/ handheld	Handheld	Stand mount/ handheld
Weight (kg)	54 (MXF HD812)	12.4 (MXF CP203)	4.2	6.5
Available versions				
-0	✓	✗	✗	✗
-0C	✗	✓	✗	✗
-302C	✗	✓	✗	✗
-122	✓	✗	✗	✗

DEDICATED DUST EXTRACTORS

See index page 131



SCAN HERE FOR MORE INFORMATION AND/OR SEE PAGE 113 FOR RELATED SYSTEM ATTACHMENTS



	M18 FPDDEXL	M18 FDDEL32	M18 FDDEXL	M18 FCDDEXL	M18 FDDEC	M18 CDEX	M12 UDEL
Platform	M18™	M18™	M18™	M18™	M18™	M18™	M12™
Feature	AUTOPULSE™	AUTOPULSE™	AUTOPULSE™	AUTOPULSE™	-	-	-
Max. drill bit diameter (mm)	32	32	26	26	16	16	30
Max. drill bit length (mm)	260	260	210	200	165	160	210
Max. drilling depth (mm)	230	203	152	96	75	90	203
Stroke length (mm)	203	203	152	96	75	100	203
Weight (kg)	2.0	1.9	1.9	1.4	0.9	1.6	2.0
Available versions							
-0	✓	✓	✓	✓	✓	✓	✗
-0B	✗	✗	✗	✗	✗	✗	✓
-201B	✗	✗	✗	✗	✗	✗	✓

CARTS, TROLLEYS, STANDS

See index page 129



SCAN HERE FOR MORE INFORMATION



	MXF COSCG2	MXF DR255TV	MXF DHT	BRT
Max. drilling core bit (mm)	-	250	-	-
Stroke length (mm)	-	570	-	-
Tank capacity (l)	15	-	-	-
Weight (kg)	37.2	13.2	15.7	14.3
Fits MILWAUKEE diamond drills	-	MXF DCD150	-	-
Fits MILWAUKEE breakers	-	-	MXF DH2528H	K 2628 H
Fits MILWAUKEE cut-off saws	MXF COS350G2	-	-	-

CHAIN HOIST

See index page 129



SCAN HERE FOR MORE INFORMATION



	M18 BLCHTO
Platform	M18™
Technology	Brushless
Feature	AUTOSTOP™
ONE-KEY™	ONE-KEY™
Chain size (mm)	6.35 x 19.05
Lifting speed (m/min)	2.4
Loading capacity (kg)	1000
Max. lift (m)	18.3
Weight with battery pack (EPTA) (kg)	23.5 (M18 HB12)
Available versions	
-121	✓

CONSTRUCTION TOOLS - GRINDERS WITH DUST MANAGEMENT, WALL CHASERS, IMPACT WRENCHES, PADDLE MIXER



SCAN HERE FOR MORE INFORMATION



See index pages 130 - 131

	AGV 12 DEC	AGV 12 DEG	AGV 15 DEC	AGV 15 DEG		WCE 30	WCS 45	IPWE 400 R	IPWE 520 R	M18 FPM
Platform	Corded	Corded	Corded	Corded		Corded	Corded	Corded	Corded	M18 FUEL™
Power input (W)	1,200	1,200	1,550	1,550		1,500	1,900	725	725	-
No load speed (rpm)	11,000	11,000	11,000	11,000		9500	5800	0 - 1,700	0 - 1,700	0 - 550
Cutting width (mm)	-	-	-	-		26	45	-	-	-
Max. cutting depth (mm)	28	28	28	28		30	45	-	-	-
Disc diameter (mm)	125	125	125	125		125	150	-	-	-
Impact rate (ipm)	-	-	-	-		-	-	1,000 - 2,600	1,000 - 2,500	-
Fastening torque (Nm)	-	-	-	-		-	-	400	520	-
Tool reception	-	-	-	-		-	-	1/2" square	3/4" square	M14
Max. recommended mixing capacities (l)	-	-	-	-		-	-	-	-	20
Max. stirrer paddle diameter (mm)	-	-	-	-		-	-	-	-	120
Weight (kg)	2.4	2.4	2.6	2.6		4.3	6.6	2.7	2.8	3.0 (M18 B5)

PERCUSSION DRILLS



SCAN HERE FOR MORE INFORMATION



See index pages 143 - 144

	M18 ONEPD3	M18 FPD3	M18 BLPD2		M18 BLPDRC	M12 FPD2	M12 FPD3	M12 BLPDRC
Platform	M18 FUEL™	M18 FUEL™	M18™		M18™	M12 FUEL™	M12 FUEL™	M12™
Technology	-	-	Brushless		Compact Brushless	-	-	Compact Brushless
Feature	AUTOSTOP™	AUTOSTOP™	-		-	-	-	-
ONE-KEY™	ONE-KEY™	-	-		-	-	-	-
Max. drilling wood/ steel/ masonry (mm)	89/ 16/ 16	89/ 16/ 16	76/ 13/ 16		52/ 13/ 16	35/ 13/ 13	35/ 13/ 13	32/ 10/ 10
Max. percussion rate (bpm)	0 - 33,000	0 - 33,000	0 - 28,800		25,500	0 - 22,500	0 - 25,500	0 - 23,250
Max. torque (Nm)	158	158	82		60.5	45	44	40
No load speed (rpm)	0 - 500/ 0 - 2,100	0 - 500/ 0 - 2,100	0 - 550/ 0 - 1,800		0 - 550/ 0 - 1,700	0 - 450/ 0 - 1,550	0 - 450/ 0 - 1,700	0 - 450/ 0 - 1,550
Chuck capacity (mm)	13	13	13		13	13	13	10
Speed settings	2	2	2		2	2	2	2
Weight with battery pack (EPTA) (kg)	2.2 (M18 B5)	2.2 (M18 B5)	2.1 (M18 B5)		1.5 (M18 B5)	1.4 (M12 B6)	1.2 (M12 B2)	0.93 (M12 B2)
Available versions								
-0	✓	✓	✗		✓	✓	✓	✓
-0X	✓	✓	✓		✓	✗	✗	✗
-202C	✗	✗	✗		✓	✗	✗	✓
-202X	✗	✗	✗		✗	✓	✓	✗
-402C	✗	✓	✗		✓	✗	✗	✓
-402X	✗	✗	✓		✗	✓	✗	✗
-502C	✗	✗	✗		✓	✗	✗	✗
-502X	✓	✓	✓		✗	✗	✗	✗
-602X	✗	✗	✗		✗	✓	✗	✗

DRILL DRIVERS



SCAN HERE FOR MORE INFORMATION



See index page 132

	M18 ONEDD3	M18 FDD3	M18 BLDD2		M18 BLDDRC	M12 FDD2	M12 BLDDRC	M12 FDDX	M12 BDDX
Platform	M18 FUEL™	M18 FUEL™	M18™		M18™	M12 FUEL™	M12™	M12 FUEL™	M12™
Technology	-	-	Brushless		Compact Brushless	-	Compact Brushless	-	-
Feature	AUTOSTOP™	AUTOSTOP™	-		-	-	-	-	-
ONE-KEY™	ONE-KEY™	-	-		-	-	-	-	-
Chuck capacity (mm)	13	13	13		13	13	10	10	10
Max. drilling wood/ steel (mm)	89/ 16	89/ 16	76/ 13		52/ 13	35/ 13	40/ 10	28/ 10	25/ 10
Max. torque (Nm)	158	158	82		61	45	40	34	32
No load speed (rpm)	0 - 500/ 0 - 2,100	0 - 500/ 0 - 2,100	0 - 550/ 0 - 1,800		0 - 550/ 0 - 1,700	0 - 450/ 0 - 1,550	0 - 450/ 0 - 1,550	0 - 400/ 0 - 1,600	0 - 400/ 0 - 1,500
Weight with battery pack (EPTA) (kg)	2.1 (M18 B5)	2.1 (M18 B5)	2.0 (M18 B5)		1.5 (M18 B5)	1.4 (M12 B6)	0.98 (M12 B2)	0.90 (M12 B2)	1.2 (M12 B2)
Available versions									
-0	x	✓	x		✓	✓	✓	✓	x
-0X	✓	✓	✓		✓	x	x	✓	x
-202C	x	x	x		✓	x	✓	x	✓
-202X	x	x	x		x	✓	x	✓	x
-402C	x	✓	x		✓	x	✓	x	x
-402X	x	x	✓		x	✓	x	x	x
-502C	x	x	x		✓	x	x	x	x
-502X	✓	✓	✓		x	x	x	x	x
-602X	x	x	x		x	✓	x	x	x

ROTARY DRILLS AND DRIVERS



SCAN HERE FOR MORE INFORMATION



See index page 150

	PD2E 24 R	PD2E 22 R	PD-705	PDE 13 RX	DE 13 RP	DE 10 RX
Platform	Corded	Corded	Corded	Corded	Corded	Corded
Power input (W)	1,020	850	705	630	630	630
Chuck capacity (mm)	13	13	13	13	13	10
No load speed (rpm)	0 - 1,000/ 0 - 3,200	0 - 1,000/ 0 - 3,200	0 - 3,000	0 - 2,900	0 - 950	0 - 2,700
Max. drilling wood/ steel/ masonry/ concrete (mm)	40/ 16/ 24/ 22	40/ 13/ 22/ 20	30/ 13/ 16/ 15	30/ 13/ 18/ 15	40/ 13/ /	30/ 10/ / -
Max. static stalling torque (Nm)	60	56	15	21	59	21
Weight (kg)	3.0	2.9	1.9	1.8	2.1	1.6

DRILL PRESS



SCAN HERE FOR MORE INFORMATION



See index page 133

	M18 FMDP	MDE 41	MDP 41
Platform	M18 FUEL™	Corded	Corded
Feature	AUTOSTOP™	AUTOSTOP™	AUTOSTOP™
Magn. holding power (at drill point pressure) (N)	8,890	9,930	8,890
Max. depth broaching capacity (mm)	50	50	50
Max. diameter broaching capacity (mm)	38	41	41
Max. drilling solid bit (mm)	13	13	13
No load speed (rpm)	400 / 690	475 / 730	475 / 730
Stroke length (mm)	146	-	-
Weight (kg)	13.0 (M18 B5)	13.5	14.0
Available versions			
-0C	✓	x	x
-502C	✓	x	x

IMPACT DRIVERS



SCAN HERE FOR MORE INFORMATION



See index pages 137 - 138

	M18 ONEID3	M18 FID3	M18 FIDRQ	M18 BLIDR	M12 FID2	M12 BLIDRC	M18 BRAID	M12 BRAID	M12 FQID
Platform	M18 FUEL™	M18 FUEL™	M18 FUEL™	M18™	M12 FUEL™	M12™	M18™	M12™	M12 FUEL™
Technology	-	-	SURGE™	Brushless	-	Compact Brushless	-	-	SURGE™
ONE-KEY™	ONE-KEY™	-	-	-	-	-	-	-	-
Impact rate (ipm)	1,400/ 3,600/ 4,400/ 0 - 4,400	1,400/ 3,600/ 4,400/ 0 - 4,400	6,300	2,500/ 4,700/ 4,900	1,300/ 3,500/ 4,000/ 0 - 4,000	0 - 4,100	2,400/ 3,400	0 - 3,300	950/ 2,200/ 3,400/ 0 - 3,400
Max. torque (Nm)	226	226	113	190	170	124	41/ 81	68	50
No load speed (rpm)	1,750/ 3,000/ 4,000/ 0 - 4,000	1,750/ 3,000/ 3,900/ 0 - 3,900	1,200/ 2,100/ 3,200	1,250/ 2,400/ 3,600	1,700/ 2,900/ 3,600/ 0 - 3,600	3,000	1,500/ 2,250	0 - 2,425	1,100/ 2,200/ 3,200/ 3,200
Tool reception	¼" Hex	¼" Hex	¼" Hex	¼" Hex	¼" Hex	¼" Hex	¼" Hex	¼" Hex	¼" Hex
Weight with battery pack (EPTA) (kg)	1.7 (M18 B5)	1.7 (M18 B5)	1.8	1.3 (M18 B5)	1.1 (M12 B6)	0.78 (M12 B2)	1.8 (M18 B5)	1.2 (M12 B2)	1.1 (M12 B2)
Available versions									
-0	✓	✓	✓	✓	✓	✓	✓	✓	✓
-0X	✓	✓	✓	✓	✓	✓	✓	✓	✓
-202C	✓	✓	✓	✓	✓	✓	✓	✓	✓
-202X	✓	✓	✓	✓	✓	✓	✓	✓	✓
-502X	✓	✓	✓	✓	✓	✓	✓	✓	✓

RIVET GUNS



SCAN HERE FOR MORE INFORMATION AND/ OR SEE PAGE 95 FOR RELATED SYSTEM ATTACHMENTS



See index page 150

	M18 ONEFLT	M18 ONEFPRT	M12 BPRT
Platform	M18 FUEL™	M18 FUEL™	M12™
ONE-KEY™	ONE-KEY™	ONE-KEY™	-
Max. pulling force (N)	20,000	20,000	9,000
Lockbolt diameter range (mm)	4.8 and 6.4 (Hucktainer® : 9.53 mm)	-	-
Lockbolt fastener type	Bobtail®;C120L®;C6L®;Hucktainer®;-Magna-Grip®	-	-
Max. rivets popped with M18 B2 battery (mm)	-	900 x 4.8 / 500 x 6.4	-
Max. rivets popped with M12 B2 battery (mm)	-	-	325 x 4.8
Rivet diameter range (mm)	-	4.8 - 7.0	2.4 - 4.8
Stroke length (mm)	30	30	20.32
Tips supplied (mm)	-	4.8, 6.0, 6.4, 7.0	2.4, 3.2, 4.0, 4.8
Weight with battery pack (EPTA) (kg)	2.8 (M18 B5)	2.5 (M18 B2)	2.1 (M12 B2)
Available versions			
-0	✓	✓	✓
-0X	✓	✓	✓
-201X	✓	✓	✓
-202X	✓	✓	✓
-502X	✓	✓	✓

SCREWDRIVERS



SCAN HERE FOR MORE INFORMATION AND/ OR SEE PAGE 95 FOR RELATED SYSTEM ATTACHMENTS



See index pages 151 - 152

	M18 FSG	M12 CD	M12 BD	M12 BSD
Platform	M18 FUEL™	M12 FUEL™	M12™	M12™
Max. drilling wood/ steel (mm)	-	25/ 10	22/ 10	16/ 10
Max. torque (Nm)	13	37	30	20
No load speed (rpm)	0 - 4,500	0 - 450/ 0 - 1,700	0 - 400/ 0 - 1,500	0 - 500
Tool reception	¼" Hex	¼" Hex	¼" Hex	¼" Hex
Weight with battery pack (EPTA) (kg)	2.0 (M18 B2)	1.2 (M12 B2)	1.0 (M12 B2)	0.90 (M12 B2)
Available versions				
-0	✓	✓	✓	✓
-0X	✓	✓	✓	✓
-202C	✓	✓	✓	✓
-202X	✓	✓	✓	✓

RIGHT ANGLE DRILLS



SCAN HERE FOR MORE INFORMATION



See index page 150

	M18 FRAD2	M18 CRAD2	C18 RAD	C12 RAD
Platform	M18 FUEL™	M18 FUEL™	M18™	M12™
Chuck capacity (mm)	13	13	10	10
Max. drilling wood/ steel (mm)	152/ 13	/ 12.7	28/ 10	22/ 10
Max. torque (Nm)	122	30	20	12
No load speed (rpm)	0 - 500/ 0 - 1,550	0 - 1,500	0 - 1,500	0 - 800
Weight with battery pack (EPTA) (kg)	6.4 (M18 B5)	4.1 (M18 B5)	1.9 (M18 B5)	1.1 (M12 B2)
Available versions				
-0	✓	✓	✓	✓
-0X	✓	✓	✓	✓
-202B	✓	✓	✓	✓

IMPACT WRENCHES

See index pages 138 - 139



SCAN HERE FOR MORE INFORMATION AND/ OR SEE PAGE 96 FOR RELATED SYSTEM ATTACHMENTS



	M12 FRAIWF12	M12 FRAIWF38	M18 BRAIW	M12 FSCIWF14	M12 FSCIWF38	M12 FCIWF38G3	M12 FCIWP12G3	M12 FCIWF12G3	M18 FIW2F38	M18 FIW2P12	M18 FIW2F12	M18 ONEIWF12	M18 FMTIW2F38
Platform	M12 FUEL™	M12 FUEL™	M18™	M12 FUEL™	M12 FUEL™	M12 FUEL™	M12 FUEL™	M12 FUEL™	M18 FUEL™	M18 FUEL™	M18 FUEL™	M18 FUEL™	M18 FUEL™
ONE-KEY™	-	-	-	-	-	-	-	-	-	-	-	ONE-KEY™	-
Tool reception	½" square	¾" square	¾" square	¼" square	¾" square	¾" square	½" square	½" square	¾" square	½" square	½" square	½" square	¾" square
Fastening torque (Nm)	270	270	40/ 76	41/ 68/ 95/ 9	68/ 203/ 271/ 14	271/ 406/ 542/ 20	271/ 406/ 542/ 20	271/ 406/ 542/ 20	102/ 203/ 339/ 34	102/ 203/ 339/ 34	102/ 203/ 339/ 34	40/ 120/ 220/ 300	475/ 610/ 745/ 47
Nut-busting torque (Nm)	300	300	-	136	305	745	745	745	339	339	339	300	813
Impact rate (ipm)	0-1,350/ 0-2,700/ 0-3,600	0-1,350/ 0-2,700/ 0-3,600	0 - 2,400 / 0 - 3,400	0-1,350 / 0-3,700 / 0-4,400 / 0-4,400	0-1,000 / 0-3,400 / 0-3,600 / 0-3,600	0-1,500 / 0-3,000 / 0-3,300 / -	0-1,500 / 0-3,000 / 0-3,300 / -	0-1,500 / 0-3,000 / 0-3,300 / -	0-1,000/ 0-2,400/ 0-3,500	0-1,000 / 0-2,400 / 0-3,500	0-1,000 / 0-2,400 / 0-3,400	1,300/2,100/2,550/3,200	0-900/ 0-2,100/ 0-3,100
Weight with battery pack (EPTA) (kg)	1.7 (M12 B4)	1.7 (M12 B4)	1.8 (M18 B5)	0.86 (M12 HB2.5)	0.91 (M12 HB2.5)	1.5 (M12 HB5)	1.5 (M12 HB5)	1.5 (M12 HB5)	1.8 (M18 B5)	1.8 (M18 B5)	1.8 (M18 B5)	1.8 (M18 B5)	2.3 (M18 B5)
Available versions													
-0	✓	✓	✓	✓	✓	✓	✓	✓	✗	✗	✗	✗	✗
-0X	✗	✗	✗	✗	✗	✗	✗	✗	✓	✓	✓	✓	✓
-252X	✗	✗	✗	✓	✓	✗	✗	✗	✗	✗	✗	✗	✗
-502X	✗	✗	✗	✗	✗	✓	✗	✓	✗	✓	✓	✓	✗



	M18 FMTIW2P12	M18 FMTIW2F12	M18 ONEFHIWP12	M18 ONEFHIWF12	M18 FHIW2F12	M18 FHIW2P12	M18 ONEFHIWF34	M18 ONEFHIWF1	M18 ONEFHIWF1DS	M18 ONEFHIWF1D	M18 ONEFHIWH716	M18 ONEFHIWF12E	M18 FHIWF1R
Platform	M18 FUEL™	M18 FUEL™	M18 FUEL™	M18 FUEL™	M18 FUEL™	M18 FUEL™	M18 FUEL™	M18 FUEL™	M18 FUEL™	M18 FUEL™	M18 FUEL™	M18 FUEL™	M18 FUEL™
ONE-KEY™	-	-	ONE-KEY™	ONE-KEY™	-	-	ONE-KEY™	ONE-KEY™	ONE-KEY™	ONE-KEY™	ONE-KEY™	ONE-KEY™	-
Tool reception	½" square	½" square	½" square	½" square	½" square	½" square	¾" square	1" square	1" square	1" square	7/16" Hex	½" square	1" square
Fastening torque (Nm)	475/ 610/ 745/ 47	475/ 610/ 745/ 47	190/ 400/ 1,017/ 1,017	130/ 400/ 1,356/ 1,356	881/ 1,220/ 1,491/ 68	475/ 1,017/ 1,220/ 68	702/ 1,138/ 1,627/ 1,627	530/ 1,020/ 1,800/ 2,033	1,180/ 1,254/ 1,966/ 2,576	1,180/ 1,254/ 1,966/ 2,576	1,017	102/ 203/ 610/ 1,017	730/ 1,500/ 2,000
Nut-busting torque (Nm)	881	881	1,491	1,898	2,034	1,491	2,034	2,400	2,711	2,711	1,017	1,500	2,000
Impact rate (ipm)	0-900 / 0-2,100 / 0-3,100	0-900 / 0-2,100 / 0-3,100	0-1,150/ 0-2,100/ 0-2,400/ 0-2,400	0-950/ 0-1,750/ 0-2,100/ 0-2,100	0-1,300/ 0-2,200/ 0-2,400/ 0-2,400	0-1,400/ 0-2,500/ 0-2,700/ 0-2,700	0-850/ 0-1,850/ 0-2,400/ 0-2,400	1,350/ 1,650/ 2,100/ 0-2,500	750/ 930/ 1,200/ 1,440	750/ 930/ 1,200/ 1,440	0- 800/ 0-1,300/ 0-2,600/ 0-1,600/ 0-2,400/ 0-2,400/ 1,750/ 2,150/ 2,500/ 2,500		
Weight with battery pack (EPTA) (kg)	2.3 (M18 B5)	2.3 (M18 B5)	3.2 (M18 B5)	3.3 (M18 B5)	3.4 (M18 B5)	3.4 (M18 B5)	3.5 (M18 B5)	5.9 (M18 FB8)	11.1 (M18 FB12)	12.7 (M18 FB12)	3.3 (M18 B5)	3.3 (M18 B5)	7.8 (M18 FB12)
Available versions													
-0C	✗	✗	✗	✗	✗	✗	✗	✗	✓	✓	✗	✗	✓
-0X	✓	✓	✓	✓	✓	✓	✓	✓	✗	✗	✓	✓	✗
-502X	✓	✓	✓	✓	✓	✓	✓	✗	✗	✗	✗	✗	✗
-802X	✗	✗	✗	✗	✗	✗	✗	✓	✗	✗	✗	✗	✗
-121C	✗	✗	✗	✗	✗	✗	✗	✗	✓	✓	✗	✗	✗
-122C	✗	✗	✗	✗	✗	✗	✗	✗	✗	✗	✗	✗	✓

RATCHETS

See index pages 149 - 150



SCAN HERE FOR MORE INFORMATION AND/ OR SEE PAGE 113 FOR RELATED SYSTEM ATTACHMENTS



	M12 IR	M12 FIR14G2	M12 FIR38G2	M12 FIR12G2	M12 FIR38LR	M12 FHIR14LR	M12 FHIR38LR	M12 FPTR
Platform	M12™	M12 FUEL™	M12 FUEL™	M12 FUEL™	M12 FUEL™	M12 FUEL™	M12 FUEL™	M12 FUEL™
Tool reception	3/8" square	1/4" square	3/8" square	1/2" square	3/8" square	1/4" square	3/8" square	14.4 mm Hex
Max. torque (Nm)	47	61	95	108	75	47	47	81
No load speed (rpm)	0 - 250	0 - 550	0 - 400	0 - 300	0 - 200	0 - 450	0 - 450	0 - 350
Length (mm)	274	300	303	308	363	348	363	386
Weight with battery pack (EPTA) (kg)	0.9 (M12 B2)	0.9 (M12 HB2.5)	0.9 (M12 HB2.5)	1.0 (M12 HB2.5)	1.4 (M12 B2)	1.1 (M12 B2)	1.1 (M12 B2)	1.2 (M12 B2)
Available versions								
-0	✓	✓	✓	✓	✓	✓	✓	✓
-201B	✓	✗	✗	✗	✗	✗	✗	✗
-202X	✗	✗	✗	✗	✗	✗	✗	✓
-252B	✗	✓	✓	✓	✗	✗	✗	✗

PRECISION FASTENING

See index page 148



SCAN HERE FOR MORE INFORMATION



	M18 ONEFIW2FC12	M18 ONEFMTIW2FC12	M12 ONEFTR38	M12 ONEFTR12
Platform	M18 FUEL™	M18 FUEL™	M12 FUEL™	M12 FUEL™
ONE-KEY™	ONE-KEY™	ONE-KEY™	ONE-KEY™	ONE-KEY™
Tool reception	1/2" square	1/2" square	3/8" square	1/2" square
Accuracy	-	-	CW ±2 %, CCW ±3%	CW ±2 %, CCW ±3%
Fastening torque (Nm)	67 - 203	67 - 338	135.6	203.4
Torque range (Nm)	-	-	13.6 - 135.6	16.9 - 203.4
Nut-busting torque (Nm)	298	746	-	-
Impact rate (ipm)	0 - 1,650/ 0 - 2,475/ 0 - 3,000/ 0 - 3,500	0 - 1,800/ 0 - 2,300/ 0 - 2,800/ 0 - 3,400	-	-
No load speed (rpm)	0 - 1,125/ 0 - 1,525/ 0 - 1,850/ 0 - 2,325	0 - 1,250/ 0 - 1,725/ 0 - 2,000/ 0 - 2,400	0 - 100	0 - 100
Weight with battery pack (EPTA) (kg)	2.0 (M18 B5)	2.5 (M18 B5)	2.5 (M12 B2)	2.6 (M12 B2)
Available versions				
-0X	✓	✓	✗	✗
-0C	✗	✗	✓	✓
-201C	✗	✗	✓	✓

GREASE AND CAULK GUNS

See index page 134



SCAN HERE FOR MORE INFORMATION AND/ OR SEE PAGE 110 FOR RELATED SYSTEM ATTACHMENTS



	M18 GG	M12 GG	C18 PCG/600	M12 PCG/600	C18 PCG/400	M12 PCG/400	C18 PCG/310	M12 PCG/310
Platform	M18™	M12™	M18™	M12™	M18™	M12™	M18™	M12™
Max. pushing force (N)	-	-	4,500	1,780	4,500	1,780	4,500	1,780
Pressure (bar)	690	562	-	-	-	-	-	-
Speed settings	-	-	6	6	6	6	6	6
Weight with battery pack (EPTA) (kg)	3.9 (M18 B2)	3.2 (M12 B4)	2.3 (M18 B2)	1.9 (M12 B2)	2.3 (M18 B2)	1.9 (M12 B2)	2.3 (M18 B2)	1.9 (M12 B2)
Available versions								
-0	✓	✓	✗	✓	✗	✓	✗	✓
-0B	✗	✗	✓	✗	✗	✗	✓	✗
-201B	✗	✗	✓	✓	✓	✓	✓	✓
-201C	✓	✗	✗	✗	✗	✗	✗	✗
-401B	✗	✓	✗	✗	✗	✗	✗	✗

ANGLE GRINDERS

See index pages 124 - 126



SCAN HERE FOR MORE INFORMATION AND/OR SEE PAGE 100 FOR RELATED SYSTEM ATTACHMENTS



	M18 ONEFLAG230XPDB	M18 FLAG230XPDB	M18 FHSAG0180VXPDB2	M18 FHSAG150XPDB2	M18 FHSAG150XB2		M18 FHSAG125XPDB2	M18 FHSAG125XB2	M18 FHSAGSV0125X	M18 FSAGSV0125X	M18 FHSAG0125VXPDB2	M18 ONEFSAG125XPDB
Platform	M18 FUEL™	M18 FUEL™	M18 FUEL™	M18 FUEL™	M18 FUEL™		M18 FUEL™	M18 FUEL™	M18 FUEL™	M18 FUEL™	M18 FUEL™	M18 FUEL™
Feature	RAPIDSTOP™	-	RAPIDSTOP™	RAPIDSTOP™	RAPIDSTOP™		RAPIDSTOP™	RAPIDSTOP™	RAPIDSTOP™	RAPIDSTOP™	RAPIDSTOP™	RAPIDSTOP™
ONE-KEY™	ONE-KEY™	-	ONE-KEY™	-	-		-	-	ONE-KEY™	ONE-KEY™	ONE-KEY™	ONE-KEY™
No load speed (rpm)	6,600	6,600	5,000 - 8,400	9,000	9,000		9,000	9,000	3,000 - 9,000	3,500 - 8,500	3,500 - 9,000	8,500
Disc diameter (mm)	230	230	180	150	150		125	125	125	125	125	125
Weight with battery pack (EPTA) (kg)	5.4 (M18 HB12)	5.3 (M18 HB12)	3.6 (M18 FB8)	3.5 (M18 FB8)	3.5 (M18 FB8)		3.5 (M18 FB8)	3.5 (M18 FB8)	3.7 (M18 FB8)	3.0 (M18 B5)	3.5 (M18 FB8)	2.7 (M18 B5)
Switch type	Paddle (Deadman) switch	Paddle (Deadman) switch	Paddle (Deadman) switch	Paddle (Deadman) switch	Slide lock-on switch		Paddle (Deadman) switch	Slide lock-on switch	Deadman switch	Deadman switch	Paddle (Deadman) switch	Paddle (Deadman) switch
Brake	Yes	Yes	Yes	Yes	Yes		Yes	Yes	Yes	Yes	Yes	Yes
Anti-kickback protection	Yes	Yes	Yes	Yes	Yes		Yes	Yes	Yes	Yes	Yes	Yes
FIXTEC™	Yes	Yes	Yes	Yes	Yes		Yes	Yes	Yes	Yes	Yes	Yes
Line lock out function	Yes	Yes	Yes	Yes	Yes		Yes	Yes	Yes	Yes	Yes	Yes
Available versions												
-0	✓	✗	✗	✗	✗		✗	✗	✗	✗	✗	✗
-0C	✓	✓	✗	✗	✗		✗	✗	✗	✗	✗	✗
-0X	✗	✗	✓	✓	✓		✓	✓	✓	✓	✓	✓
-502X	✗	✗	✗	✗	✗		✗	✗	✗	✓	✗	✓
-802X	✗	✗	✗	✗	✗		✓	✓	✗	✗	✓	✗
-121C	✗	✓	✗	✗	✗		✗	✗	✗	✗	✗	✗
-122C	✓	✗	✗	✗	✗		✗	✗	✗	✗	✗	✗



	M18 ONEFSAG125XB	M18 FSAG125XB	M18 FSAG125X	M18 FSAGV125XPDB	M18 FSAGV125XB		M18 FSAGF125XPDB	M18 FSAGF125XB	M18 BLSAG125X	M18 BLSAG125XPD	M18 BLSAG115XPD	M12 FCOT
Platform	M18 FUEL™	M18 FUEL™	M18 FUEL™	M18 FUEL™	M18 FUEL™		M18 FUEL™	M18 FUEL™	M18™	M18™	M18™	M12 FUEL™
Technology	-	-	-	-	-		-	-	Brushless	Brushless	Brushless	-
Feature	RAPIDSTOP™	RAPIDSTOP™	-	RAPIDSTOP™	RAPIDSTOP™		RAPIDSTOP™	RAPIDSTOP™	-	-	-	-
ONE-KEY™	ONE-KEY™	-	-	-	-		-	-	-	-	-	-
No load speed (rpm)	8,500	8,500	8,500	3,500 - 8,500	3,500 - 8,500		8,500	8,500	11,000	11,000	11,000	20,000
Disc diameter (mm)	125	125	125	125	125		125	125	125	125	115	76
Weight with battery pack (EPTA) (kg)	2.7 (M18 B5)	2.7 (M18 B5)	2.7 (M18 B5)	2.7 (M18 B5)	2.7 (M18 B5)		2.6 (M18 B5)	2.6 (M18 B5)	2.4 (M18 B4)	2.4 (M18 B4)	2.4 (M18 B4)	1.1 (M12 B2)
Switch type	Slide lock-on switch	Slide lock-on switch	Slide lock-on switch	Paddle (Deadman) switch	Slide lock-on switch		Paddle (Deadman) switch	Slide lock-on switch	Slide lock-on switch	Paddle (Deadman) switch	Paddle (Deadman) switch	Trigger lock-off switch
Brake	Yes	Yes	No	Yes	Yes		Yes	Yes	No	No	No	No
Anti-kickback protection	Yes	Yes	Yes	Yes	Yes		Yes	Yes	Yes	Yes	Yes	No
FIXTEC™	Yes	Yes	Yes	Yes	Yes		Yes	Yes	Yes	Yes	Yes	No
Line lock out function	Yes	Yes	Yes	Yes	Yes		Yes	Yes	Yes	Yes	Yes	Yes
Available versions												
-0	✗	✓	✓	✗	✓		✗	✗	✓	✓	✓	✓
-0X	✓	✓	✓	✓	✓		✓	✓	✗	✗	✗	✗
-402X	✗	✗	✗	✗	✗		✗	✗	✓	✓	✗	✗
-422X	✗	✗	✗	✗	✗		✗	✗	✗	✗	✗	✓
-502X	✗	✓	✗	✗	✗		✗	✗	✗	✗	✗	✗

CORDED ANGLE GRINDERS

See index pages 124 - 126



SCAN HERE FOR MORE INFORMATION AND/ OR SEE PAGE 100 FOR RELATED SYSTEM ATTACHMENTS



	AGVM 26	AGV 26	AGVM 24	AGVKB 24	AGVK 24		AGV 24	AG 24	AGV 22	AG 22		AGV 17				
Platform	Corded	Corded	Corded	Corded	Corded		Corded	Corded	Corded	Corded	Corded	Corded	Corded	Corded	Corded	
Power input (W)	2,600	2,600	2,400	2,400	2,400		2,400	2,400	2,200	2,200	2,200	2,200	1,750	1,750	1,750	
No load speed (rpm)	6,600	6,600	6,600	6,500	6,600		6,600	6,600	8,500	6,600	8,500	6,600	2,600 - 11,000	11,000	9,500	
Disc diameter (mm)	230	230	230	230	230		230	230	180	230	180	230	125	125	150	
Weight (kg)	5.8	5.5	5.8	5.9	5.4		5.5	5.3	5.3	5.4	5.1	5.2	2.8	2.8	3.0	
Brake	No	No	No	Yes	No		No	No	No	No	No	No	No	No	No	
Anti-kickback protection	Yes	No	Yes	Yes	Yes		No	No	No	No	No	No	Yes	Yes	Yes	
FIXTEC™	Yes	No	Yes	Yes	No		No	No	No	No	No	No	Yes	Yes	Yes	
AVS Anti-Vibration System	Yes	Yes	Yes	Yes	Yes		Yes	No	Yes	Yes	No	No	No	No	No	
AVS side handle	Yes	Yes	Yes	Yes	Yes		Yes	No	Yes	Yes	No	No	Yes	Yes	Yes	
Rotatable main handle	Yes	Yes	Yes	Yes	No		Yes	No	No	No	No	No	No	No	No	
Autobalancer system	Yes	Yes	Yes	No	No		Yes	No	No	No	No	No	No	No	No	
Line lock out function	Yes	Yes	Yes	Yes	Yes		Yes	Yes	Yes	Yes	No	No	Yes	Yes	Yes	
Available versions																
Trigger lock-on switch	✓	✓	✓	✓	✓		✓	✓	✓	✓	✗	✗	✓	✓	✗	✗
Deadman switch	✓	✓	✗	✗	✓		✗	✓	✗	✓	✓	✓	✗	✓	✓	✓



	AGV 17 INOX	AGV 15-125 XC	AGV 15-125 XE	AGV 15-150 XC	AGV 13	AGV 13 XSPDEB		AGV 13 XSPDE	AG 13 XSPD	AGV 12	AGV 10 EK	AG 10 EK	AG 800 EK	AG 800 E
Platform	Corded	Corded	Corded	Corded	Corded	Corded		Corded	Corded	Corded	Corded	Corded	Corded	Corded
Power input (W)	1,750	1,550	1,550	1,550	1,250	1,250		1,250	1,250	1,200	1,000	1,000	800	800
No load speed (rpm)	2,000 - 7,600	11,000	2,800 - 11,000	9,000	2,800 - 11,500	12,000		12,000	12,000	11,000	11,000	11,000	11,500	11,500
Disc diameter (mm)	125	125	125	150	125	125		125	125	125	125	125	125	125
Weight (kg)	2.8	2.6	2.6	2.6	2.4	2.5		2.5	2.3	2.4	2.2	2.1	2.0	2.0
Brake	No	No	No	No	No	Yes		No	No	No	No	No	No	No
Anti-kickback protection	Yes	Yes	Yes	Yes	Yes	Yes		Yes	No	Yes	No	No	No	No
FIXTEC™	Yes	Yes	Yes	Yes	Yes	Yes		Yes	Yes	Yes	No	No	No	No
AVS Anti-Vibration System	No	No	No	No	Yes	No		No	No	No	No	No	No	No
AVS side handle	Yes	Yes	Yes	Yes	Yes	Yes		Yes	No	Yes	Yes	No	No	No
Autobalancer system	No	No	No	No	No	No		No	No	No	No	No	No	No
Line lock out function	Yes	Yes	Yes	Yes	Yes	Yes		Yes	No	Yes	Yes	Yes	Yes	Yes
Available versions														
Deadman switch	✗	✗	✗	✓	✗	✓		✓	✓	✗	✗	✗	✗	✗
Trigger lock-on switch	✓	✗	✗	✗	✗	✗		✗	✗	✗	✗	✗	✗	✗
Slide lock-on switch	✓	✓	✓	✗	✓	✗		✗	✗	✓	✓	✓	✓	✓

STRAIGHT GRINDERS

See index pages 153 - 154



SCAN HERE FOR MORE INFORMATION AND/ OR SEE PAGE 92 FOR RELATED SYSTEM ATTACHMENTS



	M18 FDGROVPDB	M18 FDGROVB	M18 FDGRB	M12 FDGA2	M12 FDGS	DG 30 E	DG 7 E	DGL 30 E	DGL 34
Platform	M18 FUEL™	M18 FUEL™	M18 FUEL™	M12 FUEL™	M12 FUEL™	Corded	Corded	Corded	Corded
Feature	RAPIDSTOP™	RAPIDSTOP™	RAPIDSTOP™	-	-	-	-	-	-
ONE-KEY™	ONE-KEY™	ONE-KEY™	-	-	-	-	-	-	-
Switch type	Paddle (Deadman) switch	Slide lock-on switch	Slide lock-on switch	Trigger lock-off switch	Trigger lock-off switch	Slide lock-on switch	Slide lock-on switch	Slide lock-on switch	Slide lock-on switch
Brake	Yes	Yes	Yes	Yes	Yes	No	No	No	No
Line lock out function	Yes	Yes	Yes	Yes	Yes	No	No	No	No
Collet capacity (mm)	6 & 8	6 & 8	6 & 8	6 & 8	6 & 8	6	6 & 8	6	6
Max. cutting diameter (mm)	50	50	50	50	50	50	50	50	50
Max. grinding accessories diameter (mm)	76	76	50	76	50	40	45	40	40
Power input (W)	-	-	-	-	-	500	600	600	500
No load speed (rpm)	8,000 - 20,000	8,000 - 20,000	27,000	3,000 - 20,000	0 - 10,000/ 0 - 15,000/ 0 - 21,000	10,000 - 30,000	3,000 - 7,000	10,000 - 30,000	34,000
Variable speed	Yes	Yes	No	Yes	Yes	Yes	Yes	Yes	No
Weight (kg)	2.1 (M18 B5)	2.1 (M18 B5)	2.0 (M18 B5)	1.0 (M12 HB5)	0.94 (M12 B4)	1.3	1.5	1.9	1.8
Available versions									
-0	✗	✗	✓	✓	✓	✗	✗	✗	✗
-0X	✓	✓	✓	✗	✗	✗	✗	✗	✗
-422B	✗	✗	✗	✗	✓	✗	✗	✗	✗
-502X	✗	✓	✓	✗	✗	✗	✗	✗	✗
-522B	✗	✗	✗	✓	✗	✗	✗	✗	✗

POLISHERS

See index page 146



SCAN HERE FOR MORE INFORMATION



	M18 FAP	M18 FROP21	M18 FROP15	M12 BPS	AGS 15-125 C	AS 12 E	AP 12 E	AP 14-2 200 E
Platform	M18 FUEL™	M18 FUEL™	M18 FUEL™	M12™	Corded	Corded	Corded	Corded
Diameter of orbit (mm)	-	21	15	-	-	-	-	-
Disc diameter (mm)	180	150	125	76	125	125	150	200
No load speed (rpm)	360 - 2,200	2,400 - 4,500	2,650 - 5,100	2,800 / 8,300	7,600	1,800 - 4,800	900 - 2,500	490 - 2,100
Power input (W)	-	-	-	-	1,500	1,200	1,200	1,450
Soft start function	Yes	Yes	Yes	No	Yes	Yes	Yes	Yes
Variable speed	Yes	Yes	Yes	Yes	No	Yes	Yes	Yes
Weight (kg)	2.2 (M18 B5)	3.3 (M18 B5)	3.2 (M18 B5)	1.0 (M12 B2)	2.4	2.5	2.2	2.3
Recommended for	Cordless detailing	Polishing bigger vehicles, boats, tractors	Polishing cars	Detailed polishing	Grinding & sanding of metal	Sanding of metal	Polishing cars	Polishing cars
Available versions								
-0	✓	✗	✓	✓	✗	✗	✗	✗
-0X	✓	✓	✓	✗	✗	✗	✗	✗
-421X	✗	✗	✗	✓	✗	✗	✗	✗
-502X	✓	✓	✓	✗	✗	✗	✗	✗

METAL SAWS

See index pages 140 - 141



SCAN HERE FOR MORE INFORMATION



	M18 FMCS66	M18 FMCS	MCS 66	CHS 355
Platform	M18 FUEL™	M18 FUEL™	Corded	Corded
Blade diameter (mm)	203	150	203	355
Bore size (mm)	15.87	20	15.87	25.4
Cutting cap. L-shape profile 90° / 45° (mm)	-	-	-	130 / 80
Cutting capacity rectangle 90° / 45° (mm)	-	-	-	230 x 70 / 100 x 80
Cutting capacity round profile 90° / 45° (mm)	-	-	-	125 / 100
Cutting cap. square profile 90° / 45° (mm)	-	-	-	115 / 80
Max. cutting depth (mm)	66	57	-	66
No load speed (rpm)	4,000	3,900	4,000	3,800
Power input (W)	-	-	1,800	2,300
Weight (kg)	7.5 (M18 HB12)	2.8 (M18 B5)	6.4	18
Available versions				
-0	✗	✓	✗	✗
-0X	✗	✓	✗	✗
-0C	✓	✗	✗	✗
-422X	✗	✗	✗	✗
-502X	✗	✓	✗	✗

BAND SAWS

See index page 126



SCAN HERE FOR MORE INFORMATION AND/ OR SEE PAGE 101 FOR RELATED SYSTEM ATTACHMENTS



	M18 FBS127	M18 FBS127D0	M18 FBS85	M12 FBS64	M12 BS	BS 125
Platform	M18 FUEL™	M18 FUEL™	M18 FUEL™	M12™	M12™	Corded
ONE-KEY™	-	ONE-KEY™	-	-	-	-
Blade length (mm)	1,139.8	1,139.8	898.52	776.3	687.57	1,139.8
Cutting capacity rect. stock (mm)	127 x 127	127 x 127	85	64	41 x 41	125 x 125
No load speed (m/min)	0 - 168	0 - 168	0 - 165	0 - 174	0 - 85	0 - 116
Power input (W)	-	-	-	-	-	1,100
Weight (kg)	5.8 (M18 B5)	5.8 (M18 B5)	3.9 (M18 B2)	3.2 (M12 B4)	1.6 (M12 B2)	6.5
Available versions						
-0	✓	✗	✗	✗	✗	✗
-0C	✗	✓	✓	✗	✗	✗
-202C	✗	✗	✓	✗	✗	✗
-402C	✗	✗	✗	✓	✓	✗
-502C	✓	✗	✗	✗	✗	✗

NIBBLERS AND SHEARS

See index pages 142 - 143



SCAN HERE FOR MORE INFORMATION AND/ OR SEE PAGE 93 FOR RELATED SYSTEM ATTACHMENTS



	M18 FNB35	M12 FNB16	M18 BMS12	M18 BMS20
Platform	M18 FUEL™	M12 FUEL™	M18™	M18™
ONE-KEY™	ONE-KEY™	-	-	-
Cutting width (mm)	6.35	5	-	-
Max. cutting capacity aluminium (mm)	-	-	2.0	3.2
Max. cutting capacity steel (mm)	-	-	1.2	2.0
Max. sheet thickness aluminium up to 250 N/mm ² (mm)	3.8	2.1	-	-
Max. sheet thickness steel 400 N/mm ² (mm)	3.5	1.6	-	-
Max. sheet thickness steel 600 N/mm ² (mm)	2.8	1.2	-	-
Max. sheet thickness steel 800 N/mm ² (mm)	2.0	0.7	-	-
No load stroke rate (spm)	0 - 1,200	1,400 - 2,200	0 - 2,500	0 - 2,500
Smallest radius (mm)	57	40.7	-	-
Starting hole diameter (mm)	35	21	-	-
Weight with battery pack (EPTA) (kg)	4.2 (M18 B5)	1.6 (M12 B6)	2.3 (M18 B2)	2.3 (M18 B2)
Available versions				
-0	✓	✓	✓	✓
-0X	✓	✓	✗	✗
-402X	✗	✓	✗	✗
-502X	✓	✗	✗	✗

MITRE SAW LEGSTANDS, TABLE SAW AND PIPE STAND

See index page 141



SCAN HERE FOR MORE INFORMATION AND/ OR SEE PAGE 112 FOR RELATED SYSTEM ATTACHMENTS



	MSL 1000	MSL 2000	MSL 3000	MSUV 280	TSS 1000	MPS
Height (mm)	850	860	810	850	559	920
Base size (mm)	1,065	1,093	1,100	1,160	578	400x600
Extendable up to (mm)	2,125	2,542	3,000	2,800	-	-
Collapsed size (mm)	1,065	1,093	1,200	1,320	-	1,250
Bearing force (kg)	180	227	250	136	82	480
Weight (kg)	17.0	14.0	23.0	27.0	6.6	22.7

MITRE SAWS AND TABLE SAW

See index page 141



SCAN HERE FOR MORE INFORMATION



	M18 FMS305	M18 FMS254	M18 FMS190	M18 FTS210
Platform	M18 FUEL™	M18 FUEL™	M18 FUEL™	M18 FUEL™
ONE-KEY™	ONE-KEY™	-	-	ONE-KEY™
No load speed (rpm)	3,600	4,000	5,000	6,300
Blade diameter (mm)	305	254	190	210
Bevel capacity (°)	-	-	-	47
Bevel capacity left (°)	48	48	48	-
Bevel capacity right (°)	48	48	48	-
Mitre capacity left (°)	55	50	48	-
Mitre capacity right (°)	60	60	48	-
Bore size (mm)	30	30	30	30
Max. cutting capacity at fence 90° mitre / 90° bevel (mm)	96.5 x 340	91 x 289	-	-
Max. cutting depth 45° (mm)	-	-	-	44
Max. cutting depth 90° (mm)	-	-	-	63.5
Weight with battery pack (EPTA) (kg)	22.5 (M18 FB12)	20.0 (M18 B5)	12.7 (M18 B5)	22.3 (M18 FB12)
Available versions				
-0	✓	✓	✓	✓
-121	✓	✗	✗	✗
-121B	✗	✗	✗	✓

CORDED CIRCULAR SAWS

See index pages 145 - 146



SCAN HERE FOR MORE INFORMATION AND/ OR SEE PAGE 101 FOR RELATED SYSTEM ATTACHMENTS



	CS 85 SB	CS 85 CBE	SCS 65 Q	CS 60
Platform	Corded	Corded	Corded	Corded
Power input (W)	2,200	2,200	1,900	1,600
No load speed (rpm)	4,500	4,500	5,800	5,800
Blade diameter (mm)	235	235	190	184
Bevel capacity (°)	50	60	0 - 45	0 - 56
Max. cutting depth 45° (mm)	67	67	52	49
Max. cutting depth 90° (mm)	85	85	65	61
Guiderail compatible	No	Yes	No	No
Max. cutting depth with guiderail [mm]	-	81	-	-
Max. cutting depth with guiderail 45° [mm]	-	63	-	-
Weight (kg)	6.6	7.7	5.5	4.8

PLUNGE SAW AND CIRCULAR SAWS

See index pages 145 - 146



SCAN HERE FOR MORE INFORMATION AND/ OR SEE PAGE 101 FOR RELATED SYSTEM ATTACHMENTS



	M18 FPS55	M18 FCS552	M18 FCSDC165	M18 FCSRH662	M18 FCS66GR3	M18 FCS0190GR	M18 BLCS66	HD18 CS	M12 FCS442
Platform	M18 FUEL™	M18 FUEL™	M18 FUEL™	M18 FUEL™	M18 FUEL™	M18 FUEL™	M18™	M18™	M12 FUEL™
Technology	HIGH OUTPUT™	HIGH OUTPUT™	HIGH OUTPUT™	FORGE™	FORGE™	FORGE™	Brushless	-	HIGH OUTPUT™
Feature	-	-	-	-	-	AUTOSTOP™	-	-	-
ONE-KEY™	-	-	-	-	-	ONE-KEY™	-	-	-
No load speed (rpm)	2,500 - 5,600	6,000	6,000	6,000	6,000	6,000	5,000	3,500	3,850
Blade diameter (mm)	165	165	165	190	190	190	190	165	140
Bevel capacity (°)	-1 - 48	50	-5° to 45°	53	50	50	0 - 50	50	0 - 50
Max. cutting depth 45° (mm)	44	44	46	51	53	53	48	39	32
Max. cutting depth 90° (mm)	57	57	66	67	68	68	66	55	46
Guiderail compatible	Yes	No	Yes	No	Yes	Yes	No	No	No
Max. cutting depth with guiderail [mm]	55	-	61	-	64	64	-	-	-
Max. cutting depth with guiderail 45° [mm]	42	-	41	-	49	49	-	-	-
Weight with battery pack (EPTA) (kg)	4.9 (M18 HB5.5)	3.4 (M18 HB3)	3.4 (M18 HB3)	5.2 (M18 FB12)	5.7 (M18 FB12)	5.7 (M18 FB12)	4.0 (M18 B5)	3.8 (M18 B4)	2.4 (M12 HB5)
Available versions									
-0	✓	✓	✓	✓	✓	✓	✓	✓	✓
-0C	✓	✓	✓	✓	✓	✓	✓	✓	✓
-0P	✓	✓	✓	✓	✓	✓	✓	✓	✓
-0X	✓	✓	✓	✓	✓	✓	✓	✓	✓
-302X	✓	✓	✓	✓	✓	✓	✓	✓	✓
-402B	✓	✓	✓	✓	✓	✓	✓	✓	✓
-502X	✓	✓	✓	✓	✓	✓	✓	✓	✓
-552C	✓	✓	✓	✓	✓	✓	✓	✓	✓
-552P	✓	✓	✓	✓	✓	✓	✓	✓	✓
-121C	✓	✓	✓	✓	✓	✓	✓	✓	✓

SAWZALL™, HACKZALL™

See index page 151



SCAN HERE FOR MORE INFORMATION AND/ OR SEE PAGE 92 FOR RELATED SYSTEM ATTACHMENTS



	M18 ONEFSZ	M18 FSZ	M18 FSX	M18 BSX	SSPE 1500 X	SSPE 1300 RX	SSPE 1300 SX	SSD 1100 X	M18 FHZ	M12 CHZ	C18 HZ	C12 HZ
Platform	M18 FUEL™	M18 FUEL™	M18 FUEL™	M18™	Corded	Corded	Corded	Corded	M18 FUEL™	M12 FUEL™	M18™	M12™
ONE-KEY™	ONE-KEY™	-	-	-	-	-	-	-	-	-	-	-
Power input (W)	-	-	-	-	1,500	1,300	1,300	1,100	-	-	-	-
No load stroke rate (spm)	0 - 3,000	0 - 3,000	0 - 3,000	0 - 3,000	0 - 2,800	0 - 3,000	0 - 2,800	0 - 2,900	0 - 3,000	0 - 3,000	0 - 3,000	0 - 3,000
Stroke length (mm)	32	32	32	28.6	32	32	32	28	22	15.9	20	13
FIXTEC™ blade change	Yes	Yes	Yes	Yes	Yes	Yes	Yes	Yes	Yes	Yes	Yes	Yes
Orbital action	Yes	Yes	Yes	No	Yes	No	No	No	No	No	No	No
Weight (kg)	3.8 (M18 B5)	3.8 (M18 B5)	5.06 (M18 FB8)	4.0 (M18 B4)	4.5	4.2	3.9	3.2	2.6 (M18 B5)	1.6 (M12 B4)	2.5 (M18 B4)	1.2 (M12 B2)
Available versions												
-0	✓	✓	✓	✓	✓	✓	✓	✓	✓	✓	✓	✓
-0C	✓	✓	✓	✓	✓	✓	✓	✓	✓	✓	✓	✓
-0X	✓	✓	✓	✓	✓	✓	✓	✓	✓	✓	✓	✓
-402C	✓	✓	✓	✓	✓	✓	✓	✓	✓	✓	✓	✓
-502X	✓	✓	✓	✓	✓	✓	✓	✓	✓	✓	✓	✓
-801C	✓	✓	✓	✓	✓	✓	✓	✓	✓	✓	✓	✓

MULTI-TOOLS

See index pages 141 - 142



SCAN HERE FOR MORE INFORMATION



	M18 FMT	M18 BMT	M12 FMT	C12 MT
Platform	M18 FUEL™	M18™	M12 FUEL™	M12™
No load speed (rpm)	10,000 - 20,000	12,000 - 18,000	10,000 - 20,000	5,000 - 20,000
Oscillation angle left/ right (°)	2.1	1.7	1.8	1.5
FIXTEC™ blade change	Yes	Yes	Yes	No
Weight with battery pack (EPTA) (kg)	1.9 (M18 B5)	1.7 (M18 B2)	1.6 (M18 B2)	1.0 (M12 B2)
Available versions				
-0	✓	✓	✓	✓
-0X	✓	✓	✗	✗
-202B	✗	✗	✗	✓
-402B	✗	✗	✗	✓
-421C	✗	✓	✗	✗
-422X	✗	✗	✓	✗
-502X	✓	✗	✗	✗

JIGSAWS

See index pages 139 - 140



SCAN HERE FOR MORE INFORMATION AND/ OR SEE PAGE 92 FOR RELATED SYSTEM ATTACHMENTS



	M18 FBJS	M18 FJS	M12 FJS	M18 BJS	FSPE 110 X	JSPE 135
Platform	M18 FUEL™	M18 FUEL™	M12 FUEL™	M18™	Corded	Corded
Bevel capacity (°)	45	45	45	45	45	45
Max. cutting capacity wood/ steel/ aluminium (mm)	100/ 10/ 19	100/ 10/	70/ 3/ 3	135/ 10/	120/ 10/ 30	135/ 10/ 30
No load stroke rate (spm)	800 - 3,500	0 - 3,500	800 - 3,000	0 - 2,800	500 - 3,000	800 - 3,000
Stroke length (mm)	25	25	22	25	26	26
Pendulum action	Yes	Yes	Yes	Yes	Yes	Yes
Pendulum settings	4	4	5	5	4	4
Power input (W)	-	-	-	-	710	750
Weight (kg)	2.8 (M18 B5)	2.9 (M18 B5)	1.7 (M12 B2)	2.5 (M18 B4)	2.5	2.5
Available versions						
-0	✓	✓	✓	✓	✗	✗
-0X	✓	✓	✗	✓	✗	✗
-402C	✗	✗	✗	✓	✗	✗
-422X	✗	✗	✓	✗	✗	✗
-502X	✓	✓	✗	✗	✗	✗

PLANER, ROUTERS, ROTARY TOOLS

See index page 145



SCAN HERE FOR MORE INFORMATION AND/ OR SEE PAGES 102 & 111 FOR RELATED SYSTEM ATTACHMENTS



	M18 BP	M12 BLP	M18 FTR8	M18 FR12	M12 BLROT	C12 RT
Platform	M18™	M12™	M18 FUEL™	M18 FUEL™	M12™	M12™
Technology	-	Brushless	-	-	-	-
Collet capacity (mm)	-	-	8	12.7	3.2	3.2
Cutting width (mm)	82	51	-	-	-	-
Max. cutting depth (mm)	2	2	-	-	-	-
No load speed (rpm)	14,000	14,500	31,000	12,000 - 25,000	5,000 - 27,500	5,000 - 32,000
Plunge capacity (mm)	-	-	50	60	-	-
Rebate depth (mm)	10.7	17.5	-	-	-	-
Speed settings	-	-	6	6	12	6
Weight with battery pack (EPTA) (kg)	2.7 (M18 B4)	1.92 (M12 B4)	2.1 (M18 B5)	5.7 (M18 HB5.5)	0.56 (M12 B2)	0.60 (M12 B2)
Available versions						
-0	✓	✗	✗	✗	✓	✓
-0P	✗	✗	✗	✓	✗	✗
-0X	✗	✓	✓	✓	✗	✗
-402C	✓	✗	✗	✗	✗	✗
-402X	✗	✗	✗	✗	✓	✗

RADIOS AND SPEAKERS

See index page 149



SCAN HERE FOR MORE INFORMATION



	M18 PRCDAB+	M18 RC	M18 RADDAB+G2	M18 SPEJSG2	M12 RCDAB+	M12 SPEJSG2
Platform	M18™	M18™	M18™	M18™	M12™	M12™
Feature	DAB+	-	DAB+	-	DAB+	-
Frequency (Hz)	87.5 - 108	87.5 - 108	87.5 - 108	-	87.5 - 108	-
Bluetooth®	Yes	Yes	Yes	Yes	Yes	Yes
Charging function	Yes	Yes	No	No	Yes	No
USB C port	No	No	Yes	Yes	No	Yes
Audio link	No	No	No	Yes	No	Yes
PACKOUT™ compatible	Yes	No	No	No	No	Yes
Application	Large and outdoor spaces			Small - medium spaces		
Available versions						
-0	✓	✓	✓	✓	✓	✓

NAILERS AND STAPLERS

See index page 142



SCAN HERE FOR MORE INFORMATION AND/OR SEE PAGE 92 FOR RELATED SYSTEM ATTACHMENTS



	M18 FFN21	M18 FFN	M18 FFNS	M18 FN18GS	M18 FN16GA	M18 FN16GS	M18 FN15GA	M12 FCN18GS	M18 FFUS	M18 FNCS18GS	M12 BCST	M12 BST	M18 FDN	M18 FRCN45	C12 PN
Platform	M18 FUEL™	M18 FUEL™	M18 FUEL™	M18 FUEL™	M18 FUEL™	M18 FUEL™	M18 FUEL™	M12 FUEL™	M18 FUEL™	M18 FUEL™	M12™	M12™	M18 FUEL™	M18 FUEL™	M12™
Type	Framing nailer	Framing nailer	Framing nailer	Finishing nailer	Finishing nailer	Finishing nailer	Finishing nailer	Finishing nailer	Fencing utility stapler	Finishing nailer	Stapler	Stapler	Formwork nailer	Roofing coil nailer	Compact nailer
Collation angle (°)	20 - 22	30 - 34	30 - 34	0	20	0	34	0	0	0	0	0	21°	15°	-
Nail diameter (mm)	2.8 - 3.8	2.8 - 3.3	2.8 - 3.3	1.2	1.6	1.6	1.8	1.2	4	-	-	-	3.3	3	-
Nail type (mm)	50 - 90	50 - 90	50 - 90	16 / 54	32 - 64	25 - 64	32 - 64	16 - 38	-	-	-	-	73 - 92	19 - 45	90
Staple strip length (mm)	-	-	-	-	-	-	-	-	38 - 51	9.5 - 38	25.4	6 - 14	-	-	-
Staple strip width (mm)	-	-	-	-	-	-	-	-	10.3	5.7 - 6.35	19	10.6	-	-	-
Magazine capacity	43	51	51	110	110	110	110	110	45	108	45	89	44	120	-
Weight with battery pack (EPTA) (kg)	5.1 (M18 B5)	5.1 (M18 B5)	5.1 (M18 B5)	3.1 (M18 B2)	3.3 (M18 B2)	3.2 (M18 B2)	3.3 (M18 B2)	2.1 (M12 B2)	5.0 (M18 HB3)	2.8 (M18 B2)	2.3 (M12 B2)	1.6 (M12 B2)	5.1 (M18 B5)	3.8 (M18 HB3)	1.6 (M12 B2)
Available versions															
-0	x	x	x	✓	✓	x	x	x	x	x	✓	✓	x	x	✓
-0C	✓	✓	x	x	x	x	x	x	✓	x	x	x	✓	x	x
-0X	x	x	x	✓	✓	✓	✓	✓	x	✓	x	x	x	✓	x
-202X	x	x	x	✓	✓	x	x	✓	x	✓	x	✓	x	x	x
-302C	x	x	x	x	x	x	x	x	✓	x	x	x	x	x	x
-302X	x	x	x	x	x	x	x	x	x	x	x	x	x	✓	x
-502C	x	✓	✓	x	x	x	x	x	x	x	x	x	x	x	x

SHEET, DETAIL, BELT AND RANDOM ORBITAL SANDERS

See index pages 152 - 153



SCAN HERE FOR MORE INFORMATION AND/OR SEE PAGE 91 FOR RELATED SYSTEM ATTACHMENTS



	M18 BQSS	M12 FDSS	M18 FBTS75	BS 100 LE	M12 FBFL10	M12 FBFL13	M18 BOS125	M12 FSDR75	M18 FROS125	M12 FROS2.5	M12 FROS5	ROS 125 E
Platform	M18™	M12 FUEL™	M18 FUEL™	Corded	M12 FUEL™	M12 FUEL™	M18™	M12 FUEL™	M18 FUEL™	M12 FUEL™	M12 FUEL™	Corded
Power input (W)	-	-	-	1,150	-	-	-	-	-	-	-	300
Belt length (mm)	-	-	457	620	330	457	-	-	-	-	-	-
Belt width (mm)	-	-	75	100	10	13	-	-	-	-	-	-
Belt speed (m/min)	-	-	230 - 410	230 - 400	0 - 550 / 0 - 1,110	0 - 560 / 0 - 1,105	-	-	-	-	-	-
No load speed (rpm)	11,000 - 13,000	0 - 8,000 / 0 - 10,000 / 0 - 12,000 / 0 - 14,000	-	-	0 - 7,200 / 0 - 14,500	0 - 7,200 / 0 - 14,500	12,000	4,000 - 10,000	12,000	3,200 - 12,000	3,200 - 12,000	7,000 - 12,000
Oscillation rate (opm)	-	-	-	-	-	-	14,000 - 24,000	0 - 10,000	6,000 - 12,000	6,400 - 24,000	6,400 - 24,000	14,000 - 26,000
Oscillation diameter (mm)	1.6	1.5	-	-	-	-	2.4	2.5	2.38	2.5	5.0	2.4
Sanding pad size (mm)	113 x 104	88.8 x 63.5	90 x 135	100 x 160	330 x 10	457 x 13	125	75	127	150	150	125
Speed settings	6	4	5	6	2	2	6	4	5	8	8	6
Weight (kg)	1.9 (M18 B5)	0.8 (M12 B2)	4.6 (M18 HB5.5)	5.3	1.2 (M12 B4)	1.3 (M12 B4)	1.6 (M18 B5)	1.14 (M12 B2)	2.2 (M18 B5)	1.4 (M12 HB5)	1.4 (M12 HB5)	1.7
Available versions												
-0	✓	x	✓	x	✓	✓	✓	x	x	✓	✓	x
-0B	x	✓	x	x	x	x	x	✓	✓	x	x	x
-202B	x	x	x	x	x	x	x	✓	x	x	x	x
-402B	x	x	x	x	✓	✓	x	x	x	x	x	x
-422X	x	✓	x	x	x	x	x	x	x	x	x	x
-502B	✓	x	x	x	x	x	✓	x	x	x	x	x
-502X	x	x	x	x	x	x	x	x	✓	✓	✓	x
-552X	x	x	✓	x	x	x	x	x	x	x	x	x

DUST EXTRACTORS



SCAN HERE FOR MORE INFORMATION AND/ OR SEE PAGES 114 - 115 FOR RELATED SYSTEM ATTACHMENTS



See index page 133

	M18 ONEF2VC34M	M18 F2VC23LG2	M18 FVC23L	M18 FBPV2	M18 FPOVCL	M18 VC2	M18 CV	M12 FVCL	M12 HV
Platform	M18 FUEL™	M18 FUEL™	M18 FUEL™	M18 FUEL™	M18 FUEL™	M18™	M18™	M12 FUEL™	M12™
Technology	-	NEXUS™	NEXUS™	-	-	-	-	-	-
Feature	VACLINK™	VACLINK™	-	-	-	-	-	-	-
ONE-KEY™	ONE-KEY™	-	-	-	-	-	-	-	-
Compatible with	PACKOUT™	PACKOUT™	PACKOUT™	-	PACKOUT™	-	-	-	-
Wet/ dry	Both	Both	Both	Dry	Both	Both	Dry	Both	Dry
Air delivery AC (l/min)	2,550	-	-	-	-	-	-	-	-
Air delivery DC (l/min)	1,980	3,267	2,700	1,983	1,416	1,300	1,019	1,275	934
Vacuum AC (mbar)	199	-	-	-	-	-	-	-	-
Vacuum DC (mbar)	174	199	157	137	117	80	94	105	31.1
Capacity liquids (l)	17	20	20	-	7.0	7.5	-	6.1	-
Capacity solids (l)	28	23	23	3.8	9.5	9.79	1.35	5.7	0.6
Dust class	M	L	L	L	L	L	L	L	-
Filter type	HEPA H13	HEPA H13	HEPA H13	HEPA H13	HEPA	HEPA H13	Dry	HEPA H13	-
Hose diameter (mm)	36	48	48	48	31.75	41	32	41	22.5
Hose length (m)	3	2.75	2.75	0.66	1.83	0.47	1.2	0.5	-
Weight with battery pack (EPTA) (kg)	21.3 (2 x M18 FB12)	14.93 (2 x M18 FB12)	13.25 (1 x M18 FB12)	10.25 (M18 FB12)	5.9 (M18 B5)	5.3 (M18 B5)	1.9 (M18 B4)	5.0 (M12 B6)	1.2 (M12 B2)
Available versions									
-0	✓	✓	✓	✓	✓	✓	✓	✓	✓

CORDED DUST EXTRACTORS



SCAN HERE FOR MORE INFORMATION AND/ OR SEE PAGES 114 - 115 FOR RELATED SYSTEM ATTACHMENTS



See index page 133

	AS 42 MAC	AS 30 MAC	AS 30 LAC	AS 2-250 ELCP	AS 2-250EM	AS 2-250EH
Platform	Corded	Corded	Corded	Corded	Corded	Corded
Wet/ dry	Both	Both	Both	Both	Both	Both
Power input (W)	1,200	1,200	1,200	1,000	1,200	1,200
Air delivery AC (l/min)	4,500	4,500	4,500	3,600	3,720	3,720
Vacuum AC (mbar)	250	250	250	210	245	245
Capacity liquids (l)	30.5	19.5	19.5	18	18	18
Capacity solids (l)	42	30	30	21	21	21
Dust class	M	M	L	L	M	H
Filter type	PTFE	PTFE	PTFE	PET	PTFE	PTFE
Hose diameter (mm)	38	38	36	32	32	32
Hose length (m)	4	4	4	3.5	4	4
Weight (kg)	17.5	14.5	14.5	10.4	8.0	8

BLOWERS AND FANS FOR JOB SITE



SCAN HERE FOR MORE INFORMATION



See index pages 127 - 128

	M18 BBL	M18 BLHSB	M12 BBL	M18 ARFHP	M18 AFG2	M12 AF
Platform	M18™	M18™	M12™	M18™	M18™	M12™
Technology	-	Brushless	-	-	-	-
Airflow speed (km/h)	42.8/ 32.2/ 26.7	800	0 - 128/ 0 - 177	10.8/ 13.68/ 21.6	32.98	22.53
Air volume (m³/h)	-	-	-	3,058/ 4,075/ 5,775	1,444	300/ 450/ 680
Air volume (m³/min)	0 - 2.9/ 0 - 2.4/ 0 - 1.8	0 - 1.1/ 0 - 0.9/ 0 - 0.8	0 - 3.5/ 0 - 4.9	-	-	-
Fan speed (rpm)	0 - 18,700/ 0 - 15,300/ 0 - 11,400	0 - 74,000	0 - 11,000/ 0 - 15,000	-	-	-
Mounting	-	-	-	Handle	PACKOUT™, Screw holes, Handle	Screw holes, Clamp, Handle
Weight with battery pack (EPTA) (kg)	1.9 (M18 B5)	2.25 (M18 FB12)	1.9 (M12 B2)	8.4 (M18 B5)	2.61 (M18 B5)	2.3 (M12 B2)
Available versions						
-0	✓	✓	✓	✓	✓	✓

INFLATORS



SCAN HERE FOR MORE INFORMATION



See index page 139

	M18 FAC	M18 BI	M12 BI
Platform	M18 FUEL™	M18™	M12™
Airflow (l/min)	48	-	-
Duty cycle	-	33% @ 5.5 bar	50% at 10 min On and 10 min Off
Hose length (mm)	-	920	660
Max. pressure (bar / PSI)	9.31/ 135	10.3/ 150	8.27 / 120
No load air delivery (l/min)	-	40	24.9
Tank capacity (l)	7.6	-	-
Weight with battery pack (EPTA) (kg)	15.7 (M18 HB12)	4.8 (M18 HB12)	1.6 (M12 B2)
Available versions			
-0	✓	✓	✓

TYRE BUFFER, JUMP STARTER



SCAN HERE FOR MORE INFORMATION



See index page 154

	M12 FTB	M18 JS2000
Platform	M12 FUEL™	M18™
Diesel engine rated (l)	-	3.0
Max. buffing accessories diameter (mm)	80	-
Max. drilling accessories diameter (mm)	9.5	-
No load speed (rpm)	0 - 1,200/ 0 - 2,500	-
Overheat protection	-	Yes
Override warning	-	Yes
Peak current (A)	-	2,000
Petrol engine rated (l)	-	8.1
Reverse polarity protection	-	Yes
Spark proof	-	Yes
Tool reception	7/16" Hex	-
Weight with battery pack (EPTA) (kg)	1.1 (M12 B2)	3.4 (M18 B5)
Available versions		
-0	✓	✓

HEAT GUNS



SCAN HERE FOR MORE INFORMATION



See index pages 136 - 137

	M18 BHG	M12 SI
Platform	M18™	M12™
Air volume (l/min)	170	-
Heater power (W)	-	90
Recommended ambient operating temperature (°C)	-18 - +52	-
Temperature range (°C)	470	400
Weight with battery pack (EPTA) (kg)	1.4 (M18 B5)	0.50 (M12 B2)
Available versions		
-0	✓	✓
-201C	✗	✓
-502C	✓	✗

AUTOMOTIVE INSPECTION CAMERAS



SCAN HERE FOR MORE INFORMATION AND/ OR SEE PAGE 112 FOR RELATED SYSTEM ATTACHMENTS



See index page 126

	M12 APB	M12 ATB
Platform	M12™	M12™
Camera cable length (mm)	1,500	900
Camera head diameter (mm)	5	5
Camera head ingress protection (IP)	67	67
Display resolution (pixels)	1,280 x 720	480 x 272
Display size (Inch)	5.5	4.3
Image zoom	4x	4x
Storage temperature range (°C)	-20 ~ +60	-20 ~ +60
Weight with battery pack (EPTA) (kg)	1.2 (M12 B2)	0.75 (M12 B2)
Available versions		
-0C	✓	✓

LASERS



SCAN HERE FOR MORE INFORMATION AND/ OR SEE PAGE 116 FOR RELATED SYSTEM ATTACHMENTS

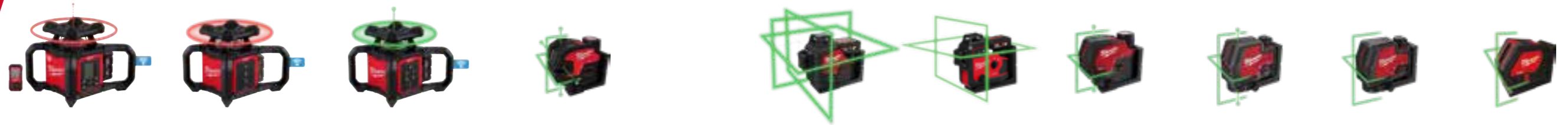

See index page 140

	M18 RLOHV1200	M18 RLOH600	M18 RLOHVG300	M12 CLL4P	M12 3PL	M12 A3PLO	M12 CLLP	L4 CLLP	L4 CLL	CLL
Platform	M18™	M18™	M18™	M12™	M12™	M12™	M12™	REDLITHIUM™ USB	REDLITHIUM™ USB	4 x AA Alkaline Batteries
ONE-KEY™	ONE-KEY™	ONE-KEY™	ONE-KEY™	-	-	-	-	-	-	-
Type	Rotary laser	Rotary laser	Rotary laser	Cross line laser with 4 plumb points	3 Plane laser	Cross line laser with 4 plumb points	Cross line laser with plumb points	Cross line laser with plumb points	Cross line laser	Cross line laser
Accuracy (mm/m)	-	-	-	0.3	0.3	0.3	0.3	0.3	0.3	0.3
Accuracy at 30 m distance (+/- mm)	1.6	2.4	1.6	-	-	-	-	-	-	-
Auto levelling	Yes	Yes	Yes	Yes	Yes	Yes	Yes	Yes	Yes	Yes
IP protection class	IP 66	IP 66	IP 66	IP 54	IP 54	IP 54	IP 54	IP 54	IP 54	IP 54
Laser classification	Class 2	Class 2	Class 2	Class 2	Class 2	Class 2	Class 2	Class 2	Class 2	Class 2
Colour of laser line	Red	Red	Green	Green	Green	Green	Green	Green	Green	Green
Self-levelling range (°)	+/- 5	+/- 5	+/- 5	4	4	4	4	4	4	4
Weight with battery pack (EPTA) (kg)	4.1 (M18 B5)	3.8 (M18 B2)	4.1 (M18 B5)	1.3 (M12 B3)	1.5 (M12 B4)	2.13 (M12 B4)	1.2 (M12 B3)	0.90 (L4 B3)	0.90 (L4 B3)	0.7 (4 x AA)
Compatible laser detector	RD1200/ RD600/ LRD100	RD600 / RD1200 / LRD100	RD300/ LRD100	LLD50 / LRD100	LLD50 / LRD100	Detector M12 A3PLO	LLD50 / LRD100	LLD50 / LRD100	LLD50 / LRD100	LLD50 / LRD100
Working range detector (m)	1,200	600	300	50 / 100	50 / 100	50	50 / 100	50 / 100	50 / 100	50
Indoor/ outdoor use	Outdoor	Outdoor	Both	Indoor	Indoor	Both	Indoor	Indoor	Indoor	Indoor
Available versions										
-0	✗	✗	✗	✗	✗	✗	✗	✗	✗	✗
-0C	✗	✗	✗	✓	✓	✓	✓	✗	✗	✗
-201C	✗	✓	✗	✗	✗	✗	✗	✗	✗	✗
-301C	✗	✗	✗	✓	✗	✗	✓	✓	✓	✗
-401C	✗	✗	✗	✗	✓	✓	✗	✗	✗	✗
-401P	✗	✗	✗	✗	✓	✗	✗	✗	✗	✗
-501C	✓	✗	✓	✗	✗	✗	✗	✗	✗	✗
Alkaline	✗	✗	✗	✗	✗	✗	✗	✗	✗	✓

ROTARY LASER DETECTORS



SCAN HERE FOR MORE INFORMATION



See index page 150

	RD1200	RD600	RD300G	LRD100	LLD50
Platform	2 x AA Alkaline Batteries	2 x AA Alkaline Batteries	2 x AA Alkaline Batteries	1 x AA Alkaline Battery	1 x AA Alkaline Battery
Accuracy (mm)	±0,5/±1,0/±2,0±3,0/±5,0	±0,5/±1,0/±2,0±3,0/±5,0	±0,5/±1,0/±2,0±3,0/±5,0	±0,5/±1,0/±2,0/±5,0/±10,0	±0,75/±1,0
Compatible with	M18 RLOHV1200, M18 RLOH600	M18 RLOH600, M18 RLOHV1200	M18 RLOHVG300	M18 RLOHVG300, M18 RLOH600, M18 RLOHV1200, M12 A3PLO, M12 3PL, M12 CLLP4, CLL, M12 CLLP, L4 CLL, L4 CLLP	M12 A3PLO, M12 3PL, M12 CLLP4, CLL, M12 CLLP, L4 CLL, L4 CLLP
IP protection class	67	67	67	67	54
Weight with battery pack (EPTA) (kg)	0.41	0.41	0.41	0.19	0.23
Working range detector (m)	1,200	600	300	0-100/ 0-250	0-50
Available versions					
Alkaline	✓	✓	✓	✓	✓

LASER DISTANCE METERS



SCAN HERE FOR MORE INFORMATION



See index page 140

	LDM 100	LDM 50	LDM 45	LDM 30
Platform	2 x AAA Alkaline Batteries	2 x AAA Alkaline Batteries	2 x AAA Alkaline Batteries	2 x AAA Alkaline Batteries
Accuracy	±1,5	±1,5	± 1,5	± 2
Auto-level measurements	Yes	No	No	No
Dimensions (Outer)(H x W x D / mm)	113 x 48 x 31	119 x 40 x 32	105 x 48 x 24	101 x 38 x 28
Display	LCD	LCD	LCD	LCD
Display size (mm)	31.5 x 40	26 x 37	31.5 x 40	25 x 25
Height tracking	Yes	No	No	Yes
Inclination sensor	Yes	No	No	No
Pythagoras function	Yes	2-point, 3-point, partial height	No	No
IP protection class	54	IP 54	54	IP 54
Laser classification	Class 2	Class 2	Class 2	Class 2
Max. measurement range (m)	100	50	45	30
Range (m)	0.15 - 100	0.05 - 50	0.15 - 45	0.15 - 30
Thread size (inch)	1/4"	1/4"	1/4"	1/4"
Weight with battery pack (EPTA) (kg)	0.14 (2 x AAA)	0.1 (2 x AAA)	0.11 (2 x AAA)	0.10 (2 x AAA)
Available versions				
Alkaline	✓	✓	✓	✓

CABLE CUTTING

See index page 128



SCAN HERE FOR MORE INFORMATION AND/ OR SEE PAGE 106 FOR RELATED SYSTEM ATTACHMENTS



	M18 ONEHCC	M18 HCC45	M18 HCC75R		M18 HCC75	M18 HCC125	M18 HSFC125R	M12 CC
Platform	M18™	M18™	M18™		M18™	M18™	M18™	M12™
Technology	FORCE LOGIC™	FORCE LOGIC™	FORCE LOGIC™		FORCE LOGIC™	FORCE LOGIC™	FORCE LOGIC™	-
ONE-KEY™	ONE-KEY™	ONE-KEY™	ONE-KEY™		ONE-KEY™	ONE-KEY™	ONE-KEY™	-
Shape	In-line	Pistol	In-line		In-line	In-line	In-line	Pistol
Remote controlled	No	No	Yes		No	No	Yes	No
Cutting force (kN)	53	77.8	77.8		77.8	120	120	32
Max. cutting diameter (mm)	35	44	75		75	125	125	32
Weight with battery pack (EPTA) (kg)	3.7 (M18 B2)	6.0 (M18 B2)	7.9 (M18 B5)		7.9 (M18 B5)	16.0 (M18 HB8)	16.0 (M18 HB8)	3.0 (M12 B2)
Available versions								
-0	x	x	x		x	x	x	✓
-0C	✓	✓	x		✓	x	x	x
-201C	✓	x	x		x	x	x	x
-502C	x	x	✓		✓	x	x	x
-522C	x	✓	x		x	x	x	x
-801C	x	x	x		x	✓	x	x
-802C	x	x	x		x	x	✓	x

CABLE CRIMPING

See index page 128



SCAN HERE FOR MORE INFORMATION AND/ OR SEE PAGES 104 - 105 FOR RELATED SYSTEM ATTACHMENTS



	M18 HCCT	M18 ONEHCCT60	M18 HCCT109/42	M18 HDCT
Platform	M18™	M18™	M18™	M18™
Technology	FORCE LOGIC™	FORCE LOGIC™	FORCE LOGIC™	FORCE LOGIC™
ONE-KEY™	ONE-KEY™	ONE-KEY™	ONE-KEY™	ONE-KEY™
Crimping style	Scissors	Linear	Linear	Dieless
Crimping force (kN)	53	60	109	-
Crimping range (mm²)	16 - 300	6 - 300	16 - 400	10 - 300
Weight with battery pack (EPTA) (kg)	3.7 (M18 B2)	3.8 (M18 B2)	5.6 (M18 B2)	4.5 (M18 B2)
Available versions				
-0C	x	✓	x	✓
-201C	✓	x	x	x
-202C	x	✓	x	✓
-522C	x	x	✓	x

HYDRAULIC PUMPS

See index page 137



SCAN HERE FOR MORE INFORMATION AND/ OR SEE PAGE 108 FOR RELATED SYSTEM ATTACHMENTS



	M18 HUP700	M18 HMP700
Platform	M18™	M18™
Technology	FORCE LOGIC™	FORCE LOGIC™
ONE-KEY™	ONE-KEY™	-
Auto retract	Yes	No
Remote controlled	Yes	No
Flow rate high pressure (l/min)	0.42	0.16
Flow rate low pressure (l/min)	2.05	0.30
IP protection class	54	-
Coupler type	CEJN G ^{1/4}	CEJN G ^{3/8}
Max. pressure (bar / PSI)	700 / 10,000	700 / 10,000
Total oil volume (l)	1.6	1
Weight with battery pack (EPTA) (kg)	16.5 (M18 HB12)	5.7 (M18 B5)
Available versions		
-0	x	✓
-501	x	✓
-121	✓	x

KNOCKOUT PUNCH

See index page 140



SCAN HERE FOR MORE INFORMATION AND/ OR SEE PAGE 108 FOR RELATED SYSTEM ATTACHMENTS



	M18 HKP
Platform	M18™
Technology	FORCE LOGIC™
Max. material thickness (mm)	2.5 in stainless and 3.0 in mild steel
Max. punching diameter (mm)	100
Punching force (kN)	60
Weight with battery pack (EPTA) (kg)	2.3 (M18 B2)
Available versions	
-201C	✓

TEST & MEASUREMENT



SCAN HERE FOR MORE INFORMATION AND/ OR SEE PAGE 111 FOR RELATED SYSTEM ATTACHMENTS



See index page 154

	2205-40	2212-20	2216-40	2217-40	2235-40	2267-40
Platform	2 x AA Alkaline Batteries	2 x AAA Alkaline Batteries	2 x AA Alkaline Batteries	2 x AA Alkaline Batteries	2 x AA Alkaline Batteries	9V Block Battery
Continuity	Yes	Yes	Yes	Yes	Yes	-
Lo-Z measurement	Yes	-	No	Yes	No	-
Resistance (kΩ)	40	-	40,000	40,000	0.4	-
Safety rating	CAT IV 600 V / CAT III 1000 V	CAT IV 600 V	CAT III 600 V	600 V CAT III	CAT III 600 V	-
Temperature operating (°C)	0 - 50	-10 - 50	-10 - 50	-10 - 50	-10 - 50	0 - 50
Temperature storage (°C)	-40 - 60	-10 - 60	-40 - 60	-40 - 60	-40 - 60	-20 - 60
Current AC (A)	200	-	0.04 - 6/ 10	6 - 10	40 - 400	-
Current DC (A)	-	-	6 - 10	6 - 10	-	-
Voltage (AC) (V)	-	-	6.00 mV - 600	600 mV - 600	400/ 600	-
Voltage (DC) (V)	-	-	6.00 mV - 600	600 mV - 600	400/ 600	-
Voltage AC/DC (V)	400 - 1,000	600	-	600	600	-
Weight with battery pack (EPTA) (kg)	0.30 (2 x AA)	0.30 (2 x AAA)	0.40 (2 x AA)	0.40 (2 x AA)	0.30 (2 x AA)	0.30 (9V Block Battery)
Available versions						
Alkaline	✓	✓	✓	✓	✓	✓

CABLE PULLING



SCAN HERE FOR MORE INFORMATION AND/ OR SEE PAGE 107 FOR RELATED SYSTEM ATTACHMENTS



See index page 128

	M18 FPFT
Platform	M18 FUEL™
Max. tape length	72 steel tape/ 60 non-conductive tape
Power to pull [kg]	110
Min. pipe diameter [mm]	20
Weight with battery pack (EPTA) (kg)	6.4 (M18 B2)
Available versions	
-0	✓
-202	✓

CABLE CONNECTING



SCAN HERE FOR MORE INFORMATION



See index page 128

	M18 BSBT
Platform	M18™
Bolt adjustment range (mm)	20 - 78
Max. cable size (mm²)	1,000
Max. torque (Nm)	100
No load speed (rpm)	60
Tool reception	½" square
Weight with battery pack (EPTA) (kg)	2.9 (M18 B2)
Available versions	
-0X	✓
-202X	✓

VOLTAGE DETECTORS



SCAN HERE FOR MORE INFORMATION



See index page 154

	2225-20	NCVD	NCVDDF	NCVDF
Platform	2 x AAA Alkaline Batteries	2 x AAA Alkaline Batteries	2 x AAA Alkaline Batteries	2 x AAA Alkaline Batteries
Dual range	No	No	No	Yes
Integrated flashlight	No	No	Yes	Yes
Thermometer	Yes	No	No	No
Temperature range (°C)	-30 - 250	-	-	-
Temperature operating (°C)	0 - 50	0 - 50	0 - 50	0 - 50
Temperature storage (°C)	-10 - 50	-10 - 50	-10 - 50	-10 - 50
Voltage (AC) (V)	12 - 1,000	50 - 1,000	12 - 1,000/ 50 - 1,000	12 - 1,000/ 50 - 1,000
Safety rating	CAT IV 1000V AC	CAT IV 1000V	CAT IV 1000V	CAT IV 1000V
IP protection class	54	54	54	54
Drop protection (m)	2	2	2	2
Weight with battery pack (EPTA) (kg)	0.085 (2 x AAA)	0.058	0.061	0.061
Available versions				
Alkaline	✓	✓	✓	✓

CABLE STRIPPING



SCAN HERE FOR MORE INFORMATION



See index page 129

	M18 FCST
Platform	M18 FUEL™
Feature	AUTOSTOP™
ONE-KEY™	ONE-KEY™
Cable diameter range (mm)	12 - 54
Minimum stripping length (mm)	25
Stripping speed (mm/s)	25
Weight with battery pack (EPTA) (kg)	3.9 (M18 HB3)
Available versions	
-0C	✓
-302C	✓

SPECIALISED CUTTING TOOLS



SCAN HERE FOR MORE INFORMATION AND/ OR SEE PAGE 107 FOR RELATED SYSTEM ATTACHMENTS



See index page 153

	M18 BLTRC	M18 FRBC032
Platform	M18™	M18 FUEL™
Technology	Brushless	-
Feature	-	RAPIDSTOP™
ONE-KEY™	-	ONE-KEY™
No load speed (m/min)	-	2,000
Blade diameter (mm)	-	137
Weight with battery pack (EPTA) (kg)	3.9 (M18 B2)	4.0 (M18 B5)
Available versions		
-0X	✓	✓
-502X	✗	✓
-522X	✓	✗

PRESS TOOLS

See index pages 148 - 149



SCAN HERE FOR MORE INFORMATION AND/ OR SEE PAGES 87 - 90 FOR RELATED SYSTEM ATTACHMENTS



	M18 ONEBLHPT	M18 BLHPT	M18 BLHPTXL	M12 ONEHPT
Platform	M18™	M18™	M18™	M12™
Technology	FORCE LOGIC™	FORCE LOGIC™	FORCE LOGIC™	FORCE LOGIC™
ONE-KEY™	ONE-KEY™	-	-	ONE-KEY™
Press force (kN)	32	32	32	19
Max. press size multilayer MLCP pipe (mm)	75	75	75	40
Max. press size in c-steel & stainless steel (mm)	54	54	108	35
Max. press size in copper (mm)	108	108	108	35
Max. press size black iron steel (°)	2	2	4	-
Press cycles	40,000	40,000	40,000	37,000
Weight with battery pack (EPTA) (kg)	2.9 (M18 HB3)	2.9 (M18 B2)	3.9 (M18 B5)	1.9 (M12 B2)
Available versions				
-0C	✓	✓	✓	✓
-202C	✗	✓	✗	✓
-302C	✓	✗	✗	✗
-502C	✗	✗	✓	✗

PIPE THREADERS

See index page 144



SCAN HERE FOR MORE INFORMATION AND/ OR SEE PAGES 80 - 81 FOR RELATED SYSTEM ATTACHMENTS



	MXF PTR2	M18 FPT2	M18 FPT114
Platform	MX FUEL™	M18 FUEL™	M18 FUEL™
ONE-KEY™	ONE-KEY™	ONE-KEY™	ONE-KEY™
Feature	-	AUTOSTOP™	AUTOSTOP™
No load speed (rpm)	0 - 39/ 0 - 59	0 - 29/ 0 - 41	0 - 35
Speed settings	2	2	1
Thread size (inch)	1/8 - 2	1/8 - 2	1/8 - 1 1/4
Weight with battery pack (EPTA) (kg)	115 (MXF XC406)	11.3 (M18 HB12)	5.9 (M18 HB8)
Available versions			
-0	✓	✗	✗
-0C	✗	✓	✓
-601	✓	✗	✗
-802C	✗	✗	✓
-121C	✗	✓	✗

ELECTROFUSION PROCESSOR

See index page 133



SCAN HERE FOR MORE INFORMATION



	MXF EFP
Platform	MX FUEL™
IP protection class	IP54
Weight with battery pack (EPTA) (kg)	14.8 (MXF XC608)
Available versions	
-0	✓
-802	✓

VACUUM PUMP

See index page 154



SCAN HERE FOR MORE INFORMATION



	M18 FVP5
Platform	M18 FUEL™
Flow rate (l/min)	142
Intake ports	1/2, 3/8, 1/4
Oil capacity (ml)	500
Refrigerant classes	A1, A2L
Ultimate vacuum (microns)	25
Weight with battery pack (EPTA) (kg)	9.7 (M18 HB8)
Available versions	
-0	✓
-801	✓

ROLL GROOVERS

See index page 150



SCAN HERE FOR MORE INFORMATION



	M18 FRGR0	M18 FRGR02
Platform	M18 FUEL™	M18 FUEL™
Pipe diameter (DN)	32 - 100	50 - 150
Pipe diameter (°)	1 1/4 - 4	2 - 6
Pipe diameter (mm)	42.4 - 114.3	60.3 - 168.3
Pipe wall thickness (mm)	2.6 - 5.6	2.6 - 7.1
Weight with battery pack (EPTA) (kg)	19.8 (M18 FB8)	20.2 (M18 FB12)
Available versions		
-0C	✓	✓
-802C	✓	✗
-122C	✗	✓

STRUT SHEAR

See index page 154



SCAN HERE FOR MORE INFORMATION AND/ OR SEE PAGE 107 FOR RELATED SYSTEM ATTACHMENTS



	M18 STS0
Platform	M18™
Technology	FORCE LOGIC™
ONE-KEY™	ONE-KEY™
Cuts per battery	200
Cutting capacity (mm)	41x41; 41x22; 41x21
Cutting time (s)	<5
Weight with battery pack (EPTA) (kg)	11.6 (M18 B5)
Available versions	
-0B	✓

PIPE CUTTERS

See index page 144



SCAN HERE FOR MORE INFORMATION AND/ OR SEE PAGE 106 FOR RELATED SYSTEM ATTACHMENTS



	M18 FPCS	M12 PCSS54	M12 PCSS	C12 PPC	C12 PC
Platform	M18 FUEL™	M12™	M12™	M12™	M12™
Length (mm)	350	322	362	365	360
Max. cutting capacity (mm)	33.7	54	28	50	28
Max. cutting capacity steel (mm)	33.7	54	28	-	-
Minimum space for tube cutting (mm)	63.5	43	40	-	40
No load speed (rpm)	8,700	330	380	0 - 500	0 - 500
Pipe diameter (mm)	0 - 33.7	35, 42, 54	12, 15, 18, 22, 28	12 - 50	12, 15, 18, 22, 25, 28
Pipe wall thickness (mm)	-	1.5	1.5	-	-
Weight with battery pack (EPTA) (kg)	3.7 (M18 B5)	3.1 (M12 B4)	1.5 (M12 B2)	1.9 (M12 B2)	1.5 (M12 B2)
Available versions					
-0	✓	✓	✓	✓	✓
-202C	✗	✗	✓	✗	✗
-402C	✗	✓	✗	✗	✗
-502X	✓	✗	✗	✗	✗

EXPANDERS

See index pages 133 - 134



SCAN HERE FOR MORE INFORMATION AND/ OR SEE PAGE 109 FOR RELATED SYSTEM ATTACHMENTS



	M18 ONEBLXPXL	M18 FPXP	HD18 PXP	M12 FPXP	C12 PXP
Platform	M18™	M18 FUEL™	M18™	M12 FUEL™	M12™
Technology	FORCE LOGIC™	-	-	-	-
ONE-KEY™	ONE-KEY™	ONE-KEY™	-	-	-
Head type	Auto-rotating	Auto-rotating	Auto-rotating	Auto-rotating	Auto-rotating
Stroke length (mm)	55.5	31.1	25	14	14
Max. pipe diameter 10 bar (mm)	75 x 6.8	50 x 6.9	32 x 4.4	25 x 3.5	25 x 3.5
Max. pipe diameter 6 bar (mm)	75 x 6.8	50 x 4.6	40 x 3.7	32 x 2.9	32 x 2.9
Weight with battery pack (EPTA) (kg)	10.1 (M18 B5)	6.7 (M18 B5)	3.5 (M18 B2)	2.2 (M12 B2)	1.9 (M12 B2)
Available versions					
-0C	✗	✓	✗	✓	✗
-202C	✗	✗	✓	✓	✓
-502C	✓	✓	✗	✗	✗

DRAIN CLEANERS

See index pages 131 - 132



SCAN HERE FOR MORE INFORMATION AND/ OR SEE PAGE 84 FOR RELATED SYSTEM ATTACHMENTS



	MXF LSDP	M18 FFSDC16	M18 FFSDC13	M18 FFSDC10	M18 FDCPF10	M18 FDCPF8	M12 BDC8	M12 BDC6
Platform	MX FUEL™	M18 FUEL™	M18 FUEL™	M18 FUEL™	M18 FUEL™	M18 FUEL™	M12™	M12™
Autofeed	Yes	No	No	No	Yes	Yes	No	No
Bucket capacity (l)	-	-	-	-	23	23	22.5	22.5
Drain capacity (mm)	75 - 200	32 - 75	50 - 110	32 - 75	32 - 75	32 - 75	32 - 50	32 - 50
No load speed (rpm)	200	250	250	250	0 - 600	0 - 600	0 - 500	0 - 500
Spiral diameter (mm)	20	16	13	10	10	8	8	6
Spiral type	-	Open wind	Inner core	Inner core	Inner core	Inner core	Inner core	Inner core
Weight with battery pack (EPTA) (kg)	56.6 (MXF CP203)	13.4 (M18 B5)	13.4 (M18 B5)	13.4 (M18 B5)	6.9 (M18 B2)	6.9 (M18 B2)	4.8 (M12 B2)	4.2 (M12 B2)
Available versions								
-0	✗	✓	✓	✓	✗	✗	✗	✗
-0C	✗	✗	✗	✗	✓	✓	✓	✓
-201C	✗	✗	✗	✗	✓	✗	✗	✗
-202C	✗	✗	✗	✗	✗	✗	✗	✗
-301	✓	✗	✗	✗	✗	✗	✗	✗
-502	✗	✓	✗	✗	✗	✗	✗	✗

INSPECTION CAMERAS



SCAN HERE FOR MORE INFORMATION AND/ OR SEE PAGE 112 FOR RELATED SYSTEM ATTACHMENTS



See index page 139

	M18 SIC60SC HDR	M18 SIC60 HDR	M18 SIC36 HDR		M18 SIC30 HDR	M12 SIC026	M12 SIC020	M12 POSIC
Platform	M18™	M18™	M18™		M18™	M12™	M12™	M12™
Compatible with	-	-	-		-	-	-	PACKOUT™
ONE-KEY™	-	-	-		-	ONE-KEY™	ONE-KEY™	-
Cable diameter (mm)	10	12	9.5		9.5	7.25	6.5	5.5
Camera cable length (m)	60	60	36		30	26	20	23
Camera head diameter (mm)	25	34	25		25	16/ 20	16/ 20	18.5
Camera head ingress protection (IP)	67	67	67		67	67	67	67
Camera resolution (px)	720	720	720		720	1080	1080	720
Display size (Inch)	-	-	-		-	-	-	7
Drain capacity (mm)	50 - 160	75 - 250	50 - 160		40 - 160	32 - 100	32 - 75	32 - 100
Line trace frequency (k)(Hz)	33, 83	33, 83	33, 83		33, 83	-	-	-
Sonde frequency (k)(Hz)	512, 640, 33	512, 640, 33	512, 640, 33		512, 640, 33	512, 640	512, 640	-
Weight with battery pack (EPTA) (kg)	16.6	20.5	12.4		10.8	4.9 (M12 B2)	4.2 (M12 B2)	4.8 (M12 B2)
Smart HUB	M18 SISH	M18 SISH	M18 SISH		M18 SISH	Integrated HUB	Integrated HUB	Integrated HUB
Viewing device	M18 SIM, M18 SIM2, M12 SIM, Pipeline inspection App	M18 SIM2, M18 SIM, M12 SIM, Pipeline inspection App	M18 SIM2, M18 SIM, M12 SIM, Pipeline inspection App		M18 SIM2, M18 SIM, M12 SIM, Pipeline inspection App	M18 SIM2, M18 SIM, M12 SIM, Pipeline inspection App	M18 SIM2, M18 SIM, M12 SIM, Pipeline inspection App	Integrated screen
Available versions								
-0	✓	✓	✓		✓	✓	✓	✓

SECTIONAL SEWER MACHINES



SCAN HERE FOR MORE INFORMATION AND/ OR SEE PAGES 85 - 86 FOR RELATED SYSTEM ATTACHMENTS



See index page 152

	M18 FGSSM	M18 HSFSM	M12 HSFSM
Platform	M18 FUEL™	M18 FUEL™	M12™
ONE-KEY™	ONE-KEY™	ONE-KEY™	-
Drain capacity (mm)	32 - 160	32 - 110	32 - 50
Spiral diameter (mm)	16/ 22	8	6
Spiral length (m)	46	23	10.5
No load speed (rpm)	650	600 - 2,200	450 - 1,850
Weight with battery pack (EPTA) (kg)	14.0 (M18 HB12)	29.52 (M18 HB12)	9.9 (M12 B6)
Available versions			
-0	✓	✓	✓
-121	✓	✗	✗
-122	✗	✓	✗
-602	✗	✗	✓

SEWER INSPECTION MONITORS



SCAN HERE FOR MORE INFORMATION



See index page 152

	M18 SIM	M12 SIM
Platform	M18™	M12™
ONE-KEY™	ONE-KEY™	-
Touchscreen	Yes	Yes
Fits MILWAUKEE® inspection cameras	M18 SIC60SC HDR, M18 SIC60 HDR, M18 SIC36 HDR, M18 SIC30 HDR	M18 SIC60SC HDR, M18 SIC60 HDR, M18 SIC36 HDR, M18 SIC30 HDR, M12 SIC026, M12 SIC020
Weight with battery pack (EPTA) (kg)	2.8 (M18 B5)	1.1 (M12 B3)
Available versions		
-0	✓	✓

SMART HUB FOR SEWER MACHINES



SCAN HERE FOR MORE INFORMATION



See index page 153

	M18 SISH	M12 SIC0 BU
Platform	M18™	M12™
ONE-KEY™	ONE-KEY™	ONE-KEY™
Fits MILWAUKEE® inspection cameras	M18 SIC60 HDR, M18 SIC60SC HDR, M18 SIC36 HDR, M18 SIC30 HDR	M12 SIC026, M12 SIC020
IP protection class	54	-
Line trace frequency (k)(Hz)	33, 65, 83	-
SSD Harddrive (GB)	500	-
USB Drive	Yes	Yes
Video connection	MILWAUKEE® sewer inspection monitor or MILWAUKEE® pipeline inspection app with Android and IOS	MILWAUKEE® sewer inspection monitor or MILWAUKEE® pipeline inspection app with Android and IOS
Weight with battery pack (EPTA) (kg)	3.9 (M18 B5)	2.2 (M12 B2)
Available versions		
-0	✓	✓

PLUMBING LOCATOR AND INSPECTION CAMERAS

See index page 145



SCAN HERE FOR MORE INFORMATION AND/ OR SEE PAGE 112 FOR RELATED SYSTEM ATTACHMENTS



	M12 PL	M12 360IC12	M12 360IC32	AIC2
Platform	M12™	M12™	M12™	4 x AA Alkaline Batteries
ONE-KEY™	ONE-KEY™	-	-	-
Camera cable length (mm)	-	1,200	3,000	1,200
Camera head diameter (mm)	-	10	10	10
Camera head ingress protection (IP)	-	67	67	67
IP protection class	65	-	-	-
Display resolution (pixels)	480 x 272	480 x 272	480 x 272	480 x 272
Display size (Inch)	4.3	4.3	4.3	4.3
Image zoom	-	3x	3x	3x
Line trace frequency (k)(Hz)	33, 83	-	-	-
Sonde frequency (k)(Hz)	512, 640, 33	-	-	-
Storage temperature range (°C)	-18 ~ +50	-20 ~ +60	-20 ~ +60	-20 ~ +60
Weight with battery pack (EPTA) (kg)	2.6 (M12 B2)	0.88 (M12 B2)	1.19 (M12 B2)	0.71 (4 x AA)
Available versions				
-0C	✓	✓	✓	✗
-201C	✓	✓	✗	✗
Alkaline	✗	✗	✗	✓

LAWN MOWERS

See index page 140



SCAN HERE FOR MORE INFORMATION AND/ OR SEE PAGE 103 FOR RELATED SYSTEM ATTACHMENTS



	M18 F2LM46	M18 F2LM53
Platform	M18 FUEL™	M18 FUEL™
Decksize (cm)	46	53
Blade speed (rpm)	3,800	3,300
Collection bag capacity (l)	60	70
Cutting height [mm]	25 - 100	25 - 100
Drive mechanism	Self propelled	Self propelled
Self-propelled speed (km/h)	0 - 6.5	0.16 - 6.4
Rear wheel (Ø cm)	23.8	26.4
Front wheel (Ø cm)	18.8	20.3
Housing	Steel	Steel
Mulching capable	Yes	Yes
Mulching plug supplied	Yes	Yes
Weight with battery pack (EPTA) (kg)	34.7 (2 x M18 HB8)	38.5 (2 x M18 HB12)
Available versions		
-0	✓	✓
-802	✓	✗
-122	✗	✓

GRASS TRIMMERS, BRUSH CUTTERS, EDGERS

See index page 134



SCAN HERE FOR MORE INFORMATION AND/ OR SEE PAGE 103 FOR RELATED SYSTEM ATTACHMENTS



	M18 BLLT	M18 FOPH-LTA	M18 FOPH-BCA	M18 FBCU	M18 F2BCU	M18 FEDG	M18 FOPH-EA	M18 FOPH-RA
Platform	M18™	M18 FUEL™	M18™	M18 FUEL™	M18 FUEL™	M18 FUEL™	M18 FUEL™	M18™
Technology	-	QUIK-LOK™	QUIK-LOK™	-	-	-	QUIK-LOK™	QUIK-LOK™
Blade length (mm)	-	-	-	-	-	203	203	230
Cutting line diameter (mm)	2.0 / 2.4	2.0 / 2.4	-	2.0 / 2.4	2.0	-	-	-
Cutting path width (cm)	35 - 40	35 - 40	-	35 - 40	38 - 43	-	-	-
Cutting path width blade (cm)	-	-	23	23	26	-	-	-
Handle type	Loop handle	Loop handle	Loop handle	Bike handle	Bike handle	-	-	-
Line feed system	Fixed	Bump head	-	Bump head	Bump head	-	-	-
Max. cutting capacity (mm)	-	-	-	-	-	76	50	-
No load speed (rpm)	0 - 4,600 / 0 - 6,200	0 - 4,600 / 0 - 5,400 / 0 - 6,200	0 - 4,600 / 0 - 5,400 / 0 - 6,200	0 - 4,900 / 0 - 6,200	0 - 4,900 / 0 - 5,500	0 - 5,200	0 - 2,900 / 0 - 3,400 / 0 - 3,900	0 - 920 / 0 - 1,080 / 0 - 1,240
Power head required	-	M18 FOPH2	M18 FOPH2	-	-	-	M18 FOPH2	M18 FOPH2
Weight with battery pack (EPTA) (kg)	5.3 (M18 HB8)	1.7	1.6	6.5 (M18 HB12)	10.2 (2 x M18 FB12)	6.5 (M18 FB12)	2.4	2.4
Available versions								
-0	✓	✓	✓	✓	✓	✓	✓	✓
-802	✗	✗	✗	✓	✗	✗	✗	✗
-122	✗	✗	✗	✗	✓	✗	✗	✗

HEDGE TRIMMERS



SCAN HERE FOR MORE INFORMATION AND/ OR SEE PAGE 103 FOR RELATED SYSTEM ATTACHMENTS



See index page 137

	M18 FHET75G2	M18 FHET60G2	M18 FHETE27	M18 FHETE22		M18 FHETSP	M18 FOPH-HTA	M18 FOPH-SHTA	M12 FHT20
Platform	M18 FUEL™	M18 FUEL™	M18 FUEL™	M18 FUEL™		M18 FUEL™	M18 FUEL™	M18™	M12 FUEL™
Technology	-	-	-	-		-	QUIK-LOK™	QUIK-LOK™	-
Blade length (cm)	81	67	65	65		51	508	508	20
Cutting capacity (mm)	32	32	22	22		22	25	19	12.5
Cutting length (cm)	75	63	60	60		49	49	49	19.2
Stroke rate (spm)	3,200	3,200	3,500	3,500		3,500	3,500	3,500	2,700
Tooth spacing (mm)	32	32	25	25		25	25	25	14
Power head required	-	-	-	-		-	M18 FOPH2	M18 FOPH2	-
Weight with battery pack (EPTA) (kg)	5.6 (M18 FB8)	5.4 (M18 FB8)	6.9 (M18 FB8)	6.2 (M18 FB8)		5.6 (M18 FB8)	2.6	2.0	1.7 (M12 B4)
Available versions									
-0	✓	✓	✓	✓		✓	✓	✓	✓
-402	✗	✗	✗	✗		✗	✗	✗	✓
-802	✓	✓	✓	✓		✗	✗	✗	✗

CHAIN SAWS, PRUNING SAWS, TELESCOPIC POLE SAW



SCAN HERE FOR MORE INFORMATION AND/ OR SEE PAGE 102 FOR RELATED SYSTEM ATTACHMENTS

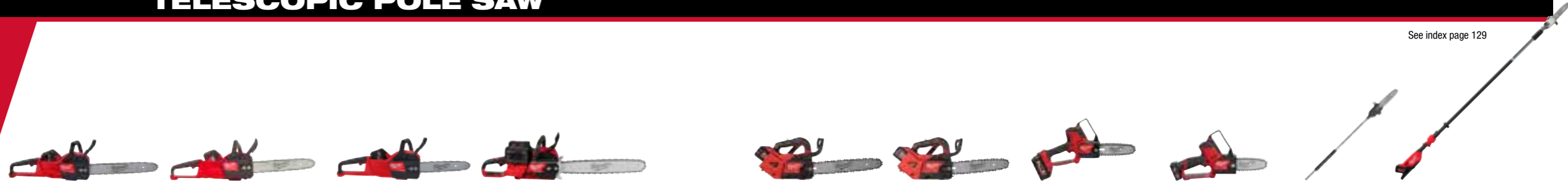

See index page 129

	M18 FCHS	M18 FCHS35	M18 FCHSC	M18 F2CHS50		M18 FTCHS35	M18 FTCHS30	M18 FHS20	M12 FHS	M18 FOPH-CSA	M18 FTFS30
Platform	M18 FUEL™	M18 FUEL™	M18 FUEL™	M18 FUEL™		M18 FUEL™	M18 FUEL™	M18 FUEL™	M12 FUEL™	M18 FUEL™	M18 FUEL™
Technology	-	-	-	-		-	-	-	-	QUIK-LOK™	-
Chainsaw type	Rear handle	Rear handle	Rear handle	Rear handle		Top handle	Top handle	Pruning	Pruning	Pole	Pole
Chain bar length (cm)	40	35	30	50		35	30	20	15	25.4	30
Chain gauge (mm/)	1.1 / 0.043	1.1 / 0.043	1.1 / 0.043	1.3 / 0.050		1.1 / 0.043	1.1 / 0.043	1.1 / 0.043	1.1 / 0.043	1.1 / 0.043	1.1 / 0.043
Chain oil tank capacity (ml)	200	200	200	169		200	200	77	50	140	130
Chain pitch (mm/)	9.5 / 3/8	9.5 / 3/8	9.5 / 3/8	8.3 / .325		8.3 / .325	8.3 / .325	9.5 / 3/8	9.5 / 3/8	9.5 / 3/8	8.3 / .325
Chain speed (m/s)	12.4	12.4	12.4	14.3		15	15	5.0	5	8.6	25.4
Power head required	-	-	-	-		-	-	-	-	M18 FOPH2	-
Extendable up to (mm)	-	-	-	-		-	-	-	-	2045	3980
Weight with battery pack (EPTA) (kg)	6.4 (M18 HB12)	6.4 (M18 HB12)	6.4 (M18 HB12)	9.0 (2x M18 FB8)		4.7 (M18 HB8)	4.7 (M18 HB8)	3.1 (M18 HB5.5)	2.3 (M12 B6)	1.9	8.3 (M18 HB12)
Available versions											
-0	✓	✓	✓	✓		✓	✓	✓	✓	✓	✓
-552	✗	✗	✗	✗		✗	✗	✓	✗	✗	✗
-602X	✗	✗	✗	✗		✗	✗	✗	✓	✗	✗
-802	✗	✗	✗	✓		✓	✓	✗	✗	✗	✗
-121	✗	✗	✗	✗		✗	✗	✗	✗	✗	✓
-122	✓	✓	✓	✗		✗	✗	✗	✗	✗	✗

BLOWERS

See index page 127



SCAN HERE FOR MORE INFORMATION AND/ OR SEE PAGE 103 FOR RELATED SYSTEM ATTACHMENTS



	MXF BPB	M18 FBLG3	M18 F2BPB	M18 F2BL	M18 FOPH-BA	M18 BLBLO
Platform	MX FUEL™	M18 FUEL™	M18 FUEL™	M18 FUEL™	M18™	M18™
Technology	-	-	-	-	QUIK-LOK™	Brushless
ONE-KEY™	ONE-KEY™	-	-	-	-	-
Air speed (km/h)	0 - 305	193	0 - 250	0 - 233	0 - 193	0 - 193
Air volume (m³/min)	0 - 23	14.2	0 - 18.5	0 - 17	0 - 14.2	12.7
Clearing force (N)	30	12.2	20.5	17.7	12.2	11
Cruise control	Yes	Yes	Yes	Yes	No	No
Variable speed	Yes	Yes	Yes	Yes	Yes	Yes
Power head required	-	-	-	-	M18 FOPH2	-
Weight with battery pack (EPTA) (kg)	13.8 (MXF HD812)	3.5 (M18 HB8)	11.4 (2x M18 HB12)	4.9 (M18 FB8)	2.1	3.1 (M18 HB5.5)
Available versions						
-0	✓	✓	✓	✓	✓	✓
-802	✗	✓	✗	✓	✗	✗
-122	✓	✗	✗	✗	✗	✗
-124	✗	✗	✓	✗	✗	✗

SPRAYERS

See index page 153



SCAN HERE FOR MORE INFORMATION AND/ OR SEE PAGE 103 FOR RELATED SYSTEM ATTACHMENTS



	M12 BHCS3L	M18 BBPFP2-CST	M18 BBPFP2-WST
Platform	M12™	M18™	M18™
Capacity (l)	3.7	15	15
Flow rate (l/min)	0.4 - 1.1	0.4 - 3.1	0 - 4.3
Hose length (m)	1.6	1.75	3
Power base	Integrated	M18 BBPFP2	M18 BBPFP2
Pressure (bar)	1.3 - 5.5	1.4 - 9.6	1.4 - 4.1
Pressure (PSI)	20 - 80	20 - 140	20 - 60
Speed settings	3	5	5
Spray distance (m)	5.2	7.3	-
Tank capacity (l)	3.7	15	15
Weight with battery pack (EPTA) (kg)	3.5 (M12 B6)	8.6 (M18 HB3)	8.3 (M18 HB3)
Available versions			
-0	✓	✓	✓
-201	✓	✗	✗

PRUNING SHEARS

See index page 149



SCAN HERE FOR MORE INFORMATION AND/ OR SEE PAGE 103 FOR RELATED SYSTEM ATTACHMENTS



	M18 BLTS	M12 BLPRS
Platform	M18™	M12™
Technology	Brushless	Brushless
Blade material	DC53	SK5 Steel
Length (m)	2.1 - 3.0	0.37
Max. cutting capacity (full) (mm)	44	32
Max. cutting capacity (half) (mm)	-	16
Mode select	No	Yes
Telescopic	Yes	No
Trigger tracking	No	Yes
Weight with battery pack (EPTA) (kg)	6.4 (M18 HB5.5)	1.5 (M12 B2)
Available versions		
-0	✓	✓
-202	✗	✓
-551	✓	✗

SNOW THROWER

See index page 153



SCAN HERE FOR MORE INFORMATION



	M18 F2SSBL
Platform	M18 FUEL™
Clearing depth (cm)	30.5
Clearing width (cm)	53.3
Speed settings	1
Throwing distance (m)	10.7
Weight with battery pack (EPTA) (kg)	42.6 (2 x M18 FB12)
Available versions	
-0	✓
-122	✓

OTHER M18 FOPH2 ATTACHMENTS

See index page 143



SCAN HERE FOR MORE INFORMATION AND/ OR SEE PAGE 103 FOR RELATED SYSTEM ATTACHMENTS



	M18 FOPH-BBA	M18 FOPH-RBA	M18 FOPH-CA	M18 FOPH-EXA
Platform	M18™	M18™	M18™	M18 FUEL™
Technology	QUIK-LOK™	QUIK-LOK™	QUIK-LOK™	QUIK-LOK™
Cleaning width [cm]	58	58	-	-
Diameter (mm)	254	267	230	-
Length (cm)	122	122	105	103
No load speed gear 1 (rpm)	0 - 150	0 - 150	0 - 150	-
No load speed gear 2 (rpm)	0 - 177	0 - 177	0 - 177	-
No load speed gear 3 (rpm)	0 - 205	0 - 205	0 - 205	-
Weight without battery pack (kg)	6.5	7.3	4.3	0.9
Available versions				
-0	✓	✓	✓	✓

RUN TIME DATA

APPLICATION	PRODUCT NAME	BATTERY	M18 FB6	M18 FB8	M18 FB12
CHAINSAWS					
LOG CUTTING CUTS IN 38 CM HARDWOOD	M18 F2CHS50 (WITH 2 X M18™ BATTERIES)	OPTIMISED FOR FORGE™	19 cuts	25 cuts	37 cuts
BRUSH CUTTERS					
TRIMMING - HIGH MODE <i>*MEASURED UNDER NO LOAD SPEED, SIMULATES LIGHT GRASS TRIMMING APPLICATION</i>	M18 F2BCU (WITH 2 X M18™ BATTERIES)	OPTIMISED FOR FORGE™	51 min	68 min	102 min
SNOW THROWERS					
SNOW REMOVAL 15 CM SNOW DEPTH	M18 F2SSBL (4 X M18 BATTERIES)	OPTIMISED FOR FORGE™	150 m²	200 m²	300 m²

		M18 HB3	M18 B4	M18 B5	M18 HB5.5	M18 FB8	M18 FB12
CHAINSAWS							
LOG CUTTING CUTS IN 10 CM CEDAR	M18 FCHSC	38 cuts	50 cuts	63 cuts	75 cuts	100 cuts	150 cuts
	M18 FCHS35	38 cuts	50 cuts	63 cuts	75 cuts	100 cuts	150 cuts
	M18 FCHS	38 cuts	50 cuts	63 cuts	75 cuts	100 cuts	150 cuts
TOP HANDLE CHAINSAWS							
LOG CUTTING CUTS IN 10 CM CEDAR	M18 FTHCHS30	56 cuts	75 cuts	93 cuts	112 cuts	150 cuts	225 cuts
	M18 FTHCHS35	56 cuts	75 cuts	93 cuts	112 cuts	150 cuts	225 cuts
PRUNING SAWS							
LOG CUTTING CUTS IN 10 CM CEDAR	M18 FHS20	90 cuts	120 cuts	150 cuts	180 cuts	240 cuts	360 cuts
POLE SAWS							
LOG CUTTING CUTS IN 15 CM CEDAR	M18 FTPS30	19 cuts	25 cuts	31 cuts	38 cuts	50 cuts	75 cuts
PRUNING CUTS IN 7.5CM OAK RODS ON SPEED LEVEL 3	M18 FOPH-CSA	56 cuts	75 cuts	94 cuts	113 cuts	150 cuts	225 cuts
BRUSH CUTTERS							
TRIMMING - HIGH MODE <i>*MEASURED UNDER NO LOAD SPEED, SIMULATES LIGHT GRASS TRIMMING APPLICATION</i>	M18 FBCU	12 min	13 min	16 min	24 min	33 min	49 min
TRIMMING - LOW MODE <i>*MEASURED UNDER NO LOAD SPEED, SIMULATES LIGHT GRASS TRIMMING APPLICATION</i>		22 min	23 min	29 min	44 min	58 min	88 min
TRIMMING - HIGH MODE <i>LIGHT LOAD RUN-TIME WITH THE BLADE AT FULL THROTTLE ON SPEED LEVEL 3</i>	M18 FOPH-BCA	11 min	15 min	19 min	23 min	30 min	45 min
GRASS TRIMMERS							
TRIMMING - HIGH MODE <i>MEASURED UNDER CONSTANT LIGHT GRASS TRIMMING APPLICATION</i>	M18 BLLT	13 min	17 min	22 min	26 min	35 min	53 min
	M18 FOPH-LTA	11 min	15 min	19 min	23 min	30 min	45 min
	M18 FOPH-RA	11 min	15 min	18 min	22 min	30 min	45 min
HEDGE TRIMMERS							
NO LOAD RUN-TIME AT FULL THROTTLE <i>DETAILED SHAPING: UP TO 6 MM BRANCHES</i>	M18 FHET75G2	21 min	28 min	34 min	41 min	55 min	80 min
	M18 FHET60G2	22 min	30 min	37 min	45 min	60 min	90 min
POLE HEDGE TRIMMERS							
NO LOAD RUN-TIME AT FULL THROTTLE <i>DETAILED SHAPING: UP TO 6 MM BRANCHES</i>	M18 FHETSP	30 min	40 min	50 min	60 min	80 min	120 min
	M18 FHETE22 / M18 FHETE27	19 min	25 min	31 min	38 min	50 min	75 min
TRIMMING - HIGH MODE <i>NO LOAD RUNTIME ON SPEED LEVEL 3 (SIMULATES LIGHT TRIMMING APPLICATION)</i>	M18 FOPH-HTA	34 min	45 min	56 min	68 min	90 min	135 min
	M18 FOPH-SHTA	34 min	45 min	56 min	68 min	90 min	135 min
SECATEURS							
BRANCH CUTTING CUTS IN 2.5 CM SOFTWOOD	M18 BLTS	1000 cuts	1300 cuts	1650 cuts	2000 cuts	2600 cuts	3900 cuts

SAWING AND CUTTING

TRIMMING AND CLEARING

*Charge times are based on a fully-charged battery. These given guidelines are indicative only and may not be replicated due to the varying usage conditions. Results can vary depending on the user and the application.

RUN TIME DATA

APPLICATION	PRODUCT NAME	BATTERY	M18 HB3	M18 B4	M18 B5	M18 HB5.5	M18 FB8	M18 FB12
LAWN MOWERS								
GRASS CUTTING <i>*REMOVING 2.5 CM OF GRASS AT 4.8 KM/H</i>	M18 F2LM53 (WITH 2 X M18™ BATTERIES)	OPTIMISED FOR FORGE™	1000 m²	1300 m²	2000 m²			
	M18 F2LM46 (WITH 2 X M18™ BATTERIES)		1200 m²	1600 m²	2400 m²			
LEAF BLOWERS								
TOUGH BLOWING - HIGH MODE	M18 F2BPB (WITH 4 X M18™ BATTERIES)	OPTIMISED FOR FORGE™	15 min	20 min	30 min			
MID BLOWING - MID MODE			22 min	30 min	45 min			
LOW BLOWING - LOW MODE			30 min	40 min	60 min			
TOUGH BLOWING - HIGH MODE	M18 F2BL (WITH 2 X M18™ BATTERIES)	OPTIMISED FOR FORGE™	13 min	18 min	26 min			
MID BLOWING - MID MODE			33 min	45 min	65 min			
TOUGH BLOWING - HIGH MODE	M18 BLBLO	6 min	8 min	10 min	12 min	16 min	24 min	
	M18 FBLLG3	5 min	6 min	8 min	10 min	12 min	19 min	
	M18 FOPH-BA	5 min	7 min	9 min	11 min	14 min	21 min	
CULTIVATORS								
CULTIVATE - HIGH MODE <i>MEASURED UNDER LOAD IN A STANDARD CULTIVATING APPLICATION</i>	M18 FOPH-CA	9 min	12 min	15 min	18 min	24 min	36 min	
EDGERS								
EDGING <i>*MEASURED UNDER LOAD AT FULL SPEED AND FULL DEPTH INTO SOFT SOIL</i>	M18 FEDG	7 min	10 min	12 min	15 min	20 min	31 min	
NO LOAD RUN-TIME AT FULL THROTTLE <i>(SIMULATES LIGHT EDGING APPLICATION)</i> <i>*MEASURED UNDER LOAD AT FULL SPEED AND FULL DEPTH INTO SOFT SOIL</i>	M18 FOPH-EA	8 min	10 min	13 min	15 min	21 min	31 min	
CLEANING								
HIGH MODE <i>LIGHT DEBRIS CLEANING</i>	M18 FOPH-BBA	10 min	13 min	16 min	20 min	26 min	39 min	
	M18 FOPH-RBA	10 min	13 min	16 min	20 min	26 min	39 min	
SWITCH TANK™								
SPRAYING <i>*NUMBER OF TANKS ON MODE 3</i>	M18 BBPFP2	12 tanks	27 tanks	34 tanks	41 tanks	54 tanks	81 tanks	

LAWN MOWING

SOIL, TURF & GROUNDS CARE

SPRAYERS

		M12 B2	M12 B3	M12 B4	M12 B6	M12 HB2.5	M12 HB5
PRUNING SAWS							
LOG CUTTING CUTS IN 5 CM OAK	M12 FHS	60 cuts	90 cuts	120 cuts	180 cuts	86 cuts	172 cuts
HEDGE TRIMMERS							
LIGHT TRIMMING <i>*NO LOAD RUN TIME AT FULL THROTTLE (SIMULATES LIGHT TRIMMING APPLICATION)</i>	M12 FHT20	17 min	26 min	35 min	50 min	25 min	48 min
HANDHELD SPRAYERS							
SPRAYING <i>*FIRST MODE - SPOT SPRAYING</i>	M12 BHCS3L	300 litres	450 litres	600 litres	900 litres	431 litres	862 litres
SECATEURS							
BRANCH CUTTING CUTS IN 1,25 CM SOFTWOOD	M12 BLPRS	1000 cuts	1500 cuts	2000 cuts	3000 cuts	1400 cuts	2800 cuts

SCAN TO VIEW OUR OPE RANGE



POWER SUPPLIES



SCAN HERE FOR MORE INFORMATION



See index page 148

	MXF PS	IRPSUOP2500	IRPSUOP6000
Platform	MX FUEL™	-	-
ONE-KEY™	ONE-KEY™	ONE-KEY™	ONE-KEY™
AC Ports	2	3	3
Charging time (min)	-	180	480
Energy content (Wh)	864	2,500	6,000
Running power (W)	1,800	3,600	3,600
Starting power (W)	3,600	7,200	7,200
Weight (kg)	28.2 (2 x MXF XC406)	47.0	82.24
Available versions			
-0	✓	✗	✗
-602	✓	✗	✗
- Internal rechargeable	✗	✓	✓

TOWER LIGHTS



SCAN HERE FOR MORE INFORMATION



See index pages 146 - 148

	MXF TL	MXF TLIC	M18 ONERSAL	M18 HOSALC	M18 SAL2	M12 SAL
Platform	MX FUEL™	MX FUEL™	M18™	M18™	M18™	M12™
Technology	TRUEVIEW™	TRUEVIEW™	TRUEVIEW™	TRUEVIEW™	TRUEVIEW™	TRUEVIEW™
ONE-KEY™	ONE-KEY™	ONE-KEY™	ONE-KEY™	-	-	-
Carry handle	Yes	Yes	Yes	Yes	Yes	Yes
CCT (Correlated Colour Temperature)(K)	4,000	4,000	4,000	4,000	4,000	4,000
Charging function	Yes	Yes	No	Yes	No	No
IP protection class	55	56	67	34	54	20
Max. height (m)	3.1	2.13	1.65	2.2	2.2	1.72
Max. lumens	27,000	15,000	5,400	6,000	2,800	1,400
Max. run time high / medium / low (h)	3/ 6/ 10	3/ 6/ 10	7/ 12.5/ 26	3.5/ 5/ 10	4.5/ 8.5/ 13.5	4/ -/ 10
Power source	AC, DC	AC, DC	DC	AC, DC	DC	DC
Weight with battery pack (EPTA) (kg)	53 (MXF XC406)	21.8 (MXF XC406)	10.1 (M18 B5)	11 (M18 HB8)	7.6 (M18 B5)	3.4 (M12 B4)
Available versions						
-0	✓	✓	✓	✓	✓	✓
-502B	✗	✗	✗	✗	✓	✗
-601	✓	✓	✗	✗	✗	✗

TRUEVIEW™

1 TRUEST COLOUR ACCURACY



- True representation of colours and details
- Neutral white light for greatest clarity and comfort
- Designed to represent sunlight at 10 am or 2 pm

SCAN HERE FOR MORE INFORMATION



2 BEST-IN-CLASS BEAM PATTERN OPTICS

- Even and consistent beam pattern from edge to edge
- Accurate and efficient work environment, no hot spots or washed-out borders
- Reflectors and diffusers optimised for each light

3 REDLITHIUM™ BATTERY TECHNOLOGY

- Portable solutions
- Long lasting reliability
- System compatibility



SITE LIGHTS



SCAN HERE FOR MORE INFORMATION



See index pages 146 - 148

	M18 ONESLSP	M18 ONESLDP
Platform	M18™	M18™
Technology	TRUEVIEW™	TRUEVIEW™
ONE-KEY™	ONE-KEY™	ONE-KEY™
Carry handle	Yes	Yes
CCT (Correlated Colour Temperature)(K)	4,000	4,000
CRI [Colour Rating Index]	70	80
Charging function	No	Yes
IP protection class	54	54
Max. lumens	4,400	9,000
Max. run time high / medium / low (h)	2/ 4/ 8	3.5/ 7/ 14
Power source	AC, DC	AC, DC
Weight with battery pack (EPTA) (kg)	6.7 (M18 B5)	12.5 (M18 B9)
Available versions		
-0	✓	✓

PORTABLE LIGHTS

See index pages 146 - 148



SCAN HERE FOR MORE INFORMATION



	M18 MDTL-0	M18 URSL-0	M18 HOAL-0	M18 POALC-0	M18 ABL-0	M18 PAL2-0		M18 TAL-0	M18 AL-0	M12 POAL-0	M12 UHL-0	M12 ALIP-0	M12 UCL-0	M18 ALIS-0
Platform	M18™	M18™	M18™	M18™	M18™	M18™		M18™	M18™	M12™	M12™	M12™	M12™	M18™
Technology	TRUEVIEW™	TRUEVIEW™	TRUEVIEW™	TRUEVIEW™	TRUEVIEW™	TRUEVIEW™		TRUEVIEW™	TRUEVIEW™	TRUEVIEW™	TRUEVIEW™	TRUEVIEW™	TRUEVIEW™	TRUEVIEW™
Compatible with	-	-	-	PACKOUT™	-	-		-	-	PACKOUT™	-	PACKOUT™	-	-
ONE-KEY™	-	ONE-KEY™	-	-	-	-		-	-	-	-	-	-	-
Carry handle	Yes	Yes	Yes	Yes	Yes	Yes		Yes	Yes	Yes	Yes	Yes	Yes	Yes
CRI [Colour Rating Index]	80	80	80	80	80	80		80	80	80	80	80	80	80
CCT (Correlated Colour Temperature)(K)	4,000	4,000	4,000	4,000	4,000	4,000		4,000	4,000	4,000	4,000	4,000	4,000	4,000
IP protection class	20	54	20	54	54	20		20	20	54	IP54	54	20	20
Mounting	Magnetic base, Integrated hook, Screw holes	Magnetic base	Screw holes, Handle	PACKOUT™	Magnetic base	Magnetic base, Clamp		Integrated hook	Handle	PACKOUT™	Integrated hook	Integrated hook, Magnetic base, PACKOUT™	Magnetic base	Integrated hook
Magnetic	No	Yes	No	No	Yes	Yes		No	No	No	No	No	No	No
Charging function	No	No	No	Yes	No	No		No	No	No	No	No	No	No
Max. lumens	4,500	4,250	4,000	3,000	2,500	2,000		2,200	1,500	1,400	1,350	1,200	1,200	1,000
Max. run time high / medium / low (h)	3/ 6/ 11	3.5/ 3.5/ 12	3/ 6/ 12	4/ 8/ 12	4.5/ 8/ 12	6/ 12/ 24		6/ 12/ 24	3/ -/ 6	4/ 7/ 12	4/ -/ 8	4/ 8/ 16	5/ 8/ 15	12/ 22/ 42/ 110
Power source	AC, DC	DC	AC, DC	AC, DC	DC	DC		DC	DC	DC	DC	DC	DC	DC
Weight with battery pack (EPTA) (kg)	3.75 (M18 B5)	7.38 (M18 HB12)	3.3 (M18 B5)	5.9 (M18 B5)	4.4 (M18 B5)	2.9 (M18 B5)		2.5 (M18 B5)	2.1 (M18 B5)	2.5 (M12 B2)	1.1 (M12 B4)	0.8 (M12 B2)	1.7 (M12 B4)	1.2 (M18 B5)
Available versions														
-0	✓	✓	✓	✓	✓	✓		✓	✓	✓	✓	✓	✓	✓



	M12 AL	M12 CML	M18 LL	M12 PAL	L4 FFL	L4 SL		IR FFL	L4 PWL	L4 FL	M12 LL	L4 HSL	M18 IL	FL-LED
Platform	M12™	M12™	M18™	M12™	REDLITHIUM™ USB	REDLITHIUM™ USB		Rechargeable	REDLITHIUM™ USB	REDLITHIUM™ USB	M12™	REDLITHIUM™ USB	M18™	2 x AA Alkaline Batteries
Technology	TRUEVIEW™	TRUEVIEW™	TRUEVIEW™	TRUEVIEW™	TRUEVIEW™	TRUEVIEW™		TRUEVIEW™	TRUEVIEW™	TRUEVIEW™	TRUEVIEW™	TRUEVIEW™	TRUEVIEW™	TRUEVIEW™
Carry handle	Yes	No	Yes	No	Yes	No		Yes	No	No	Yes	No	Yes	No
CRI [Colour Rating Index]	80	98	-	80	80	80		80	80	80	-	80	80	80
CCT (Correlated Colour Temperature)(K)	4,000	2,700 - 6,500	-	4,000	4,000	4,000		4,000	4,000	4,000	-	4,000	4,000	4,000
IP protection class	54	54	24	54	54	52		54	54	54	24	54	54	54
Mounting	Magnetic base, Clamp, Screw holes	Magnetic base	Integrated hook	Magnetic base	Carabiner, Magnetic base	Integrated hook, Magnetic base		Carabiner, Magnetic base	Magnetic base	Magnetic base	Integrated hook	-	Integrated hook	Magnetic base
Magnetic	Yes	Yes	No	Yes	Yes	Yes		Yes	Yes	Yes	No	No	No	Yes
Charging function	No	No	No	No	Yes	Yes		Yes	Yes	Yes	No	Yes	No	No
Max. lumens	1,000	1,000	700	700	550	550		500	500	445	400	350	300	300
Max. run time high / medium / low (h)	3.5/ 7.5/ 15	6/ 8/ 14	10/ 20/ 100/ 16	8/ 24/ -	2/ 4.5/ 11.5	2/ 4.5/ 5		4/ 8/ 12	3/ 10/ 3	2/ -/ 11	8/ 15/ 67	2/ -/ 10	17/ -/ 34	5/ -/ 16
Power source	DC	DC	DC	DC	DC	DC		DC	DC	DC	DC	DC	DC	DC
Weight with battery pack (EPTA) (kg)	1.6 (M12 B6)	0.73 (M12 B4)	0.96 (M18 B2)	0.9 (M12 B4)	0.20 (L4 B3)	0.30 (L4 B3)		0.28 (internal battery)	0.20 (L4 B3)	0.20 (L4 B3)	0.64 (M12 B2)	0.240 (L4 B3)	1.2 (M18 B5)	0.10 (2 x AA)
Available versions														
-0	✓	✗	✓	✓	✗	✗		✗	✗	✗	✓	✗	✓	✗
-301	✗	✗	✗	✗	✓	✓		✗	✓	✓	✗	✓	✗	✗
-401	✗	✓	✗	✗	✗	✗		✗	✗	✗	✗	✗	✗	✗
- Internal rechargeable	✗	✗	✗	✗	✗	✗		✓	✗	✗	✗	✗	✗	✗
Alkaline	✗	✗	✗	✗	✗	✗		✗	✗	✗	✗	✗	✗	✓

TORCHES



SCAN HERE FOR MORE INFORMATION



See index pages 146 - 148

	L4 FL2000	M18 SLED	L4 TMLLED	L4 FMLED	M12 SLED		IR FL	ML-LED	IR PL	M12 SL	M18 TLED	M12 TLED	IPL-LED
Platform	REDLITHIUM™ USB	M18™	REDLITHIUM™ USB	REDLITHIUM™ USB	M12™		Rechargeable	3 x AAA Alkaline Batteries	Rechargeable	M12™	M18™	M12™	2 x AAA Alkaline Batteries
Technology	TRUEVIEW™	TRUEVIEW™	TRUEVIEW™	TRUEVIEW™	TRUEVIEW™		TRUEVIEW™	TRUEVIEW™	TRUEVIEW™	TRUEVIEW™	TRUEVIEW™	TRUEVIEW™	TRUEVIEW™
Max. beam distance (m)	200	640	150	150	550		100	-	70	-	-	-	28
IP protection class	66	54	67	67	24		67	67	67	20	20	20	67
Max. lumens	2,000	1,250	1,100	800	750		500	325	250	220	120	120	100
Max. run time high / medium / low (h)	4/ 8/ 24	4/ 5/ 7	1/ 4/ 10	2/ -/ 10	4/ -/ 8		3.5/ 16/ 40	5/ -/ 18	1.5/ -/ 8	11/ -/ -	29/ -/ -	15/ -/ -	3/ -/ -
Weight with battery pack (EPTA) (kg)	0.264 (L4 B3)	2.2 (M18 B5)	0.20 (L4 B3)	0.20 (L4 B3)	1.2 (M12 B4)		0.10 (internal battery)	0.10 (3 x AAA)	0.06 (w/ internal battery)	0.63 (M12 B4)	0.70 (M18 B2)	0.50 (M12 B2)	0.10 (2 x AAA)
Available versions													
-0	x	✓	x	x	✓		x	x	x	✓	✓	✓	x
-301	✓	x	✓	✓	x		x	x	x	x	x	x	x
- Internal rechargeable	x	x	x	x	x		✓	x	✓	x	x	x	x
Alkaline	x	x	x	x	x		x	✓	x	x	x	x	✓

HEAD TORCHES



SCAN HERE FOR MORE INFORMATION



See index pages 146 - 148

	L4 HL2	L4 HL-VIS	L4 HLRP	L4 BOLTHL		IR HL	HL-SF	L4 NL400	HL2-LED	ISHL-LED
Platform	REDLITHIUM™ USB	REDLITHIUM™ USB	REDLITHIUM™ USB	REDLITHIUM™ USB		Rechargeable	3 x AAA Alkaline Batteries	REDLITHIUM™ USB	3 x AAA Alkaline Batteries	3 x AAA Alkaline Batteries
Technology	TRUEVIEW™	TRUEVIEW™	TRUEVIEW™	TRUEVIEW™		TRUEVIEW™	TRUEVIEW™	TRUEVIEW™	TRUEVIEW™	TRUEVIEW™
Max. beam distance (m)	120	125	-	-		50	92	38	-	100
IP protection class	54	53	54	54		54	52	50	52	64
Max. lumens	600	600	600	600		450	450	400	350	310
Max. run time high / medium / low (h)	5/ 9/ 20	2/ 4/ 8/ 20	2/ 6/ 10/ 25	4/ 8/ 14/ 32		4/ 14	2/ 4/ 10	2.5/ 8	4/ 8.5/ 28	4/ 6/ 8/ 10/ 40
Weight with battery pack (EPTA) (kg)	0.20 (L4 B3)	0.20 (L4 B3)	0.20 (L4 B3)	0.24 (L4 B3)		0.12 (w/ internal battery)	0.10 (3 x AAA)	0.23 (L4 B3)	0.10 (3 x AAA)	0.10 (3 x AAA)
Available versions										
-301	✓	✓	✓	✓		x	x	✓	x	x
- Internal rechargeable	x	x	x	x		✓	x	x	x	x
Alkaline	x	x	x	x		x	✓	x	✓	✓

ZERO EMISSIONS IN USE.* ZERO COMPROMISE.

ENSURING OUR USERS CAN WORK SAFELY,
SUSTAINABLY, AND PRODUCTIVELY.

THE EU AIMS TO BE
CLIMATE-NEUTRAL
BY 2050**

ONE SYSTEM, OVER 30 TOOLS

- PETROL EQUIVALENT PERFORMANCE**
- LOW NOISE**
- NO PETROL OR EMISSIONS**
- LESS DOWNTIME**
- ENHANCED JOBSITE SAFETY**
- INCREASED PRODUCTIVITY**

*Zero emissions when product in use

** Information sourced from European commission press release, available: Making the EU climate-neutral by 2050 (europa.eu)



ZERO
EMISSIONS IN USE

REDLITHIUM™ FORGE™

MOST POWER | FASTEST CHARGING | LONGEST LIFE*

**UP TO MORE
2X RUN TIME**
SIMILAR SIZE AND WEIGHT VS. XC406



**COOL-CYCLE™
CAPABLE**
HIGH SPEED COOLING



COOL-CYCLE™
ACTIVE COOLING SYSTEM

**LONGEST
LIFE**
VS REDLITHIUM™



* Vs other cell technologies



EQUIPMENT REDEFINED. TRADE FOCUSED. SYSTEM WIDE.

THE MILWAUKEE® MX FUEL™ CORDLESS SYSTEM REVOLUTIONISES THE LIGHT EQUIPMENT MARKET BY DELIVERING THE PERFORMANCE, RUN TIME, AND DURABILITY DEMANDED BY THE TRADES WITHOUT THE HAZARDS ASSOCIATED WITH EMISSIONS, NOISE, VIBRATION, AND THE FRUSTRATIONS OF PETROL MAINTENANCE.

NOW WITH OVER 25 SOLUTIONS, THE MX FUEL™ EQUIPMENT SYSTEM PROVIDES EQUIVALENT PETROL, CORDED AND PNEUMATIC PERFORMANCE WHILE PRODUCING ZERO EMISSIONS IN USE.

TOOL	APPLICATION	BATTERY	
		MXF XC608	MXF HD812
MXF COS350G2	Cutting kerbstone	36 cuts*	50 cuts*
MXF DH2528H	Breaking concrete	1.3 tonnes*	4 tonnes*
MXF DCD150	76 mm x 250 mm holes	17 holes*	26 holes*
MXF DCD350	250 mm x 150 mm holes	3 holes*	5 holes*
MXF PS	Grinding with 180 mm corded angle grinder	40 min*†	60 min*†
MXF CVHF	Pouring concrete	55 m³*	82 m³*
MXF CVBP	Pouring concrete	53 m³*	80 m³*
MXF CVBC	Pouring concrete	53 m³*	80 m³*
MXF PSC	Screeding concrete	5 hours 20 min*	8 hours*
MXF WBT60	Finishing concrete	23 min*	35 min*
MXF WBT90	Finishing concrete	16 min*	25 min*
MXF PC50	Compacting gravel	22 min*	35 min*
MXF RAM	Compacting gravel	17 min*	25 min*
MXF SMP2	Pumping water (High Mode)	28 min*	40 min*
MXF PTR2	Full cycle	200 cycles*	280 cycles*
MXF TL	on High Mode	4 hours*	6 hours*
MXF TLIC	on High Mode	4 hours*	6 hours*

* Run times are based on a fully-charged battery. These given guidelines are indicative only and may not be replicated due to the varying usage conditions. Results can vary depending on the user and the application.

† Using 2 batteries during application.

COMPARE OUR CHARGERS

	MXF HD812	MXF XC608	MXF XC406	MXF CP203
MXF SC	65 min	45 min	45 min	45 min
NEW MXF FC	100 min	65 min	45 min	45 min
MXF C	160 min	110 min	90 min	45 min

UPGRADE YOUR TOOLS WITH FORGE™

SCAN HERE TO VIEW OUR FULL RANGE OF FORGE BATTERIES



HD REDLITHIUM™
HIGH OUTPUT BATTERY TECHNOLOGY

VS

M18 REDLITHIUM FORGE™
MOST POWER | FASTEST CHARGING | LONGEST LIFE*



BATTERY RUN TIMES

TOOL DESCRIPTION	APPLICATION	HD REDLITHIUM™ BATTERY TECHNOLOGY		M18 REDLITHIUM FORGE™		RESULTS PER BATTERY CHARGE
		M18 HB8	M18 HB12	M18 FB8	M18 FB12	
M18 FCHS M18 FUEL™ CHAINSAW WITH 40 CM BAR	LOG CUTTING CUTTING OF 30 CM SPRUCE TREE		23 cuts*		36 cuts*	up to 56% increase*
M18 F2CHS50 M18 FUEL™ 50 CM DUAL BATTERY CHAINSAW	LOG CUTTING CUTTING OF 35 CM SPRUCE TREE	23 cuts**		32 cuts**		up to 39% increase*
M18 FTHCHS35 M18 FUEL™ TOP HANDLE CHAINSAW WITH 35 CM BAR	LOG CUTTING CUTTING OF 30 CM SPRUCE TREE	12 cuts*		24 cuts*		up to 100% increase*
M18 FLAG230XPDB M18 FUEL™ 230 MM LARGE BRAKING GRINDER WITH PADDLE SWITCH	METAL GRINDING MATERIAL REMOVAL FROM STEAM BEAM		147 g debris removal*		234 g debris removal*	up to 59% increase*
M18 ONEFLAG230XPDB M18 FUEL™ ONE-KEY™ 230 MM BRAKING ANGLE GRINDER WITH PADDLE SWITCH	METAL GRINDING MATERIAL REMOVAL FROM STEAM BEAM		187 g debris removal*		223 g debris removal*	up to 19% increase*
M18 FHSAG125XPDB M18 FUEL™ HIGH PERFORMANCE 125 MM BRAKING GRINDER WITH PADDLE SWITCH	PIPE CUTTING CUTTING OF 22 MM METAL PIPES		127 cuts*		175 cuts*	up to 38% increase*
M18 FMCS66 M18 FUEL™ 66 MM METAL CIRCULAR SAW	METAL CUTTING CUTTING OF 3 MM SHEET METAL		22 metre cuts*		25 metre cuts*	up to 15% increase*
M18 FCS66GR3 M18 FUEL™ GUIDE RAIN COMPATIBLE CIRCULAR SAW	LAMINATED CUTTING RIP CUT THROUGH 42 MM LAMINATED PINE 140 MM CUTS		28 cuts*		34 cuts*	up to 22% increase*
M18 FCS230 M18 FUEL™ CUT-OFF SAW	KERBSTONE CUTTING CUTTING OF 250 X 80 MM KERBSTONE		7 cuts*		11 cuts*	up to 46% increase*

*Runtimes are based on a fully-charged battery. These given guidelines are indicative only and may not be replicated due to the varying usage conditions. Results can vary depending on the user and the application. † Using 2 batteries.

NEW M18 REDLITHIUM™ FORGE™

MOST POWER | FASTEST CHARGING | LONGEST LIFE

WHAT MAKES REDLITHIUM™ FORGE™?



NEW LITHIUM CELL TECHNOLOGIES	NEXT GENERATION ELECTRONICS	MECHANICAL REDESIGN	ADVANCED PROTECTION
<p>OLD TAB DESIGN</p> <p>NEW TABLESS DESIGN</p> <ul style="list-style-type: none"> ▶ Up to 50% higher power ▶ Up to 45% less heat generation ▶ Up to 6X faster charging ▶ Up to 50% lower electrical resistance 	<ul style="list-style-type: none"> ▶ Maximise full power delivery to tool ▶ Accelerate charge speed ▶ Full system backwards compatibility 	<ul style="list-style-type: none"> ▶ Advanced thermal management ▶ Vibration protection ▶ Built to withstand harsh jobsite environments ▶ Laser welding 	<ul style="list-style-type: none"> ▶ Patented polymer ingress coating: protection against water and debris ▶ Resistant housing: protection against common oils, greases and solvents

* Vs other cell technologies

ACTIVE COOLING SYSTEM

WORK DONE WITH 80% CHARGE

Up to 18.5 cuts of 400 mm hard wood with 2x M18 FB12 (M18 F2CHS50)

Up to 553 cuts in 50 x 100 mm soft wood with M18 FB12 (M18 FCS66)

TIME TO COOL & CHARGE A HOT BATTERY

Process	RedLithium Forge (Cool-Cycle)	HD RedLithium (Rapid Charger)
Charge to 80%	35min	45min
Cool off time	1.5min	20min
Charge to 100%	150min	-

THREE BENEFITS OF COOL-CYCLE™ ACTIVE COOLING SYSTEM

COOL-CYCLE™ CAPABLE PACKS:

- BEGIN CHARGING RAPIDLY
- COME OFF THE CHARGER COOLER, RESULTING IN MORE WORK DONE PER DAY
- HAVE LONGER LIFE

* vs previous generation

BATTERIES

See index pages 126 - 127



SCAN HERE FOR MORE INFORMATION



	MXF PBE	MXF HD812	MXF XC608	MXF XC406	MXF CP203	M18 FB12	M18 FB8	M18 FB6	M18 HB5.5	M18 HB3	M18 B5
Platform	MX FUEL™	MX FUEL™	MX FUEL™	MX FUEL™	MX FUEL™	M18™	M18™	M18™	M18™	M18™	M18™
Technology	-	FORGE™	FORGE™	-	-	FORGE™	FORGE™	FORGE™	HIGH OUTPUT™	HIGH OUTPUT™	-
Feature	-	COOL-CYCLE™	COOL-CYCLE™	-	-	COOL-CYCLE™	COOL-CYCLE™	-	-	-	-
ONE-KEY™	-	ONE-KEY™	ONE-KEY™	ONE-KEY™	-	-	-	-	-	-	-
Battery pack capacity (Ah)	-	12.0	8.0	6.0	3.0	12.0	8.0	6.0	5.5	3.0	5.0
Charge time M12-18 AC charger	-	-	-	-	-	285 min	190 min	130 min	130 min	75 min	100 min
Charge time M12-18 C charger	-	-	-	-	-	250 min	167 min	115 min	115 min	65 min	100 min
Charge time M12-18 FC charger	-	-	-	-	-	130 min	87 min	60 min	60 min	36 min	59 min
Charge time M12-18 SC charger	-	-	-	-	-	60 min	45 min	35 min	35 min	36 min	59 min
Charge time M1418C6 charger	-	-	-	-	-	270 min	190 min	125 min	125 min	70 min	100 min
Charge time M18 DBSC/MBSC AC charger	-	-	-	-	-	45 min	45 min	25 min	35 min	36 min	59 min
Charge time M18 DFC charger	-	-	-	-	-	130 min	87 min	60 min	60 min	36 min	59 min
Charge time M18 PC6/MPC6 AC charger	-	-	-	-	-	130 min	87 min	60 min	60 min	36 min	59 min
Charge time MXF C charger	-	160 min	110 min	90 min	45 min	-	-	-	-	-	-
Charge time MXF FC charger	-	100 min	65 min	45 min	45 min	-	-	-	-	-	-
Charge time MXF SC charger	-	65 min	45 min	45 min	45 min	-	-	-	-	-	-
Weight (kg)	11.5	5.9	4.5	4.8	2.7	1.51	1.08	1.03	1.1	0.7	0.7



	M18 B5-CR	M18 B4	M18 B2	M12 HB5	M12 HB2.5	M12 B6	M12 B4	M12 B3	M12 B2	L4 B3
Platform	M18™	M18™	M18™	M12™	M12™	M12™	M12™	M12™	M12™	REDLITHIUM™ USB
Technology	-	-	-	HIGH OUTPUT™	HIGH OUTPUT™	-	-	-	-	-
Battery pack capacity (Ah)	5.0	4.0	2.0	5.0	2.5	6.0	4.0	3.0	2.0	3.0
Charge time C12 C charger	-	-	-	110 min	55 min	130 min	80 min	70 min	40 min	-
Charge time M12 C4 charger	-	-	-	110 min	55 min	130 min	80 min	70 min	40 min	-
Charge time M12 TC2 charger	-	-	-	300 min	150 min	347 min	240 min	174 min	120 min	-
Charge time M12-18 AC charger	100 min	80 min	40 min	110 min	55 min	165 min	115 min	90 min	55 min	-
Charge time M12-18 C charger	100 min	80 min	40 min	110 min	55 min	130 min	80 min	70 min	40 min	-
Charge time M12-18 FC charger	59 min	52 min	26 min	75 min	40 min	95 min	52 min	50 min	26 min	-
Charge time M12-18 SC charger	59 min	52 min	26 min	75 min	40 min	95 min	52 min	50 min	26 min	-
Charge time M1418C6 charger	100 min	80 min	40 min	-	-	-	-	-	-	-
Charge time M18 DBSC/MBSC AC charger	59 min	52 min	26 min	-	-	-	-	-	-	-
Charge time M18 DFC charger	59 min	52 min	26 min	-	-	-	-	-	-	-
Charge time M18 PC6/MPC6 AC charger	59 min	52 min	26 min	-	-	-	-	-	-	-
Charge time L4 C charger	-	-	-	-	-	-	-	-	-	120 min
Weight (kg)	0.7	0.7	0.4	0.42	0.2	0.4	0.4	0.2	0.2	0.04

CHARGERS

See index pages 129 - 130



SCAN HERE FOR MORE INFORMATION



	MXF SC	MXF FC	MXF C	M18 MPC6		M18 PC6	M18 MDBSC	M18 DBSC	M18 DFC	M18 TC
Platform	MX FUEL™	MX FUEL™	MX FUEL™	M18™		M18™	M18™	M18™	M18™	M18™
Feature	COOL-CYCLE™	COOL-CYCLE™	-	-		-	COOL-CYCLE™	COOL-CYCLE™	-	-
ONE-KEY™	ONE-KEY™	-	-	-		-	-	-	-	-
Charging ports	1 x MX FUEL™	1 x MX FUEL™	1 x MX FUEL™	6 x M18™		6 x M18™; 1 x USB	2 x M18™	2 x M18™	2 x M18™	1 x M18™
Charge type	Single	Single	Single	Simultaneous		Simultaneous	Simultaneous	Simultaneous	Simultaneous	Single
Power source	AC	AC	AC	AC		AC, USB	AC	AC	AC	AC, USB
Carry handle	✓	✓	✓	✓		✓	✗	✗	✗	✗
Wall mountable	✗	✓	✓	✓		✓	✓	✓	✓	✗
Weight (kg)	8.9	2.33	2.7	4.0		3.65	2.57	2.5	1.76	0.371



	M1418C6	M12-18 FC	M12-18 C	M12-18 AC		M12-18 GBC4	M12 C4	C12 C	M12 TC2
Platform	M18™	M12™ & M18™	M12™ & M18™	M12™ & M18™		M12™ & M18™	M12™	M12™	M12™
Charging ports	6 x M14™ or 6 x M18™	1 x M12™, 1 x M18™	1 x M12™, 1 x M18™	1 x M12™, 1 x M18™		2x M18™ & 2x M12™ or M18™ hybrid ports	4 x M12™	1 x M12™	1 x M12™
Charge type	Sequential	Sequential	Sequential	Sequential		Simultaneous	Sequential	Single	Single
Power source	AC	AC	AC	DC		AC	AC	AC	AC, USB
Carry handle	✓	✗	✓	✗		✗	✗	✗	✗
Wall mountable	✓	✓	✓	✓		✓	✓	✓	✗
Weight (kg)	1.92	0.8	0.92	0.9		3.175	1.44	1.13	0.21

NRG KITS

See index page 143



SCAN HERE FOR MORE INFORMATION



	MXF FORGENRG-122	MXF FORGENRG-802FC	MXF NRG-406		M18 FORGENRG-122DBSC	M18 FORGENRG-122	M18 FORGENRG-802DBSC	M18 FORGENRG-802
Platform	MX FUEL™	MX FUEL™	MX FUEL™		M18™	M18™	M18™	M18™
Technology	FORGE™	FORGE™	-		FORGE™	FORGE™	FORGE™	FORGE™
ONE-KEY™	ONE-KEY™	ONE-KEY™	ONE-KEY™		-	-	-	-



	M18 FORGENRG-602DBSC	M18 HNRG-552	M18 HNRG-302		M18 NRG-502	M18 NRGCR-502	M18 NRG-402	M18 NRG-202
Platform	M18™	M18™	M18™		M18™	M18™	M18™	M18™
Technology	FORGE™	HIGH OUTPUT™	HIGH OUTPUT™		-	-	-	-
ONE-KEY™	-	-	-		-	-	-	-



	M12 NRG-603	M12 NRG-602	M12 NRG-402	M12 NRG-303		M12 NRG-302	M12 NRG-202	M12 NRG-201	L4 PPS
Platform	M12™	M12™	M12™	M12™		M12™	M12™	M12™	REDLITHIUM™ USB

SYSTEM ATTACHMENTS

SYSTEM ATTACHMENTS - VIBRATORS

SYSTEM ATTACHMENTS - CONCRETE VIBRATOR WHIPS

	Description	Compatible with	Slabs MXF CVBP	Slabs MXF CVBC	Footings MXF CVBP	Footings MXF CVBC	Columns MXF CVBP	Columns MXF CVBC	Walls MXF CVBP	Walls MXF CVBC	Article Number	EAN Code
a.	MXF CVS-2 m Vibrator shaft 2 m	MXF CVBC, MXF CVBP	✓✓✓	✓	✓✓✓	✓	✗	✗	✗	✗	4932478611	4058546348045
b.	MXF CVS-3 m Vibrator shaft 3 m	MXF CVBC, MXF CVBP	✓✓✓	✓	✓✓✓	✓	✓	✓	✓	✓	4932479612	4058546374068
c.	MXF CVS-4 m Vibrator shaft 4 m	MXF CVBC, MXF CVBP	✓	✓✓	✓	✓✓	✓✓✓	✓✓✓	✓✓✓	✓✓✓	4932478610	4058546348038
d.	MXF CVS-6.4 m Vibrator shaft 6.4 m	MXF CVBC, MXF CVBP	✗	✓✓✓	✗	✓✓✓	✗	✓✓✓	✗	✓✓✓	4932479613	4058546374075

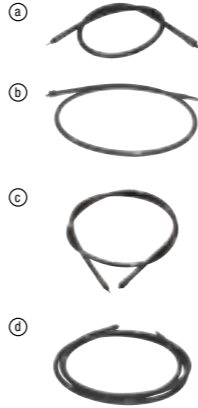

SYSTEM ATTACHMENTS - CONCRETE VIBRATOR HEADS

	Description	Diameter (mm)	Compatible with	Article Number	EAN Code
a.	MXF CVH-25 mm Vibrator head 25 mm	25	MXF CVBC, MXF CVBP	4932479839	4058546376338
b.	MXF CVH-38 mm Vibrator head 38 mm	38	MXF CVBC, MXF CVBP	4932478612	4058546348052
c.	MXF CVH-50 mm Vibrator head 50 mm	50	MXF CVBC, MXF CVBP	4932478613	4058546348069
d.	MXF CVH-63 mm Vibrator head 63 mm	63	MXF CVBC, MXF CVBP	4932479840	4058546376345

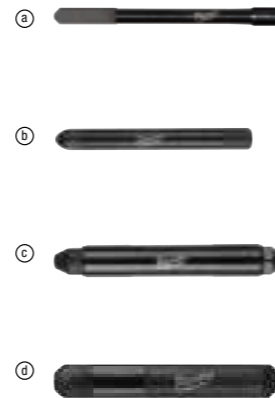

SYSTEM ATTACHMENTS - HIGH FREQUENCY CONCRETE VIBRATOR

	Description	Diameter (mm)	Length (m)	Compatible with	Article Number	EAN Code
a.	MXF CVSHF-2/44 Vibrator shaft 2 m/ 44 mm	44	2	MXF CVHF	4932498135	4058546512958
b.	MXF CVSHF-5/44 Vibrator shaft 5 m/ 44 mm	44	5	MXF CVHF	4932498136	4058546512965
c.	MXF CVSHF-10/44 Vibrator shaft 10 m/ 44 mm	44	10	MXF CVHF	4932498137	4058546512972
d.	MXF CVSHF-2/57 Vibrator shaft 2 m/ 57 mm	57	2	MXF CVHF	4932498917	4058546527860
e.	MXF CVSHF-5/57 Vibrator shaft 5 m/ 57 mm	57	5	MXF CVHF	4932498138	4058546512989
f.	MXF CVSHF-10/57 Vibrator shaft 10 m/ 57 mm	57	10	MXF CVHF	4932498139	4058546512996



SYSTEM ATTACHMENTS - PLATE COMPACTOR

	Description	Features	Article Number	EAN Code
a.	MXF PC50 PP Paver pad for MX FUEL™ plate compactor	<ul style="list-style-type: none"> Installation tool mounts directly onto the compactor for quick and easy access Dual direction compaction on bricks, pavers, and patio stones For use with the MX FUEL™ Plate Compactor (MXF PC50) 	4932493273	4058546481445
b.	MXF PC50 WK Wheel kit for MX FUEL™ plate compactor	<ul style="list-style-type: none"> Wheel kit for easy maneuverability For use with the MX FUEL™ Plate Compactor (MXF PC50) 	4932493274	4058546481452
c.	MXF PC50 WT Water tank for MX FUEL™ plate compactor	<ul style="list-style-type: none"> 13 litre water tank with quick-release attachment Adjustable flow rate dial for easy control and optimised water flow For use with the MX FUEL™ Plate Compactor (MXF PC50) 	4932498924	4058546527938

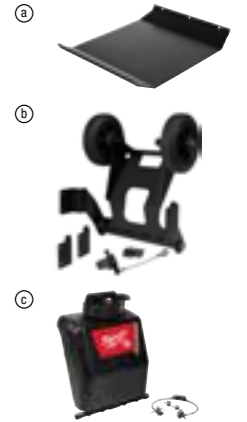

SYSTEM ATTACHMENTS - SCREED

	Description	Length (m)	Weight (kg)	Article Number	EAN Code
a.	MXF PSB-1.22m Screed blade for MX FUEL™ screed (MXF PSC) - 1.22 m	1.22	3.6	4932479776	4058546375706
b.	MXF PSB-1.83m Screed blade for MX FUEL™ screed (MXF PSC) - 1.83 m	1.83	5.5	4932479777	4058546375713
c.	MXF PSB-2.44m Screed blade for MX FUEL™ screed (MXF PSC) - 2.44 m	2.44	7.3	4932479778	4058546375720
d.	MXF PSB-3.00m Screed blade for MX FUEL™ screed (MXF PSC) - 3.0 m	3.00	9.1	4932479779	4058546375737
e.	MXF PSB-3.65m Screed blade for MX FUEL™ screed (MXF PSC) - 3.65 m	3.65	10.9	4932479780	4058546375744
f.	MXF PSB-4.25m Screed blade for MX FUEL™ screed (MXF PSC) - 4.25 m	4.25	12.8	4932479781	4058546375751
g.	MXF PSB-4.87m Screed blade for MX FUEL™ screed (MXF PSC) - 4.87 m	4.87	14.6	4932479782	4058546375768
h.	MXF PSCA MX FUEL™ screed bar adapter to L-shape	-	-	4932499258	4058546564223



SYSTEM ATTACHMENTS - TROWEL

	Description	Fits MILWAUKEE® trowel	Article Number	EAN Code
a.	MXF WBT60P Pan for MX FUEL™ 600 mm walk behind edging trowel	MXF WBT60	4932498919	4058546527884
b.	MXF WBT60CB 4 pc blade set for MX FUEL™ 600 mm walk behind edging trowel	MXF WBT60	4932498918	4058546527877
c.	MXF WBT90CB 4pc Combination blade set for MX FUEL™ 900 mm walk behind power trowel	MXF WBT90	4932498920	4058546527891
d.	MXF WBT90FIB 4 pc finish blade set for MX FUEL™ 900 mm walk behind power trowel	MXF WBT90	4932498923	4058546527921
e.	MXF WBT90FLB 4 pc float blades for MX FUEL™ 900 mm walk behind power trowel	MXF WBT90	4932498922	4058546527914

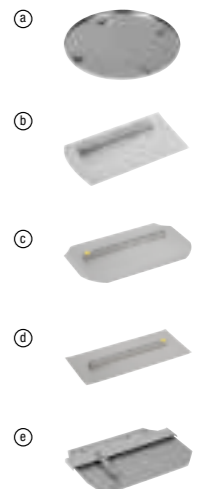

SYSTEM ATTACHMENTS - PIPE THREADER

	Description	Features	Article Number	EAN Code
a.	Reamer cone for MX FUEL™ pipe threading machine 2"	<ul style="list-style-type: none"> Replacement cone for the MX FUEL™ pipe threading machine 2" Durable metal construction Removes inner pipe burs Easy replacement process 	49165105	045242833634
b.	Pipe cutter wheel for MX FUEL™ pipe threading machine 2"	<ul style="list-style-type: none"> Black oxide coated For use in black iron pipe, rigid metal conduit, galvanized steel, and stainless steel 55Si2Mn steel One pack contains 4x cutter wheels 	48361401	045242745920
c.	Threading jaw inserts for PVC coated pipes	<ul style="list-style-type: none"> Standard threading jaws for steel pipes Special threading jaws for PVC coated pipes Jaw inserts are sold in packages of 6 for replacement of all inserts in the front and backside hammer chuck 	49165102	045242771288
d.	Threading jaw inserts for pipes	<ul style="list-style-type: none"> Standard threading jaws for steel pipes Special threading jaws for PVC coated pipes Jaw inserts are sold in packages of 6 for replacement of all inserts in the front and backside hammer chuck 	49165104	045242833627
e.	Pipe theader adapter kit for Ridgid 11-R	<ul style="list-style-type: none"> Adapter kit for M18 FPT2, pipe threader Small adapter for sizes 1/8" up to 1-1/4" Large adapter for 1-1/2" up to 2" 	4932478838	4058546361204
f.	Pipe theader adapter kit for REMS	<ul style="list-style-type: none"> Adapter kit for M18 FPT2, pipe threader Small adapter for sizes 1/8" up to 1-1/4" Large adapter for 1-1/2" up to 2" 	4932478839	4058546361211
g.	Pipe theader adapter kit for Rothenberger	<ul style="list-style-type: none"> Adapter kit for M18 FPT2, pipe threader Small adapter for sizes 1/8" up to 1-1/4" Large adapter for 1-1/2" up to 2" 	4932478840	4058546361228
h.	Pipe threader oil	<ul style="list-style-type: none"> 5l Canister of threading oil for use with the MX FUEL™ Pipe Threading Machine Ideal cooling performance ensuring high quality threads Mineral Based oil not for use on drink water lines 	4932493462	4058546483333
i.	Pipe threader oil	<ul style="list-style-type: none"> 5l Canister of threading oil for use with the MX FUEL™ Pipe Threading Machine Ideal cooling performance ensuring high quality threads Mineral Based oil not for use on drink water lines 	4932493463	4058546483340

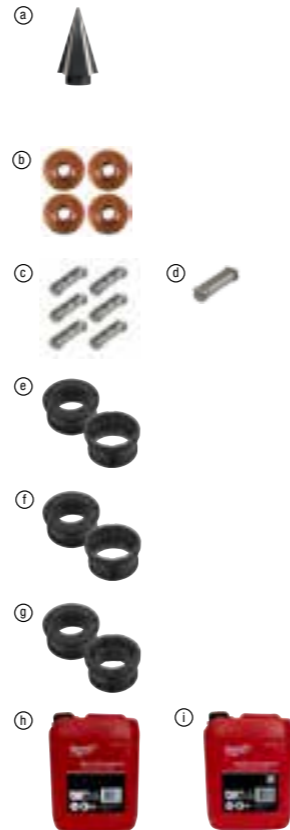

SYSTEM ATTACHMENTS - PIPE THREADER DIES

- Up to 50% lighter than competitive die heads
- Available sizes from 1/2" up to 2"
- Die heads always include a set of BSPT alloy dies

	Type	Thread size (inch)	Fits MILWAUKEE® pipe threader	Article Number	EAN Code
a.	FPTD 1/2" NPT HS	NPT HS	1/2	M18 FPT114, M18 FPT2	48361107 045242608713
	FPTD 3/4" NPT HS	NPT HS	3/4	M18 FPT114, M18 FPT2	48361108 045242608720
	FPTD 1" NPT HS	NPT HS	1	M18 FPT114, M18 FPT2	48361109 045242608737
	FPTD 1 1/4" NPT HS	NPT HS	1 - 1/4	M18 FPT114, M18 FPT2	48361110 045242608744
	FPTD 1 1/2" NPT HS	NPT HS	1 - 1/2	M18 FPT114, M18 FPT2	48361111 045242608751
b.	FPTD 2" NPT HS	NPT HS	2	M18 FPT114, M18 FPT2	48361112 045242608768
	FPTD 1/2" BSPT Alloy	BSPT Alloy	1/2	M18 FPT114, M18 FPT2	4932480227 4058546405120
	FPTD 3/4" BSPT Alloy	BSPT Alloy	3/4	M18 FPT114, M18 FPT2	4932480228 4058546405137
	FPTD 1" BSPT Alloy	BSPT Alloy	1	M18 FPT114, M18 FPT2	4932480229 4058546405144
	FPTD 1 1/4" BSPT Alloy	BSPT Alloy	1 - 1/4	M18 FPT114, M18 FPT2	4932480230 4058546405151
c.	FPTD 1 1/2" BSPT Alloy	BSPT Alloy	1 - 1/2	M18 FPT114, M18 FPT2	4932480231 4058546405168
	FPTD 2" BSPT Alloy	BSPT Alloy	2	M18 FPT114, M18 FPT2	4932480232 4058546405175
	FPTD 1/2" BSPT HS	BSPT HS	1/2	M18 FPT114, M18 FPT2	4932480233 4058546405182
	FPTD 3/4" BSPT HS	BSPT HS	3/4	M18 FPT114, M18 FPT2	4932480234 4058546405199
	FPTD 1" BSPT HS	BSPT HS	1	M18 FPT114, M18 FPT2	4932480235 4058546405205
d.	FPTD 1 1/4" BSPT HS	BSPT HS	1 - 1/4	M18 FPT114, M18 FPT2	4932480236 4058546405212
	FPTD 1 1/2" BSPT HS	BSPT HS	1 - 1/2	M18 FPT114, M18 FPT2	4932480237 4058546405229
	FPTD 2" BSPT HS	BSPT HS	2	M18 FPT114, M18 FPT2	4932480238 4058546405236
e.	PTR2D 1/2" - 3/4" NPT HSS	NPT HSS	1/2 - 3/4	MXF PTR2	48361205 045242745876
	PTR2D 1" - 2" NPT HSS	NPT HSS	1 - 2	MXF PTR2	48361206 045242745906
f.	PTR2D 1/2" - 3/4" BSPT Alloy	BSPT Alloy	1/2 - 3/4	MXF PTR2	4932492924 4058546477950
	PTR2D 1" - 2" BSPT Alloy	BSPT Alloy	1 - 2	MXF PTR2	4932492925 4058546477967
g.	PTR2D 1/2" - 3/4" BSPT HS	BSPT HS	1/2 - 3/4	MXF PTR2	4932492926 4058546477974
	PTR2D 1" - 2" BSPT HS	BSPT HS	1 - 2	MXF PTR2	4932492927 4058546477981
h.	PTR2D 1/2" - 3/4" BSPT HSS	BSPT HSS	1/2 - 3/4	MXF PTR2	4932492928 4058546477998
	PTR2D 1" - 2" BSPT HSS	BSPT HSS	1 - 2	MXF PTR2	4932492929 4058546478001

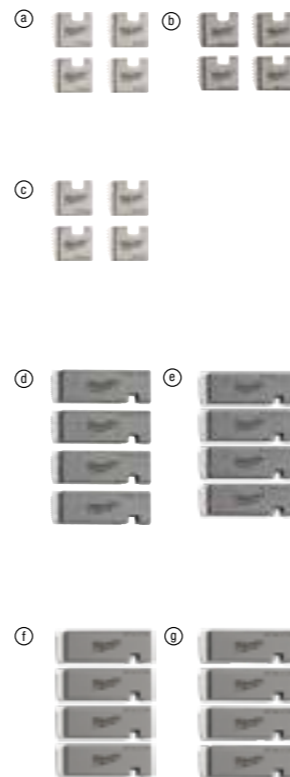

SYSTEM ATTACHMENTS - PIPE THREADER DIE HEADS

- Up to 50% lighter than competitive die heads
- Available sizes from 1/2" up to 2"
- Die heads always include a set of BSPT alloy dies

	Description	Fits MILWAUKEE® pipe threader	Thread size (inch)	Type	Article Number	EAN Code
a.	FPT2H 1/2" BSPT Alloy	FPT2H 1/2" BSPT Alloy	M18 FPT2	1/2	BSPT Alloy	4932480239 4058546405243
	FPT2H 3/4" BSPT Alloy	FPT2H 3/4" BSPT Alloy	M18 FPT2	3/4	BSPT Alloy	4932480240 4058546405250
	FPT2H 1" BSPT Alloy	FPT2H 1" BSPT Alloy	M18 FPT2	1	BSPT Alloy	4932480241 4058546405267
	FPT2H 1-1/4" BSPT Alloy	FPT2H 1 1/4" BSPT Alloy	M18 FPT2	1 1/4	BSPT Alloy	4932480242 4058546405274
	FPT2H 1-1/2" BSPT Alloy	FPT2H 1 1/2" BSPT Alloy	M18 FPT2	1 1/2	BSPT Alloy	4932480243 4058546405281
b.	FPT2H 2" BSPT Alloy	FPT2H 2" BSPT Alloy	M18 FPT2	2	BSPT Alloy	4932480244 4058546405298
	FPT114H 1/2" BSPT Alloy	FPT2H 1/2" BSPT Alloy	M18 FPT114	1/2	BSPT Alloy	4932480245 4058546405304
	FPT114H 3/4" BSPT Alloy	FPT2H 3/4" BSPT Alloy	M18 FPT114	3/4	BSPT Alloy	4932480246 4058546405311
	FPT114H 1" BSPT Alloy	FPT2H 1" BSPT Alloy	M18 FPT114	1	BSPT Alloy	4932480247 4058546405328
	FPT114H 1-1/4" BSPT Alloy	FPT2H 1 1/4" BSPT Alloy	M18 FPT114	1 1/4	BSPT Alloy	4932480248 4058546405335
c.	FPT2HK BSPT Alloy	FPT2HK BSPT alloy PACKOUT™ head kit (6pc)	M18 FPT2	1/2", 3/4", 1", 1 1/4", 1 1/2", 2"	BSPT Alloy	4932480249 4058546405342
d.	FPT114HK BSPT Alloy	FPT114HK BSPT alloy PACKOUT™ head kit (4pc)	M18 FPT114	1/2", 3/4", 1", 1 1/4"	BSPT Alloy	4932480250 4058546405359
e.	PTR2 DH NPT	NPT die head for MX FUEL™ pipe threading machine 2"	MXF PTR2	1/2"-2"	NPT	49165100 045242771264
	PTR2 DH BSPT	BSPT die head for MX FUEL™ pipe threading machine 2"	MXF PTR2	1/2"-2"	BSPT	49165103 045242810109



SYSTEM ATTACHMENTS - MAGNETIC DRILL STANDS

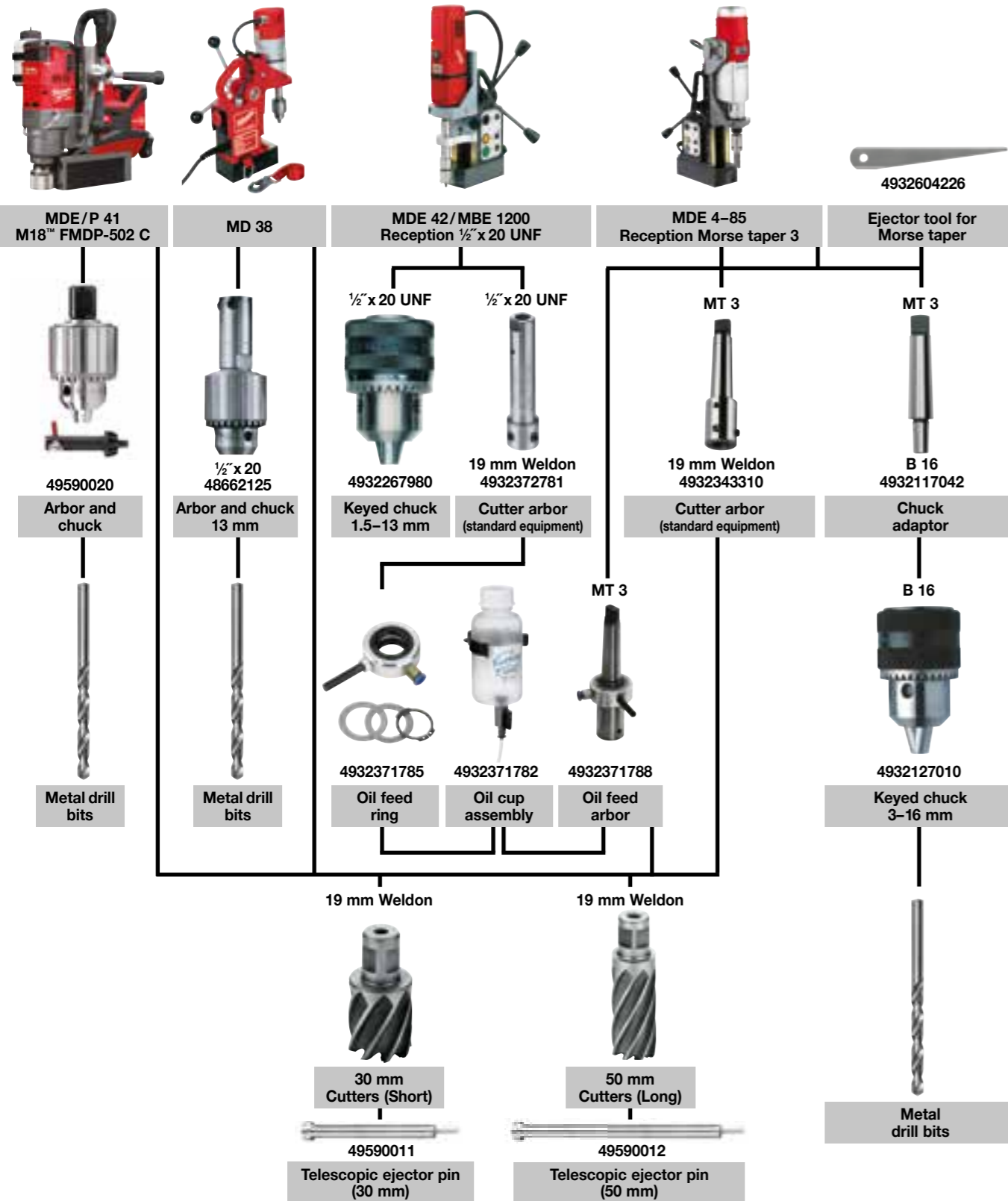

SYSTEM ATTACHMENTS - WET DIAMOND DRILLING

	Description	Fits DD3-152	Fits DCM2-250C & DCM2-350C	Fits MXF DCD150	Fits MXF DCD350	Article Number	EAN Code
a.	Fixing kit	✓	✓	✓	✓	4932399731	4002395363827
	1 3/4" open ended spanner. For holding the motor output spindle while removing a core bit		✓			49964705	04524222766
	32 mm ended spanner. For holding the motor output spindle while removing a core bit.	✓				4931428009	4002395844791
	41 mm open ended spanner. For removing the core bit from the motor spindle.	✓	✓		✓	4931428010	4002395844807
b.	1 1/4" female to 1/2" female adaptor. To enable the connection of <50 mm diamond core bits on a 1 1/4" machine spindle thread	✓	✓		✓	4932352627	4002395372850
c.	1 1/4" female / male extension rod, length 300 mm	✓	✓	✓	✓	4932399724	4002395363759
	1 1/4" female / male extension rod, length 500 mm	✓	✓	✓	✓	4932399725	4002395363766
d.	Telescopic extension. Extension pole used to fix drill rig to the ground instead of anchor bolts. Maximum load of 500 kg and adjustable extension height from 1.8-2.9 m	✓	✓	✓		4932399732	4002395363834
e.	Vacuum pump VP6	✓	✓	✓	✓	4932352094	4002395367474
f.	WT 10 watertank	✓	✓	✓	✓	4932399726	4002395363773
g.	Replacement rubber ring for DR 152 T					4932352678	4002395373369
	Water collection ring: max. Ø 180 mm			✓		4932399727	4002395363780
h.	Replacement rubber ring for DR 250 TV			✓		4932399729	4002395363803
	Water collection ring: For use with drill rig DR 350 T. For use with max. Ø 300 mm core bits					4932399728	4002395363797
i.	Replacement rubber ring for DR 350 T					4932399730	4002395363810
j.	Quick connection motor mounting plate. Included in both drill rigs DR 250 TV and DR 350 T		✓			4932399733	4002395363841
k.	Water collection ring: For universal use with diamond drilling tools. For use with max. Ø 152 mm core bits	✓	✓	✓	✓	4932478073	4058546340063



SYSTEM ATTACHMENTS - DRAIN CLEANERS

	Description	Fits drain cleaners M12BDC6, M12 BDC8	Fits drain cleaners M18 FDCPF8, M18 FDCPF10	Fits drain cleaners M18 FFSDC16, M18 FFSDC13, M18 FFSDC10	Fits drain cleaners MXF LSDP	Article Number	EAN Code
a.	Open wind spiral SD	16 mm x 15.2 m open wind coupling end		✓		48532775	045242513109
b.		6 mm x 7.6 m inner core bulb head	✓			48532573	045242471270
		8 mm x 7.6 m inner core drop head	✓			48532572	045242364206
c.	Tight wind spiral HH	6 mm x 7.6 m inner core drop head	✓			48532574	045242471287
		6 mm x 10.6 m inner core bulb head		✓		48532671	045242482740
		6 mm x 15.2 m inner core bulb head		✓		48532672	045242482757
		8 mm x 7.6 m inner core bulb head	✓			48532571	045242364213
		8 mm x 10.6 m inner core bulb head		✓		48532673	045242482764
		8 mm x 15.2 m inner core bulb head	✓			48532674	045242482771
d.		10 mm x 10.6 m inner core coupling end		✓		48532675	045242482788
		8 mm x 7.6 m inner core bulb head drum	✓			48532581	045242480586
		8 mm x 7.6 m inner core drop head drum	✓			48532582	045242480593
		6 mm x 7.6 m inner core bulb head drum	✓			48532583	045242480609
e.	Tight wind spiral SD	6 mm x 7.6 m inner core drop head drum	✓			48532584	045242480616
		8 mm x 23 m inner core bulb head		✓		48532772	045242513079
		10 mm x 15.2 m inner core coupling end		✓		48532773	045242513086
		13 mm x 15.2 m inner core coupling end		✓		48532774	045242513093
f.		16 mm x 7.6 m inner core coupling end			✓	4932471701	4058546296001
		16 mm x 15.2 m inner core coupling end			✓	4932471702	4058546296018
		20 mm x 7.6 m inner core coupling end			✓	4932471703	4058546296025
		20 mm x 15.2 m inner core coupling end			✓	4932471704	4058546296032
g.	Bulb auger HH	16 mm anchor cable coupling end			✓	4932471707	4058546296063
		16 mm x 60 cm leader cable coupling end			✓	4932471708	4058546296070
h.	C-cutter HH	20 mm x 600 mm leader cable coupling end			✓	4932471709	4058546296087
		Small bulb auger for 10, 13, 16 mm cables		✓	✓	48532681	045242503803
i.	C-cutter SD	Small C cutter for 10, 13, 16 mm cables	✓	✓	48532684	045242503834	
j.	Chain knocker SD	Medium C cutter for 10, 13, 16 mm cables	✓	✓	48532789	045242006137	
		75 mm chain knocker for 16, 20 mm cables			✓	48532837	4058546323448
k.	Drop head HH	100 mm chain knocker for 16, 20 mm cables			✓	48532838	4058546323455
		Small drop head for 10, 13, 16 mm cables	✓	✓	48532682	045242503810	
l.	Drop head SD	Medium drop head for 10, 13, 16 mm cables	✓	✓	48532787	045242006113	
		Funnel auger for 16, 20 mm cables			✓	48532831	4058546323387
m.	Funnel auger SD	Medium funnel auger for 10, 13, 16 mm cables	✓	✓	48532786	045242006106	
		Small 5 pc head kit for 10, 13, 16 mm cables	✓	✓	48532685	045242503841	
n.	Head kit HH	Medium 5 pc head kit for 10, 13, 16 mm cables	✓	✓	48532790	045242006144	
		9 pc head kit 16, 20 mm cables			✓	48532840	4058546296131
o.	Head kit SD	Small opening tool for 16, 20 mm cables			✓	48532835	4058546323424
		Medium opening tool for 16, 20 mm cables			✓	48532836	4058546323431
p.	Opening tool SD	75 mm root cutter for 16, 20 mm cables			✓	48532832	4058546323394
		100 mm root cutter for 16, 20 mm cables			✓	48532833	4058546323400
		150 mm root cutter for 16, 20 mm cables			✓	48532834	4058546323417
r.	Spade bit HH	Small spade bit for 10, 13, 16 mm cables	✓	✓	48532683	045242503827	
s.	Spade bit SD	Medium spade bit for 10, 13, 16 mm cables	✓	✓	48532788	045242006120	
t.	Straight auger SD	Straight auger for 16, 20 mm cables			✓	48532830	4058546323370
u.	SWITCH PACK™ autofeed	SWITCH PACK™ auto feed for M18 FFSDC series		✓		4932471993	4058546298920
v.	SWITCH PACK™ guidehose	Guide hose for SWITCH PACK™ auto feed		✓		4932471994	4058546298937
w.	SWITCH PACK™ base plate autofeed	Base plate for SWITCH PACK™ auto feed		✓		4932478225	4058546344023
x.	SWITCH PACK™ drum	SWITCH PACK™ drum for M18 FFSDC series		✓		4932464277	4058546222222
y.	MX drum guide hose	Guide hose for MXFLSDP		✓		4932478110	4058546340421
z.	Pin key	Pin key for all cables	✓	✓	✓	4932471717	4058546296162



SYSTEM ATTACHMENTS - SECTIONAL SEWER MACHINES

	Description	Fits sewer machine M18 FCSSM	Fits sewer machine M18 FSSM	Article Number	EAN Code		
a.	Open wind spiral SM	16 mm x 2.3 m open wind coupling end	✓		4932478413	4058546346041	
		16 mm x 2.3 m open wind inner core coupling	✓		4932478414	4058546346058	
		22 mm x 4.5 m open wind inner core coupling end	✓	✓	4932478415	4058546346065	
		22 mm x 4.5 m open wind coupling end	✓	✓	4932471712	4058546296117	
		22 mm x 4.5 m open wind coupling end kit	✓	✓	4932471713	4058546296124	
		32 mm x 4.5 m open wind coupling end		✓	4932471710	4058546296094	
b.	Drop head SM	32 mm x 4.5 m open wind heavy duty coupling end	✓		4932471711	4058546296100	
		Drop head bulb 16 mm cables	✓		48533811	4058546346133	
c.	Funnel auger SM	Drop head straight 16 mm cables	✓		48533812	4058546346126	
		Funnel auger for 16 mm cables	✓		48533813	4058546346140	
		Small funnel auger for 22 mm cables	✓	✓	48533828	4058546346089	
d.	Opening tool SM	Medium funnel auger for 22 mm cables	✓	✓	48533831	4058546323479	
		Funnel auger for 32 mm cables		✓	48534831	4058546323561	
		Extra small opening tool for 16 mm cables	✓		48533814	4058546346157	
e.	Spring cleaner SM	Small opening tool for 16 mm cables	✓		48533815	4058546346164	
		Small opening tool for 22 mm cables	✓	✓	48533827	4058546346096	
		Small opening tool for 22 mm cables	✓	✓	48533835	4058546323516	
		Medium opening tool for 22 mm cables	✓	✓	48533836	4058546323523	
		Small opening tool for 32 mm cables		✓	48534835	4058546323608	
		Medium opening tool for 32 mm cables		✓	48534836	4058546323615	
f.	Root cutter SM	Spring cleaner for 16 mm cables	✓		48533816	4058546346171	
		50 mm root cutter for 22 mm cables	✓	✓	48533825	4058546346119	
		75 mm root cutter for 22 mm cables	✓	✓	48533832	4058546323486	
		100 mm root cutter for 22 mm cables	✓	✓	48533833	4058546323493	
		150 mm root cutter for 22 mm cables	✓	✓	48533834	4058546323509	
		75mm root cutter for 32 mm cables		✓	48534832	4058546323578	
g.	Straight auger SM	100 mm root cutter for 32 mm cables	✓	✓	48534833	4058546323585	
		150 mm root cutter for 32 mm cables	✓	✓	48534834	4058546323592	
		Small straight auger for 22 mm cables	✓	✓	48533829	4058546346072	
h.	Chain knocker SM	Medium straight auger for 22 mm cables	✓	✓	48533830	4058546323462	
		Straight auger for 32 mm cables		✓	48534830	4058546323554	
i.	Head kit SM	75 mm chain knocker for 22 mm spirals	✓	✓	48533837	4058546323530	
		100 mm chain knocker 22 mm cables	✓	✓	48533838	4058546323547	
		75 mm chain knocker for 32 mm spirals		✓	48534837	4058546323622	
j.	Medium guide hose	100 mm chain knocker 32 mm cables		✓	48534838	4058546323639	
		9pc head kit for 22 mm cables	✓	✓	48533840	4058546296148	
k.	Cable drum	9pc head kit for 32 mm cables		✓	48534839	4058546296155	
		Small guide hose	Small guide hose for FCSSM	✓		4932478410	4058546346010
		Medium guide hose	Medium guide hose for FCSSM	✓		4932478409	4058546346003
l.	Pin key	Large guide hose		✓	4932471720	4058546296193	
		Cable drum for 16mm spirals	✓		4932478412	4058546346034	
m.		Cable drum for 22mm spirals	✓	✓	4932478411	4058546346027	
		Cable drum for 32mm spirals		✓	4932471719	4058546296186	

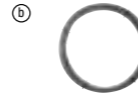

SYSTEM ATTACHMENTS - FLEXIBLE SHAFT MACHINE

	Name	Description	Fits MILWAUKEE® flexible shaft machine	Article Number	EAN Code
a.	Lubrication oil	HSFSM-OIL	Lubrication oil for M18™ high speed flexible shaft machine	M18 HSFSM 4932480905	4058546411909
b.	Replacement cables	HSFSM-RC8	23 m replacement cable with 8 mm reception for M18™ high speed flexible shaft machine	M18 HSFSM 4932480723	4058546410087
		HSFSM-RC-6	Replacement cable for M12™ high speed flexible shaft machine	M12 HSFSM 4932499172	4058546563363
c.	Standard chains	HSFSM-SC3240	32 - 40 mm standard chain for M18™ high speed flexible shaft machine	M18 HSFSM 4932480724	4058546410094
		HSFSM-SC3240-6	Standard chain 32 mm - 40 mm for M12™ high speed flexible shaft machine	M12 HSFSM 4932499167	4058546563318
		HSFSM-SC50	50 mm standard chain for M18™ high speed flexible shaft machine	M18 HSFSM 4932480725	4058546410100
		HSFSM-SC50-6	Standard chain 50 mm for M12™ high speed flexible shaft machine	M12 HSFSM 4932499168	4058546563325
		HSFSM-SC75	75 mm standard chain for M18™ high speed flexible shaft machine	M18 HSFSM 4932480726	4058546410117
		HSFSM-SC110	110 mm standard chain for M18™ high speed flexible shaft machine	M18 HSFSM 4932480727	4058546410124
		HSFSM-CC3240	32 - 40 mm carbide chain for M18™ high speed flexible shaft machine	M18 HSFSM 4932480728	4058546410131
		HSFSM-CC3240-6	Carbide chain 32 - 40 mm for M12™ high speed flexible shaft machine	M12 HSFSM 4932499169	4058546563332
		HSFSM-CC50	50 mm carbide chain for M18™ high speed flexible shaft machine	M18 HSFSM 4932480729	4058546410148
		HSFSM-CC50-6	Carbide chain 50 mm for M12™ high speed flexible shaft machine	M12 HSFSM 4932499170	4058546563349
d.	Carbide chains	HSFSM-CC75	75 mm carbide chain for M18™ high speed flexible shaft machine	M18 HSFSM 4932480730	4058546410155
		HSFSM-CC110	110 mm carbide chain for M18™ high speed flexible shaft machine	M18 HSFSM 4932480731	4058546410162
		HSFSM-PH	Penetrating head for M18™ high speed flexible shaft machine	M18 HSFSM 4932480732	4058546410179
e.	Penetrating heads	HSFSM-PH-6	Penetrating head for M12™ high speed flexible shaft machine	M12 HSFSM 4932499171	4058546563356



SYSTEM ATTACHMENTS - PRESS JAWS

PROFILE M

Jaw profile	Fits to following pipe system suppliers	Fits MILWAUKEE® press tool	Nominal size	Tool suitability	Description	Requires	Article Number	EAN Code	
a.	M	Geberit: Mapress VSH: X-Press Eurotubi Raccorderie Metallique Rubinetteria Bresciane Sanha: Nirosan Pegler Yorkshire	M12 HPT, M12 ONEHPT	12	M12	J12-M12	-	4932430243	4002395379040
			M12 HPT, M12 ONEHPT	15	M12	J12-M15	-	4932430245	4002395379064
			M12 HPT, M12 ONEHPT	18	M12	J12-M18	-	4932430247	4002395379088
			M12 HPT, M12 ONEHPT	22	M12	J12-M22	-	4932430249	4002395379101
			M12 HPT, M12 ONEHPT	28	M12	J12-M28	-	4932430251	4002395379125
			M12 HPT, M12 ONEHPT	35	M12	J12-M35	-	4932430253	4002395379149
			M18 HPT, M18 BLHPT	12	M18	J18-M12	-	4932430244	4002395379057
			M18 HPT, M18 BLHPT	15	M18	J18-M15	-	4932430246	4002395379071
			M18 HPT, M18 BLHPT	18	M18	J18-M18	-	4932430248	4002395379095
			M18 HPT, M18 BLHPT	22	M18	J18-M22	-	4932430250	4002395379118
			M18 HPT, M18 BLHPT	28	M18	J18-M28	-	4932430252	4002395379132
			M12 HPT	35	M18	J18-M35	-	4932430254	4002395379156
			M18 HPT, M18 BLHPT	42	M18	RJ18-M42	RJA-1	4932430255	4002395379163
			M18 HPT, M18 BLHPT	54	M18	RJ18-M54	RJA-1	4932430256	4002395379170
			M18 HPT, M18 BLHPT	-	-	-	RJA-1	4932430307	4002395379682
			M18 BLHPTXL	76.1	M18	RJ18XL-M76,1	RJAXL-1	4932479458	4058546372521
			M18 BLHPTXL	88.9	M18	RJ18XL-M88,9	RJAXL-1	4932479459	4058546372538
			M18 BLHPTXL	108	M18	RJ18XL-M108	RJAXL-1 & RJAXL-2	4932479460	4058546372545
M18 BLHPTXL	-	M18	-	RJAXL-1	4932479451	4058546372453			
M18 BLHPTXL	-	M18	-	RJAXL-2	4932479452	4058546372460			

PROFILE V

Jaw profile	Fits to following pipe system suppliers	Fits MILWAUKEE® press tool	Nominal size	Tool suitability	Description	Requires	Article Number	EAN Code	
a.	V	Viega Comap IBP Sanha: Nirosan	M12 HPT, M12 ONEHPT	12	M12	J12-V12	-	4932430260	4002395379217
			M12 HPT, M12 ONEHPT	14	M12	J12-V14	-	4932451660	4002395273423
			M12 HPT, M12 ONEHPT	15	M12	J12-V15	-	4932430262	4002395379231
			M12 HPT, M12 ONEHPT	16	M12	J12-V16	-	4932451661	4002395273430
			M12 HPT, M12 ONEHPT	18	M12	J12-V18	-	4932430264	4002395379255
			M12 HPT, M12 ONEHPT	22	M12	J12-V22	-	4932430266	4002395379279
			M12 HPT, M12 ONEHPT	28	M12	J12-V28	-	4932430268	4002395379293
			M12 HPT, M12 ONEHPT	35	M12	J12-V35	-	4932430270	4002395379316
			M18 HPT, M18 BLHPT	12	M18	J18-V12	-	4932430261	4002395379224
			M18 HPT, M18 BLHPT	14	M18	J18-V14	-	4932471086	4058546287146
			M18 HPT, M18 BLHPT	15	M18	J18-V15	-	4932430263	4002395379248
			M18 HPT, M18 BLHPT	16	M18	J18-V16	-	4932471087	4058546287153
			M18 HPT, M18 BLHPT	18	M18	J18-V18	-	4932430265	4002395379262
			M18 HPT, M18 BLHPT	22	M18	J18-V22	-	4932430267	4002395379286
			M18 HPT, M18 BLHPT	28	M18	J18-V28	-	4932430269	4002395379309
			M18 HPT, M18 BLHPT	35	M18	J18-V35	-	4932430271	4002395379323
			M18 HPT, M18 BLHPT	42	M18	RJ18-V42	RJA-1	4932430272	4002395379330
			M18 HPT, M18 BLHPT	54	M18	RJ18-V54	RJA-1	4932430273	4002395379347
M18 HPT, M18 BLHPT	-	M18	-	RJA-1	4932430307	4002395379682			
M18 BLHPT, M18 ONEBLHPT	76.1	M18	RJ18-V76,1	RJAV-2	4932479455	4058546372491			
M18 BLHPT, M18 ONEBLHPT	88.9	M18	RJ18-V88,9	RJAV-2	4932479456	4058546372507			
M18 BLHPT, M18 ONEBLHPT	108	M18	RJ18-V108	RJAV-2	4932479457	4058546372514			
M18 BLHPT, M18 ONEBLHPT	-	M18	-	RJAV-2	4932479604	4058546373986			

PROFILE U

Jaw profile	Fits to following pipe system suppliers	Fits MILWAUKEE® press tool	Nominal size	Tool suitability	Description	Requires	Article Number	EAN Code	
a.	U	ALB Uponor: Unipipe, Airpipe Kan: Kan-therm Wavin: Press-Systeme Frankische: Apex F50 Profi DW Verbundrohr Multitubo IBP: >B-Flex KE Kelit: Kelit Kelox Jupiter: Heizsystem	M12 HPT, M12 ONEHPT	14	M12	J12-U14	-	4932430291	4002395379521
			M12 HPT, M12 ONEHPT	16	M12	J12-U16	-	4932430293	4002395379545
			M12 HPT, M12 ONEHPT	18	M12	J12-U18	-	4932430295	4002395379569
			M12 HPT, M12 ONEHPT	20	M12	J12-U20	-	4932430297	4002395379583
			M12 HPT, M12 ONEHPT	25	M12	J12-U25	-	4932430299	4002395379606
			M12 HPT, M12 ONEHPT	32	M12	J12-U32	-	4932430301	4002395379620
			M12 HPT, M12 ONEHPT	40	M12	J12-U40	-	4932430303	4002395379644
			M18 HPT, M18 BLHPT	14	M18	J18-U14	-	4932430292	4002395379538
			M18 HPT, M18 BLHPT	16	M18	J18-U16	-	4932430294	4002395379552
			M18 HPT, M18 BLHPT	18	M18	J18-U18	-	4932430296	4002395379576
			M18 HPT, M18 BLHPT	20	M18	J18-U20	-	4932430298	4002395379590
			M18 HPT, M18 BLHPT	25	M18	J18-U25	-	4932430300	4002395379613
b.	U	ALB Uponor: Unipipe, Airpipe Kan: Kan-therm Wavin: Press-Systeme Frankische: Apex F50 Profi DW Verbundrohr Multitubo IBP: >B-Flex KE Kelit: Kelit Kelox Jupiter: Heizsystem	M18 HPT, M18 BLHPT	32	M18	J18-U32	-	4932430302	4002395379637
			M18 HPT, M18 BLHPT	40	M18	RJ18-U40	RJA-1	4932430304	4002395379651
			M18 HPT, M18 BLHPT	50	M18	RJ18-U50	RJA-1	4932430305	4002395379668
			M18 HPT, M18 BLHPT	63	M18	RJ18-U63	RJA-1	4932430306	4002395379675
			M18 HPT, M18 BLHPT	-	M18	-	RJA-1	4932430307	4002395379682



PROFILE G

Jaw profile	Fits to following pipe system suppliers	Fits MILWAUKEE® press tool	Nominal size	Tool suitability	Description	Requires	Article Number	EAN Code	
a.	G	Geberit: Mepla & Mepla Therm	M12 HPT, M12 ONEHPT	16	M12	J12-G16	-	4932464217	4058546221621
			M12 HPT, M12 ONEHPT	20	M12	J12-G20	-	4932464218	4058546221638
			M12 HPT, M12 ONEHPT	26	M12	J12-G26	-	4932464219	4058546221645
			M12 HPT, M12 ONEHPT	32	M12	J12-G32	-	4932464220	4058546221652
			M12 HPT, M12 ONEHPT	40	M12	J12-G40	-	4932464221	4058546221669
			M18 HPT, M18 BLHPT	16	M18	J18-G16	-	4932464544	4058546224899
			M18 HPT, M18 BLHPT	20	M18	J18-G20	-	4932464545	4058546224905
			M18 HPT, M18 BLHPT	26	M18	J18-G26	-	4932464546	4058546224912
			M18 HPT, M18 BLHPT	32	M18	J18-G32	-	4932464547	4058546224929
			M18 HPT, M18 BLHPT	40	M18	J18-G40	-	4932464548	4058546224936
b.	G	Geberit: Mepla & Mepla Therm	M18 HPT, M18 BLHPT	50	M18	J18-G50	-	4932464549	4058546224943



PROFILE TH

Jaw profile	Fits to following pipe system suppliers	Fits MILWAUKEE® press tool	Nominal size	Tool suitability	Description	Requires	Article Number	EAN Code	
a.	TH	ALB Comap Frankische Henco (nur TH14 - TH25) IPA Sanha Tiemme	M12 HPT, M12 ONEHPT	14	M12	J12-TH14	-	4932430274	4002395379354
			M12 HPT, M12 ONEHPT	16	M12	J12-TH16	-	4932430276	4002395379378
			M12 HPT, M12 ONEHPT	18	M12	J12-TH18	-	4932430278	4002395379392
			M12 HPT, M12 ONEHPT	20	M12	J12-TH20	-	4932430280	4002395379415
			M12 HPT, M12 ONEHPT	25	M12	J12-TH25	-	4932430282	4002395379439
			M12 HPT, M12 ONEHPT	26	M12	J12-TH26	-	4932430283	4002395379446
			M12 HPT, M12 ONEHPT	32	M12	J12-TH32	-	4932430285	4002395379460
			M12 HPT, M12 ONEHPT	40	M12	J12-TH40	-	4932430287	4002395379484
			M18 HPT, M18 BLHPT	14	M18	J18-TH14	-	4932430275	4002395379361
			M18 HPT, M18 BLHPT	16	M18	J18-TH16	-	4932430277	4002395379385
b.	TH	ALB Comap Frankische Henco (nur TH14 - TH25) IPA Sanha Tiemme	M18 HPT, M18 BLHPT	18	M18	J18-TH18	-	4932430279	4002395379408
			M18 BLHPT, M18 HPT	20	M18	J18-TH20	-	4932430281	4002395379422
			M18 HPT, M18 BLHPT	25	M18	J18-TH25	-	4932430355	4002395380169
			M18 HPT, M18 BLHPT	26	M18	J18-TH26	-	4932430284	4002395379453
			M18 HPT, M18 BLHPT	32	M18	J18-TH32	-	4932430286	4002395379477
			M18 BLHPT, M18 HPT	40	M18	RJ18-TH40	RJA-1	4932430288	4002395379491
			M18 HPT, M18 BLHPT	50	M18	RJ18-TH50	RJA-1	4932430289	4002395379507
			M18 HPT, M18 BLHPT	63	M18	RJ18-TH63	RJA-1	4932430290	4002395379514
			M18 HPT, M18 BLHPT	-	M18	RJA-1	-	4932430307	4002395379682



PROFILE VIEGA MEGA PRESS

Jaw profile	Fits to following pipe system suppliers	Fits MILWAUKEE® press tool	Nominal size	Tool suitability	Description	Requires	Article Number	EAN Code	
a.	MP	Viega: Mega Press	M18 BLHPT, M18 ONE-BLHPT, M18 BLHPTXL	1/2"	M18	J18-MP1/2"	-	4932479442	4058546372361
			M18 BLHPT, M18 ONE-BLHPT, M18 BLHPTXL	3/4"	M18	J18-MP3/4"	-	4932479443	4058546372378
			M18 BLHPT, M18 ONE-BLHPT, M18 BLHPTXL	1"	M18	J18-MP1"	-	4932479444	4058546372385
			M18 BLHPT, M18 ONE-BLHPT, M18 BLHPTXL	1 1/4"	M18	RJ18-MP1 1/4"	RJA-1	4932479445	4058546372392
			M18 BLHPT, M18 ONE-BLHPT, M18 BLHPTXL	1 1/2"	M18	RJ18-MP1 1/2"	RJA-1	4932479446	4058546372408
			M18 BLHPT, M18 ONE-BLHPT, M18 BLHPTXL	2"	M18	RJ18-MP2"	RJA-1	4932479447	4058546372415
			M18 BLHPTXL	2 1/2"	M18	RJ18XL-MP2 1/2"	RJAXL-1	4932479448	4058546372422
			M18 BLHPTXL	3"	M18	RJ18XL-MP3"	RJAXL-1	4932479449	4058546372439
			M18 BLHPTXL	4"	M18	RJ18XL-MP4"	RJAXL-1	4932479450	4058546372446
			M18 BLHPTXL	-	M18	RJAXL-1	-	4932479451	4058546372453



PROFILE FF

Jaw profile	Fits to following pipe system suppliers	Fits MILWAUKEE® press tool	Nominal size	Tool suitability	Description	Requires	Article Number	EAN Code	
a.	FF	Geberit FlowFit	M12 HPT, M12 ONEHPT	16-40	M12	J12-FF 16-40 Geberit	-	4932480981	4058546412661
			M18 BLHPT, M18 ONEBLHPT	16-40	M18	J18-FF 16-40 Geberit	-	4932480982	4058546412678
			M18 BLHPT, M18 ONEBLHPT	50-75	M18	J18-FF 50-75 Geberit	-	4932480983	4058546412685



PROFILE M 2

Jaw profile	Fits to following pipe system suppliers	Fits MILWAUKEE® press tool	Nominal size	Tool suitability	Description	Requires	Article Number	EAN Code	
a.	M	Geberit: M2press	M12 HPT, M12 ONEHPT	12	M12	J12-M12 Geberit	-	4932480879	4058546411640
			M12 HPT, M12 ONEHPT	15	M12	J12-M15 Geberit	-	4932480880	4058546411657
			M12 HPT, M12 ONEHPT	18	M12	J12-M18 Geberit	-	4932480881	4058546411664
			M12 HPT, M12 ONEHPT	22	M12	J12-M22 Geberit	-	4932480882	4058546411671
			M12 HPT, M12 ONEHPT	28	M12	J12-M28 Geberit	-	4932480883	4058546411688
			M12 HPT, M12 ONEHPT	35	M12	J12-M35 Geberit	-	4932480884	4058546411695
			M18 BLHPT, M18 ONEBLHPT	12	M18	J18-M12 Geberit	-	4932480885	4058546411701
			M18 BLHPT, M18 ONEBLHPT	15	M18	J18-M15 Geberit	-	4932480886	4058546411718
			M18 BLHPT, M18 ONEBLHPT	18	M18	J18-M18 Geberit	-	4932480887	4058546411725
			M18 BLHPT, M18 ONEBLHPT	22	M18	J18-M22 Geberit	-	4932480888	4058546411732
b.	M	Geberit: M2press	M18 BLHPT, M18 ONEBLHPT	28	M18	J18-M28 Geberit	-	4932480889	4058546411749
			M18 BLHPT, M18 ONEBLHPT	35	M18	J18-M35 Geberit	-	4932480890	4058546411756

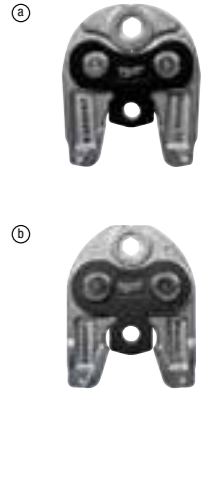

PROFILE G 2

Jaw profile	Fits to following pipe system suppliers	Fits MILWAUKEE® press tool	Nominal size	Tool suitability	Description	Requires	Article Number	EAN Code	
a.	G	Geberit: Mepla & Mepla Therm	M12 HPT, M12 ONEHPT	16	M12	J12-G16 Geberit	-	4932480891	4058546411763
			M12 HPT, M12 ONEHPT	20	M12	J12-G20 Geberit	-	4932480892	4058546411770
			M12 HPT, M12 ONEHPT	26	M12	J12-G26 Geberit	-	4932480893	4058546411787
			M12 HPT, M12 ONEHPT	32	M12	J12-G32 Geberit	-	4932480894	4058546411794
			M12 HPT, M12 ONEHPT	40	M12	J12-G40 Geberit	-	4932480895	4058546411800
			M18 BLHPT, M18 ONEBLHPT	16	M18	J18-G16 Geberit	-	4932480896	4058546411817
			M18 BLHPT, M18 ONEBLHPT	20	M18	J18-G20 Geberit	-	4932480897	4058546411824
			M18 BLHPT, M18 ONEBLHPT	26	M18	J18-G26 Geberit	-	4932480898	4058546411831
			M18 BLHPT, M18 ONEBLHPT	32	M18	J18-G32 Geberit	-	4932480899	4058546411848
			M18 BLHPT, M18 ONEBLHPT	40	M18	J18-G40 Geberit	-	4932480900	4058546411855
b.	G	Geberit: Mepla & Mepla Therm	M18 BLHPT, M18 ONEBLHPT	50	M18	J18-G50 Geberit	-	4932480901	4058546411862
			M18 BLHPT, M18 HPT	63	M18	RJ18-G63 Geberit	-	4932480966	4058546412517
			M18 BLHPT, M18 HPT	75	M18	RJ18-G75 Geberit	-	4932480967	4058546412524
			M18 BLHPT, M18 HPT	-	M18	RJA Geberit	-	4932480968	4058546412531



PROFILE BPM

Jaw profile	Fits to following pipe system suppliers	Fits MILWAUKEE® press tool	Nominal size	Tool suitability	Description	Requires	Article Number	EAN Code	
a.	BMP	Conex & Bänninger >B< MaxiPro	M12 HPT, M12 ONEHPT	1/4"	M12	J12-BMP 1/4"	-	4932493155	4058546480264
			M12 HPT, M12 ONEHPT	3/8"	M12	J12-BMP 3/8"	-	4932493156	4058546480271
			M12 HPT, M12 ONEHPT	1/2"	M12	J12-BMP 1/2"	-	4932493157	4058546480288
			M12 HPT, M12 ONEHPT	5/8"	M12	J12-BMP 5/8"	-	4932493158	4058546480295
			M12 HPT, M12 ONEHPT	3/4"	M12	J12-BMP 3/4"	-	4932493159	4058546480301
			M12 HPT, M12 ONEHPT	7/8"	M12	J12-BMP 7/8"	-	4932493160	4058546480318
			M12 HPT, M12 ONEHPT	1"	M12	J12-BMP 1"	-	4932493161	4058546480325
			M12 HPT, M12 ONEHPT	1 1/8"	M12	J12-BMP 1 1/8"	-	4932493162	4058546480332
			M18 BLHPT, M18 BLHPTXL, M18 ONEBLHPT	1/4"	M18	J18-BMP 1/4"	-	4932493163	4058546480349
			M18 BLHPT, M18 BLHPTXL, M18 ONEBLHPT	3/8"	M18	J18-BMP 3/8"	-	4932493164	4058546480356
b.	BMP	Conex & Bänninger >B< MaxiPro	M18 BLHPTXL, M18 BLHPT, M18 ONEBLHPT	1/2"	M18	J18-BMP 1/2"	-	4932493165	4058546480363
			M18 BLHPT, M18 BLHPTXL, M18 ONEBLHPT	5/8"	M18	J18-BMP 5/8"	-	4932493166	4058546480370
			M18 BLHPT, M18 BLHPTXL, M18 ONEBLHPT	3/4"	M18	J18-BMP 3/4"	-	4932493167	4058546480387
			M18 BLHPT, M18 BLHPTXL, M18 ONEBLHPT	7/8"	M18	J18-BMP 7/8"	-	4932493168	4058546480394
			M18 BLHPT, M18 BLHPTXL, M18 ONEBLHPT	1"	M18	J18-BMP 1"	-	4932493169	4058546480400
			M18 BLHPT, M18 BLHPTXL, M18 ONEBLHPT	1 1/8"	M18	J18-BMP 1 1/8"	-	4932493170	4058546480417



PIVOTING RING JAWS

Jaw profile	Fits to following pipe system suppliers	Fits MILWAUKEE® press tool	Nominal size	Tool suitability	Description	Requires	Article Number	EAN Code
a. M	Geberit: Mapress VSH: X-Press Eurotubi Raccorderie Metallique Rubinetteria Bresciane Sanha: Nirosan Pegler Yorkshire	M12 HPT, M12 ONEHPT, M18 BLHPT, M18 ONEBLHPT	15	M12/M18	PRJ12/18-M15	PRJA-M12/ PRJA-M18	4932500083	4058546572471
		M12 HPT, M12 ONEHPT, M18 BLHPT, M18 ONEBLHPT	18	M12/M18	PRJ12/18-M18	PRJA-M12/ PRJA-M18	4932500084	4058546572488
		M12 HPT, M12 ONEHPT, M18 BLHPT, M18 ONEBLHPT	22	M12/M18	PRJ12/18-M22	PRJA-M12/ PRJA-M18	4932500085	4058546572495
		M12 HPT, M12 ONEHPT, M18 BLHPT, M18 ONEBLHPT	28	M12/M18	PRJ12/18-M28	PRJA-M12/ PRJA-M18	4932500086	4058546572501
		M12 ONEHPT, M12 HPT, M18 BLHPT, M18 ONEBLHPT	35	M12/M18	PRJ12/18-M35	PRJA-M12/ PRJA-M18	4932500087	4058546572518
b. V	Viega Comap IBP Sanha: Nirosan	M12 HPT, M12 ONEHPT, M18 BLHPT, M18 ONEBLHPT	15	M12/M18	PRJ12/18-V15	PRJA-M12/ PRJA-M18	4932500088	4058546572525
		M12 HPT, M12 ONEHPT, M18 BLHPT, M18 ONEBLHPT	18	M12/M18	PRJ12/18-V18	PRJA-M12/ PRJA-M18	4932500089	4058546572532
		M12 HPT, M12 ONEHPT, M18 BLHPT, M18 ONEBLHPT	22	M12/M18	PRJ12/18-V22	PRJA-M12/ PRJA-M18	4932500090	4058546572549
		M12 HPT, M12 ONEHPT, M18 BLHPT, M18 ONEBLHPT	28	M12/M18	PRJ12/18-V28	PRJA-M12/ PRJA-M18	4932500091	4058546572556
		M12 HPT, M12 ONEHPT, M18 BLHPT, M18 ONEBLHPT	35	M12/M18	PRJ12/18-V35	PRJA-M12/ PRJA-M18	4932500092	4058546572563

PRESS JAW ACR STREAMLINE

Jaw profile	Fits to following pipe system suppliers	Fits MILWAUKEE® press tool	Nominal size	Tool suitability	Description	Requires	Article Number	EAN Code
a. ACR	Sanha Streamline ACR	M18 BLHPT, M18 BLHPTXL, M18 ONEBLHPT	1/2"	M18	J18-ACR 1/2"	-	4932500103	4058546572679
		M12 HPT, M12 ONEHPT	1/2"	M12	J12-ACR 1/2"	-	4932500097	4058546572617
		M18 BLHPT, M18 BLHPTXL, M18 ONEBLHPT	1/4"	M18	J18-ACR 1/4"	-	4932500101	4058546572655
		M12 HPT, M12 ONEHPT	1/4"	M12	J12-ACR 1/4"	-	4932500095	4058546572594
		M18 ONEBLHPT, M18 BLHPTXL, M18 BLHPT	3/4"	M18	J18-ACR 3/4"	-	4932500105	4058546572693
		M12 HPT, M12 ONEHPT	3/4"	M12	J12-ACR 3/4"	-	4932500099	4058546572631
		M18 BLHPT, M18 BLHPTXL, M18 ONEBLHPT	3/8"	M18	J18-ACR 3/8"	-	4932500102	4058546572662
		M12 HPT, M12 ONEHPT	3/8"	M12	J12-ACR 3/8"	-	4932500096	4058546572600
		M18 BLHPTXL, M18 BLHPT, M18 ONEBLHPT	5/8"	M18	J18-ACR 5/8"	-	4932500104	4058546572686
		M12 HPT, M12 ONEHPT	5/8"	M12	J12-ACR 5/8"	-	4932500098	4058546572624
		M18 BLHPTXL, M12 ONEHPT, M18 ONEBLHPT	7/8"	M18	J18-ACR 7/8"	-	4932500106	4058546572709
		M12 HPT, M12 ONEHPT	7/8"	M12	J12-ACR 7/8"	-	4932500100	4058546572648
		M18 BLHPTXL, M18 BLHPT, M18 ONEBLHPT	1 1/8"	M18	RJ18-ACR 1 1/8"	RJA-1	4932500107	4058546572716
		M18 BLHPTXL, M18 BLHPT, M18 ONEBLHPT	1 3/8"	M18	RJ18-ACR 1 3/8"	RJA-1	4932500108	4058546572723

EMPTY PACKOUT™ FOAM INSERT

Description	Article Number	EAN Code
Empty M12 HPT presstool PACKOUT™ foam insert	4932498246	4058546521158
Empty M18 BLHPT/ONEBLHPT presstool PACKOUT™ foam insert	4932498247	4058546521165
Empty 4x ring jaw and RJ adaptor PACKOUT™ foam insert	4932498248	4058546521172
Empty M108 XL presskit PACKOUT™ foam insert	4932498249	4058546521189



SYSTEM ATTACHMENTS - SANDERS

BELT SANDERS

Description	Fits belt sanders	Article Number	EAN Code
a. Dust bag (spare)	BS 100 S, BS 100 LE	4932336597	4002395311026
b. Pair of clamps for MILWAUKEE® belt sander.		4932459653	4058546028251



RANDOM ORBITAL SANDERS

Description	Diameter (mm)	Fits MILWAUKEE® random orbital sanders	Article Number	EAN Code
a. Base plate Ø 125 mm, 8 holes. Complete with rubber ring as spare	125	ROS 125 E	4932430091	4002395377527
a. Base plate Ø 150 mm, 6 holes. Complete with rubber ring as spare	150	TXE 150, ROS 150 E	4932357591	4002395343317
		ROS 150 E-2	4932430145	4002395378067
b. 75 mm sanding base for M12 FSDR75	75	M12 FSDR75	4932499472	4058546566364
c. 125 mm sanding base for M18 FROS125	125	M18 FROS125	4932500123	4058546572877
Clean Line System. Frame with dust bag	150	ROS 150	4931435911	4002395874729
Spare paper bags for 4932345544 (5pc)		TXE 150, TX 125, ROS 150 E	4931442873	4002395247882
d. Backind pad for M12 FUEL™ 150 mm random orbital sander - Soft and Hook & Loop	150	M12 FROS2.5, M12 FROS5	4932499244	4058546564087
e. Backind pad for M12 FUEL™ 150 mm random orbital sander - Hard and Hook & Loop	150	M12 FROS2.5, M12 FROS5	4932499245	4058546564094
f. Backind pad for M12 FUEL™ 150 mm random orbital sander - Soft and PSA	150	M12 FROS2.5, M12 FROS5	4932499246	4058546564100
g. Backind pad for M12 FUEL™ 150 mm random orbital sander - Hard and PSA	150	M12 FROS2.5, M12 FROS5	4932499247	4058546564117

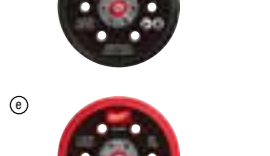

SYSTEM ATTACHMENT - SAWZALL™

	Description	Fits MILWAUKEE® SAWZALL™	Article Number	EAN Code
a.	Conversion kit: to convert FIXTEC™ blade reception models to keyed blade reception to accept 20 mm reception blades			
	Clamp		42680685	4058546073183
	Screw	SSE 1000 QX,SSPE 1000 QX,SSH 800 QX Hatch-et,PSH 18v hatchet,V18 SX,SSPE 1300 QX,M18 FUEL™ SAWZALL,USE 980 X,V28 SX,SSPE 1500 X	06832976	4058546069193
	Allen key 5/32"		49960070	045242221554
b.	Conversion kit: to convert FIXTEC™ blade reception models to keyed blade reception to accept 1/2" universal reception blades			
	Clamp		49225016	045242182060
	Screw	SSE 1000 QX,SSPE 1000 QX,SSH 800 QX Hatch-et,PSH 18v hatchet,V18 SX,SSPE 1300 QX,M18 FUEL™ SAWZALL,USE 980 X,V28 SX,SSPE 1500 X	06832976	4058546069193
	Allen key 5/32"		49960070	045242221554
c.	Pipe clamp	Fits to the current cordless FUEL™ SAWZALL™'s (FSZ, FSX)	4932478816	4058546360986



SYSTEM ATTACHMENTS - JIGSAWS

	Description	Article Number	EAN Code
a.	Gliding shoe for materials with delicate surfaces For HD18, BST18, JS120, JSPE 135, STEP 1200, JSPE90, FSPE 110, BSPE110, STEP800, ST800, V28 JSB	4932430356	4002395380176



SYSTEM ATTACHMENT - NAILERS

	Description	Article Number	EAN Code
a.	Extended magazine for M18 FUEL™ framing nailer (M18 FFN)	4932471605	4058546295042



SYSTEM ATTACHMENTS - DIE GRINDERS

	Description	Fits MILWAUKEE® die grinders	Article Number	EAN Code
a.	Ø 3 mm collet	DGL 34,DGL 30 E,DG 30 E,PSG 12,PSG 14.4 PP,HD18 SG	4932308974	4002395309092
	Ø 3 mm collet	M18 FDG	4932471202	4058546288303
	Ø 6 mm collet	PSG 14.4 PP,HD18 SG,PSG 12,DG 30 E,DGL 30 E,DGL 34	4932313192	4002395302833
	Ø 6 mm collet	DG 7 E	4931391453	4002395734818
	Ø 6 mm collet	DG 14-50 Q	48660978	045242155620
	Ø 8 mm collet	DGL 34,DGL 30 E,DG 30 E,PSG 12,PSG 14.4 PP,HD18 SG,V 28 SG	4932313190	4002395302840
	Ø 8 mm collet	DG 7 E	4931391452	4002395734801
	Ø 6.35 mm (1/4") collet	DGL 34,DGL 30 E,DG 30 E,PSG 12,PSG 14.4 PP,HD18 SG	4932313194	4002395302857
b.	Rubber Sleeve for M12 FDGA	M12 FDGA	4932478759	4058546360412



SYSTEM ATTACHMENTS - PLATE SHEARS

	Description	Fits MILWAUKEE® plate shears	Article Number	EAN Code
a.	Cutting table blade four sided blade	KS 2.5,S 2.5	4932430171	4002395378326
		PPS 12	4932308838	4002395309085
b.	Socket wrench 5/32"	SMC 1.2 Q	49960070	045242221554
c.	Replacement shear head assembly.	SMC 1.2 Q	48080500	045242089253

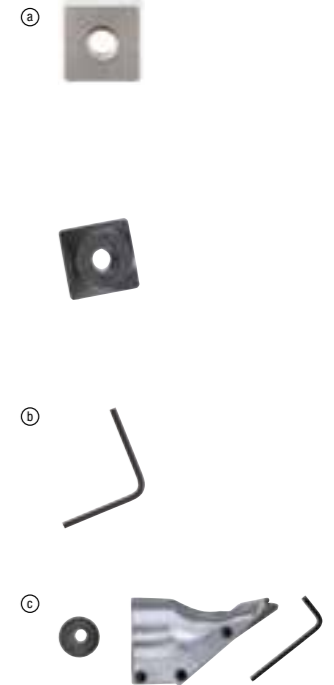

SYSTEM ATTACHMENTS - NIBBLERS

	Description	Fits nibblers	Article Number	EAN Code
a.	Punch	KN 2 PN 14.4,PN 12,N 2	4932430172	4002395378333
b.	Die	KN 2 PN 14.4,PN 12,N 2	4932279565	4002395308521
c.	Die and punch set for M12 FUEL™ sub compact 1.6 mm nibbler	KN 2 PN 14.4,PN 12,N 2	4932479353	4058546371470
d.	Die holder extension for M12 FUEL™ sub compact 1.6 mm nibbler	KN 2 PN 14.4,PN 12,N 2	4932479354	4058546371487



SYSTEM ATTACHMENTS - WALL CHASERS

- AUDD blade is a perfect solution for 80% of wall chaser applications
- - 30% less loading on the machine compared to the MILWAUKEE® DU blade
- - 40% higher speed of cut compared to the MILWAUKEE® DU blade
- ✓ Maximum performance ♦ Limited suitability - recommended for intermittent use

	a.	b.	c.
	HUDD	AUDD	DSU
Abrasive refractory materials	♦	✓	
Aerated and breeze concrete blocks	♦	✓	♦
Brick medium to soft	✓	✓	✓
Concrete medium	✓	✓	✓
Concrete reinforced with rebar	✓	♦	✓
Concrete with flint and rebar	♦	✓	
Fireclay	✓	✓	✓
General building materials	✓	✓	✓
Granite	✓		✓
Lime and sandstone blocks soft and abrasive	♦	✓	♦
Lime and sandstone blocks medium	✓	✓	
Screed	♦	✓	✓

	Description	Fits wall chasers	Article Number	EAN Code
a.	Two hole spanner straight	DME 30, DME 45, WCS 45, DME 65, WCE 65, WCE 30	4932367712	4002395338467
b.	T-handle key	WCE 30, WCS 45, WCE 65, DME 30, DME 45, DME 65	4931362928	4002395661879
c.	Dust protection grille against entry of ground particles	WCE 30, WCS 45, DME 30, DME 45	4932329397	4002395303892
d.	Dust protection grille against entry of ground particles	WCE 65, DME 65	4932326525	4002395303311
e.	Adaptor with bayonet fitting for direct connection of hose to machine	WCE 30, WCS 45, WCE 65, DME 30, DME 45, DME 65	4932362778	4002395334285
f.	Side handle	WCE 30, WCS 45, DME 30, DME 45	4932409546	4002395370870
g.	Flange nut	DME 1300	4932334667	4002395304448
h.	Clamping flange	DME 1300	4932334706	4002395304455
i.	Spacer set. Contents 6 rings		4931334675	4002395762804



SYSTEM ATTACHMENTS - SCREWDRIVERS

	Description	Fits MILWAUKEE® corded screwdrivers	Article Number	EAN Code
a.	Drywall sleeve assembly	DWE 4000 Q, DWSE 4000 Q, TKSE 2500 Q, 6790, 6743	49261036	045242185245
b.	Self drill sleeve assembly	TKSE 2500 Q, 6790	49261082	045242185375
	1/4" magnetic bit holder 76 mm	DWE 4000 Q, DWSE 4000 Q, 6743	48323065	045242128600
c.	Hex socket driver set (3pc)	TKSE 2500 Q, 6790, TQSE 1200 Q, TQSE 2500 Q, 6580, 6581	49663004	045242207848
	Ø 6 / 8 / 10 mm magnetic sockets			
d.	Collated attachment for M18 FSG		4933459202	4002395289974
e.	PH2 148 mm drywall screwdriving bit for M18 FSG		4932459393	4058546010546
f.	Mag / ring drywall bit holder 75 mm for M18 FSG		4932459394	4058546010553
g.	Offset attachment 1/4" hex M12FPDX		4932464481	4058546224264
h.	M12 FPDx-RAA Right angle attachment for drilling and screwdriving applications in confined spaces. 90° angle. 12 fixing positions. Direct bit reception.		4932464480	4058546224257
i.	13 mm Keyless chuck to suit M12 FPDx sub compact percussion drill		4932464479	4058546224240
j.	M12 BDDx-OA offset attachment for screwdriving applications - 12 fixing positions		4932430432	4002395380930
k.	M12 BDDx-RAA right angle attachment for drilling and screwdriving applications in confined spaces - 90° angle - 12 fixing positions - direct bit reception		4932430433	4002395380947
l.	Replacement chuck for M12 BDDx		4932430444	4002395381050
m.	Rivet tool nose set		48540100	045242504466
n.	152mm Nose extension kit- for M12™ rivet tool		48950100	045242504459
o.	M12 BDDx-OA offset attachment for screwdriving applications - 12 fixing positions		4932430432	4002395380930
p.	M12 BDDx-RAA right angle attachment for drilling and screwdriving applications in confined spaces - 90° angle - 12 fixing positions - direct bit reception		4932430433	4002395380947
q.	Extension nose piece for M18 FUEL™ rivet tool with ONE-KEY™		4932478962	4058546362447
r.	Jaw replacement set for M18 FUEL™ rivet tool with ONE-KEY™		4932479797	4058546375911

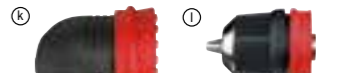
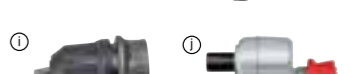
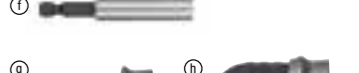

SIDE HANDLES

	Description	Article Number	EAN Code
a.	Side handle with depth gauge for all drills and percussion drills with gear neck diameter 43 mm	4932373725	4002395352647
b.	Side handle with depth gauge for all drills and percussion drills with a short gear neck (13 mm) of diameter 43 mm	4932364149	4002395342198



QUIK-LOK™ CABLES

	Cable length (m)	Country version	Article Number	EAN Code
a.	4	EU	4932373502	4002395351725
	4	CH	4932373504	4002395351749
	4	GB	4932373508	4002395351787
	6	EU	4932364483 ¹	4002395337620
b.	QUIK-LOK™ cable repair kit		4931380758	4002395714551

¹Heavy duty and acid resistant, non repairable

UNIVERSAL RIGHT ANGLE DRILL ATTACHMENT

- Converts MILWAUKEE® HDE 13 RQD straight drill to angle drill.
- Used extensively for drilling between joists or in tight corners.
- Head and handle swivel 360°.
- Provides two speeds: 1. Low: speed decreases by 30% torque increases by 50% 2. High: speed increases by 50%

	Description	Article Number	EAN Code
a.	Right angle drill attachment	48062871	045242088812



RUBBER SLEEVES FOR IMPACT WRENCHES

	Description	Article Number	EAN Code
a.	Rubber sleeve for M18 ONEFIW2FC12	4932498145	4058546513054
b.	Rubber sleeve for M18 ONEFMTIW2FC12	4932498144	4058546513047
c.	Rubber sleeve for M18 ONEFHIWF1	4932478760	4058546360429
d.	Rubber sleeve for M18 ONEFHIWF1	4932479975	4058546377694
e.	Rubber sleeve for M18 FHIWF12, M18 ONEFHIWF12 & M18 ONEFHIWF34	49162767	045242506422
f.	Rubber sleeve for M18 FHIWP12 & M18 ONEFHIWP12	49162766	045242506415
g.	Rubber sleeve for M18 FHIW2F12	4932493560	4058546484316
h.	Rubber sleeve for M18 FHIW2P12	4932493581	4058546484521
i.	Rubber sleeve for M18 FW2F & M18 FW2P	4932478770	4058546360528
j.	Rubber sleeve for M18 FMTIW2F & M18 FMTIW2P	4932478771	4058546360535
k.	Rubber sleeve for M18 FMTIWP	49162861	045242510146
l.	Rubber sleeve for M18 CHIW and M28 CHIW	49162763	045242324255
m.	Rubber sleeve for M18 CIW	49162754	045242320455
n.	Rubber sleeve for M12 FIWF	4932478758	4058546360405
	Rubber sleeve for M12 FUJEL™ sub-compact impact wrenches	4932500130	4058546572945
p.	Rubber sleeve for M12 FRAIWF38 & M12 FRAWF12	4932479098	4058546368920
o.	Rubber sleeve for M12 FIR38	4932479100	4058546368944
q.	Rubber sleeve for M12 FID	4932479102	4058546368968
r.	Rubber sleeve for M12 FID2	4932479977	4058546377717
s.	Rubber sleeve for M18 FID2	4932479103	4058546368975
t.	Rubber sleeve for M18 FID3	4932479974	4058546377687



SYSTEM ATTACHMENTS - ROTARY HAMMERS

ROTARY HAMMERS CHUCK ADAPTORS

	Description	Reception	Tool drive	Only suitable for	Article Number	EAN Code
a.	FIXTEC - SDS-Plus	SDS-Plus	FIXTEC	-	4932379877	4002395346561
b.	FIXTEC - SDS-Plus	SDS-Plus	FIXTEC	BH 26 LXE, PLH 16 QEX, V28 HX, V18 HX, PLH 26 QEX, PH 30 POWER X	4932399152	4002395357628
c.	FIXTEC - SDS-Plus	SDS-Plus	FIXTEC	PH 26 X, KH24 XE, KH 26 XE, KH 28 SUPER XE.	4932352299	4002395369584
d.	FIXTEC - 1/2" x 20 UNF 1	1/2" x 20 UNF	FIXTEC	PH 26 X, KH 24 XE, KH 24 XE, KH 26 XE, KH 28 Super XE.	4932371807	4002395344710
e.	FIXTEC - 1/2" x 20 UNF 2	1/2" x 20 UNF	FIXTEC	PLH 16 QEX, V 28 HX, V 18 HX, PLH 26 QEX, PH 30 Power X, KH 26 XE, KH 24 XE, KH 28 Super XE, BH 26 LXE and PH 26 X.	4932399154	4002395357635
f.	SDS-plus - 1/2" x 20 UNF 1. Chuck adaptor with direct bit reception (1/4" Hex) to accept screwdriving bits. Threaded housing enables adaptor to be tightened to the chuck resulting in no wobble	1/2" x 20 UNF	SDS-Plus	-	4932367438	4002395337668
g.	SDS-plus - 1/2" x 20 UNF 1. Chuck adaptor with retaining screw	1/2" x 20 UNF	SDS-Plus	-	4932367166	4002395334438

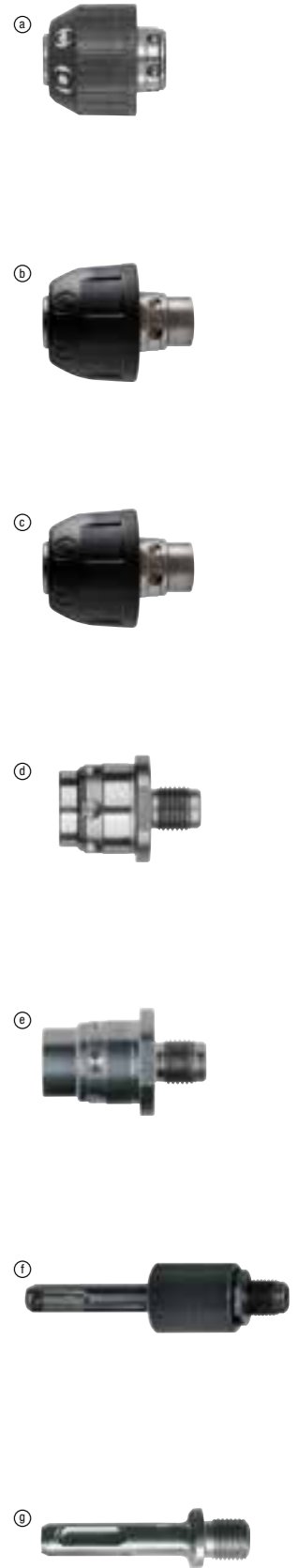

KEYED CHUCKS

	Chuck jaws open (mm)	Drill reception	Locking device	Safety screw	Rotary drill	Percussion drill	Battery drill	Chuck key	Article Number	EAN Code
a.	1.5-13	1/2" x 20		✓	✓	✓	✓	A	4932267980	4002395300488
b.	3.0-16	Taper B16			✓			C	4932127010	4002395306169
c.	3.0-16	M18x2.5	✓	✓	✓	✓		C	4932320014	4002395310784

KEYED CHUCKS - MACHINE SPECIFIC

	Chuck jaws open (mm)	Drill reception	Fits MILWAUKEE® drill drivers	Safety screw	Chuck key	Article Number	EAN Code
a.	1.0-10	3/8" x 24	HDE 6 RQ	✓	H	48660817	045242155705

KEYED CHUCKS WITH 1/4" HEX RECEPTION

	Chuck jaws open (mm)	Drill reception	Battery drill	Chuck key	Article Number	EAN Code
a.	1.0-10	1/4" Hex	✓	A	4932314867	4002395300112

CHUCK KEYS

	Description	Type	Ref. No.	Article Number	EAN Code
a	Chuck key	A	S2A	4932221378	4002395302765
		B	S2AT	4932310612	4002395309177
		C	S3T	4932221379	4002395306381
		D	S14	4932304684	4002395300105
		E	S4	4932221380	4002395306398
		G	S2	4932319995	4002395303724
		H		48663350	045242157600
		J		48663240	045242157501
		K		48663280	045242157556
		b	Morse taper No. 3 adaptor for chucks with B16 taper	MT3 - B16	
c.	Ejector tool DIN 317 size 3			4932604226	4002395311248

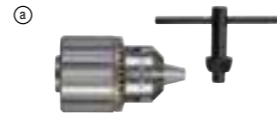

KEYLESS CHUCKS 2 SLEEVES

	Chuck jaws open (mm)	Reception	Locking device	Safety screw	Rotary drill	Percussion drill	Battery drill	Article Number	EAN Code
a.	1.0-10	3/8" x 24		✓	✓		✓	4932349457	4002395318155
b.	1.0-10	1/2" x 20	✓	✓	✓	✓	✓	4932364382	4002395337675
c.	1.5-13	1/2" x 20	✓		✓	✓	✓	4932376531	4002395346332
d.	1.5-13	1/2" x 20	✓	✓	✓	✓	✓	4932376533	4002395346349
e.	1.5-13	1/2" x 20	✓		✓	✓	✓	4932364265 ¹	4002395334056
f.	1.5-13	1/2" x 20	✓	✓	✓	✓	✓	4932364267	4002395334070

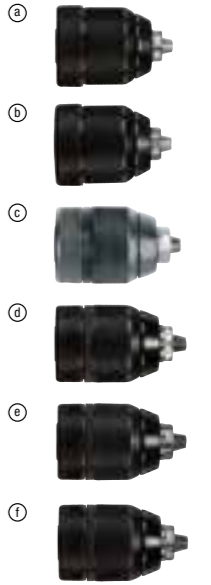

KEYLESS CHUCKS FOR FIXTEC (SPINDLE LOCK) MACHINES

	Chuck jaws open (mm)	Reception	Locking device	Safety screw	Rotary drill	Percussion drill	Battery drill	Article Number	EAN Code
a.	1.0-10	3/8" x 24	✓	✓	✓	✓	✓	4932371018	4002395339365
b.	1.0-10	1/2" x 20	✓	✓	✓	✓	✓	4932372443	4002395345458
c.	1.5-13	1/2" x 20	✓	✓	✓	✓	✓	4932371913	4002395345366
d.	1.5-13	9/16" x 18	✓	✓	✓	✓	✓	4932478806 ¹	4058546360887



INDUSTRIAL KEYLESS CHUCKS FOR CORDED PERCUSSION DRILLS

	Chuck jaws open (mm)	Reception	Locking device	Rotary drill	Percussion drill	Battery drill	Article Number	EAN Code
a.	1.0-13	1/2" x 20	✓	✓	✓		4932364266	4002395334063



KEYLESS CHUCKS - SPECIFIC TOOL RELATED CHUCKS

	Chuck jaws open (mm)	Reception	Machine specific	Locking device	Rotary drill	Safety screw	Article Number	EAN Code
a.	1.0-10	1/2" x 20	HDE 10 RQX			✓	48661520	045242156795
b.	1.5-13	1/2" x 20	HDE 13 RQX			✓	42660755	4002395891436
c.	1.0-10	FIXTEC	M12 BDDX		✓		4932430444	4002395381050



SYSTEM ATTACHMENTS - ANGLE GRINDERS

	Description	Fits 115 mm angle grinders	Fits 125 mm angle grinders	Fits 150mm angle grinders	Fits 180mm angle grinders	Fits 230mm angle grinders	Article Number	EAN Code
a.	Flange nut M14	✓	✓	✓	✓	✓	4932345628	4002395313105
b.	Backing flange	✓	✓	✓	✓	✓	4932449324	4002395245185
c.	Two hole spanner straight	✓	✓	✓	✓	✓	4932367712	4002395338467
d.	Open-ended spanner. SW 17/24	✓	✓	✓	✓	✓	4932345710	4002395307722
e.	Cranked two hole spanner for steel wire brushes				✓	✓	4932371469	4002395342181
f.	Dust protection grille against entry of ground particles		✓	✓			4932329397	4002395303892
	Side handle	✓	✓	✓			4932409546	4002395370870
g.	Anti-Vibration side handle	✓	✓	✓	✓		4932399991	4002395366507
	Hand protection guard				✓	✓	4932399992	4002395366514
	Flange nut set. Only for AGV 16- 180 QXC					Suitable for WS 2300 (Australia version)	4932351632	4002395321636
	Flange nut M14 (4932345629), backing flange (4932371404), large flange nut (4932367952)							

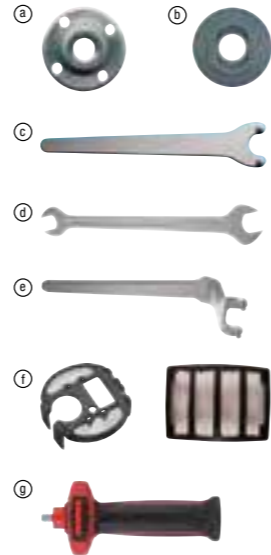

FLEXIBLE BACKING PADS

	Description	Bore size (mm)	Diameter (mm)	Fits 115 mm angle grinders	Fits 125 mm angle grinders	Fits 180mm angle grinders	Fits 230mm angle grinders	Article Number	EAN Code
a.	Flexible backing pad 110x14.2mm	14.2	110	✓				4932345760	4002395313488
		14.2	125		✓			4932345761	4002395313495
		14.2	170			✓		4932345758	4002395313501
		22.2	170			✓		4932352744	4002395374021
b.	Flange nut M14			✓	✓	✓	✓	4932345627	4002395313112



CUTTING AND GRINDING DUST EXTRACTION

	Description	Fits 115 mm angle grinders	Fits 125 mm angle grinders	Fits 180mm angle grinders	Fits 230mm angle grinders	Article Number	EAN Code
a.	Dust guard for cutting - DSG125. 100% tool-free connection to 115 & 125mm AG(V) 12 and AGV 15 series. Does not fit AGVs equipped with autobalancer. Key less depth adjustment from 5 - 28 mm. Solid steel cutting guide to prevent twisting during cutting and flexible cutting line indicator for plunge cuts. Dust guard fits the MILWAUKEE® M-class cleaners with unique "click-system" adapter supplied with the vacuum cleaner.	✓	✓			4932499768	4058546569327
b.	Dust guard for grinding - DSG125. 100% tool-free connection to 115 & 125 mm AG(V) 12 and AGV 15 series. Does not fit AGVs equipped with autobalancer. Tool-free front sliding function to allow access to corners and surfacing to edges. Dust guard fits the MILWAUKEE® M-class cleaners with unique "click-system" adapter supplied with the vacuum cleaner.	✓	✓			4932499769	4058546569334
c.	Dust guard for grinding - DSG180. 100% tool-free connection to 180 -230mm AG21, AGV22, AG24, AGVK24, and FUEL™ grinders. Does not fit LAGs equipped with autobalancer. Tool-free front sliding function to allow access to corners and surfacing to edges. Dust guard fits the MILWAUKEE® M-class cleaners with unique "click-system" adapter supplied with the vacuum cleaner.			✓		4932499770	4058546569341
	Dust guard for cutting - DEC 230. 100% tool free connection to Ø180 - 230 mm AG 22, keyless depth adjustment from 5 - 60 mm. Solid steel cutting guide to prevent twisting during cutting and flexible cutting line indicator for plunge cuts. Dust guard fits to the MILWAUKEE® M-Class cleaners with unique "click-system" adaptor supplied with the vacuum cleaner.			✓	✓	4932459340	4058546010010
d.	Dust guard for cutting - DEC 230 K. 100% tool free connection to Ø180 - 230 mm AG21, AGV 22, AG 24, AGVK 24 and FUEL™ grinders. Does not fit to LAG's equipped with autobalancer. Keyless depth adjustment from 5 - 60 mm. Solid steel cutting guide to prevent twisting during cutting and flexible cutting line indicator for plunge cuts. Dust guard fits to the MILWAUKEE® M-Class cleaners with unique "click-system" adaptor supplied with the vacuum cleaner.			✓	✓	4932459341	4058546010027



SYSTEM ATTACHMENTS - BANDSAWS

- Safety - Protects user from injuries by preventing any access to the blade
- Jobsite Armor™ durability - Proprietary composite material and crush zone barriers absorb impacts and protect the tool
- Protection from debris - Covers protect the blade track and the pulley wheels from debris entering the tool and affecting overall performance
- Tool-free installation and removal within second
- Extends life of blade by protecting it from external objects

BANDSAW COVERS

	Description	Article Number	EAN Code
a.	Bandsaw Cover for HD18 BS	4932471458	4058546290863
b.	Bandsaw Cover for M18 FBS85	4932472241	4058546326371

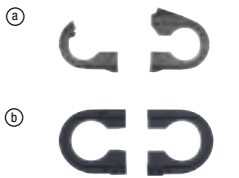

SYSTEM ATTACHMENTS - CIRCULAR SAWS

	Description	Fits MILWAUKEE® circular saws	Article Number	EAN Code
a.	Dust absorption connector.	PCS 55	4932369282	4002395338412
b.	Spanner for removing saw blade.	CS 55,HK 46 N,SCS 65 Q,CS 75,PCS 55,HKS 75,HK 75 A,HKS 85,PMS 18	4932371469	4002395342181
c.	Parallel guide / fence	SCS 65 Q	49224146	045242181896
d.	Dust extraction hood for mitre saw, includes long hose, short hose, five lock fittings, 2x universal adaptors, extractor hose	MS 216 SB,M18 SMS216	4932430005	4002395376667



GUIDE RAILS AND ATTACHMENTS

	Description	Features	Article Number	EAN Code
a.	PSA-1 Guide rail clamps	Guide rail clamps compatible with GR 800, GR 1400 and GR 2700 guide rails	4932479068	4058546368623
b.	PSA-2 Guide rail joining bars	Guide rail joining bars for GR 800, GR 1400 and GR 2700 guide rails	4932479069	4058546368630
c.	PSA-3 Replacement guide rail splinter strip	Replacement guide rail splinter strip for GR 800, GR 1400 and GR 2700	4932479070	4058546368647
d.	PSA-4 Guide rail bag	Guide rail bag for GR 800 and GR 1400	4932479071	4058546368654
e.	PSA-5 Replacement low friction strip	Replacement low friction strip for GR 800, GR 1400 and GR 2700	4932479072	4058546368661
f.	GR 2700 2.7 m aluminium guide rail	Compatible with M18 FPS55, M18 FCSG66, M18 FMCS66, CS85 CBE, M18 FCS66GR3, M18 FR12, M18 FTR, M18 FTR8	4932479067	4058546368616
g.	GR 1400 1.4 m aluminium guide rail	Compatible with M18 FPS55, M18 FCSG66, M18 FMCS66, CS85 CBE, M18 FCS66GR3, M18 FR12, M18 FTR, M18 FTR8	4932479066	4058546368609
h.	GR 800 0.8 m aluminium guide rail	Compatible with M18 FPS55, M18 FCSG66, M18 FMCS66, CS85 CBE, M18 FCS66GR3, M18 FR12, M18 FTR, M18 FTR8	4932479065	4058546368593
i.	GR-KIT 1400 mm guiderails kit	2 x 1400 mm guiderails, supplied with bag and joining bars. Compatible with M18 FPS55, M18 FCSG66, M18 FMCS66, CS85 CBE, M18 FCS66GR3, M18 FR12, M18 FTR, M18 FTR8	4932480906	4058546411916
j.	GA-165 Guiderail adaptor for M18 FUEL™ 165 mm deep cut circular saw	Allows the M18 FCSDC165 circular saw to be used on all MILWAUKEE® guiderails	4932500003	4058546571672

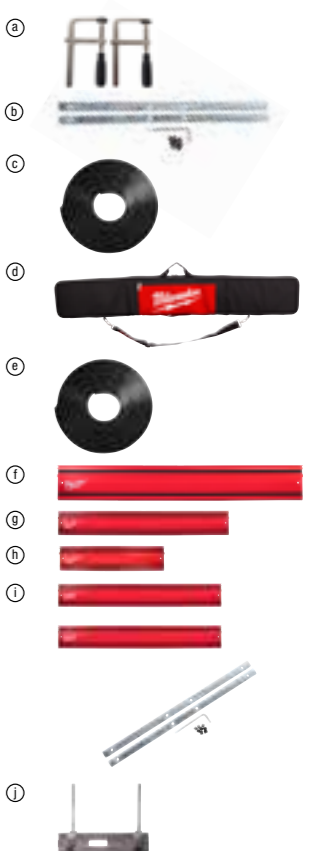

SYSTEM ATTACHMENTS - PLANERS

	Description	All planers 82 & 102mm	Article Number	EAN Code
a.	Parallel guide	✓	4932274071*	4002395300358
	Folding rebate depth gauge. For all planers except H500 / PR 1.6-82 models	✓	4932274069	4002395300129



SYSTEM ATTACHMENTS - OUTDOOR PRODUCTS

SYSTEM ATTACHMENTS - CHAINSAWS

		Chain bar length (cm)	Chain gauge (mm/)	Chain pitch (mm/)	Fits MILWAUKEE® chain saws	Article Number	EAN Code	
a.	Chainsaw Chains	15 cm/ 6" Saw Chain 3/8" x 1.1mm	15	1.1/ 0.043	9.5/ 3/8	M12 FHS	4932478427	4058546346188
		20 cm/ 8" Saw Chain 3/8" x 1.1mm	20	1.1/ 0.043	9.5/ 3/8	M18 FHS20	4932480176	4058546404611
		25 cm/ 10" Saw Chain 3/8" x 1.1mm	25	1.1/ 0.043	9.5/ 3/8	M18 FOPH-CSA	4932471329	4058546289577
		30 cm/ 12" Saw Chain 0.325" x 1.1mm	30	1.1/ 0.043	8.3/ .325	M18 FTHCHS30, M18 FTSP30	4932480177	4058546404628
		30 cm/ 12" Saw Chain 3/8" x 1.1mm	30	1.1/ 0.043	9.5/ 3/8	M18 FCHSC	4932471385	4058546290139
		35 cm/ 14" Saw Chain 0.325" x 1.1mm	35	1.1/ 0.043	8.3/ .325	M18 FTHCHS35	4932480178	4058546404635
		35 cm/ 14" Saw Chain 3/8" x 1.1mm	35	1.1/ 0.043	9.5/ 3/8	M18 FCHS35	4932479820	4058546376147
		40 cm/ 16" Saw Chain 3/8" x 1.1mm	40	1.1/ 0.043	9.5/ 3/8	M18 FCHS	4932464873	4058546228187
		40 cm/ 16" Saw Chain 0.325" x 1.3mm	40	1.3/ 0.050	8.3/ .325	M18 F2CHS50	4932500577	4058546618797
		50 cm/ 20" Saw Chain 0.325" x 1.3mm	50	1.3/ 0.050	8.3/ .325	M18 F2CHS50	4932498791	4058546526603
b.	Chainsaw guide bars	15 cm/ 6" Guide Bar 3/8" x 1.1mm	15	1.1/ 0.043	9.5/ 3/8	M12 FHS	4932480168	4058546404536
		20 cm/ 8" Guide Bar 3/8" x 1.1mm	20	1.1/ 0.043	9.5/ 3/8	M18 FHS20	4932480169	4058546404543
		25 cm/ 10" Guide Bar 3/8" x 1.1mm	25	1.1/ 0.043	9.5/ 3/8	M18 FOPH-CSA	4932480170	4058546404550
		30 cm/ 12" Guide Bar 0.325" x 1.1mm	30	1.1/ 0.043	8.3/ .325	M18 FTHCHS30, M18 FTSP30	4932480171	4058546404567
		35 cm/ 14" Guide Bar 3/8" x 1.1mm	35	1.1/ 0.043	9.5/ 3/8	M18 FCHS35	4932480172	4058546404574
		35 cm/ 14" Guide Bar 0.325" x 1.1mm	35	1.1/ 0.043	8.3/ .325	M18 FTHCHS35	4932480173	4058546404581
		40 cm/ 16" Guide Bar 3/8" x 1.1mm	40	1.1/ 0.043	9.5 / 3/8	M18 FCHS	4932480174	4058546404598
		40 cm/ 16" Guide Bar 0.325" x 1.3mm	40	1.3/ 0.050	8.3/ .325	M18 F2CHS50	4932500578	4058546618803
	50 cm/ 20" Guide Bar 0.325" x 1.3mm	50	1.3/ 0.050	8.3/ .325	M18 F2CHS50	4932498790	4058546526597	
c.	Chainsaw bag for M18™ rear handle chainsaws	-	-	-	-	4932493810	4058546509705	
d.	Chainsaw bag for M18™/M12™ hatchet pruning saws	-	-	-	-	4932493811	4058546509712	



SYSTEM ATTACHMENTS - LINE TRIMMERS

		Article Number	EAN Code
a.	Double shoulder harness for brush cutters	4932492849	4058546477202
b.	Single shoulder strap for line trimmers	4932492671	4058546475420
c.	2 mm x 45 m trimmer line	49162712	045242493906
d.	2.4 mm x 76 m trimmer line	49162713	045242493913
e.	Brush cutter replacement blade 4-tooth for M18 FOPH-BCA	4932481041	4058546413262
f.	Brush cutter replacement blade- 3-tooth for M18 F2BCU	4932498762	4058546526313
g.	Easy load trimmer head Gen II	4932480180	4058546404659



SYSTEM ATTACHMENTS - MOWERS

		Article Number	EAN Code
a.	Mower blade 187/ 46 cm	4932492106	4058546414733
	Mower blade 217/ 53 cm	4932479818	4058546376123
b.	High performance mower blade 187/ 46 cm	4932492107	4058546414740
	High performance mower blade 217/ 53 cm	4932479819	4058546376130
c.	Lawn mower cover 217/ 53 cm	4932479821	4058546376154



SYSTEM ATTACHMENTS - BLOWERS

		Article Number	EAN Code
a.	Single shoulder strap for M18 F2BL	4932492418	4058546417857
b.	Angled flare attachment for blowers	4932498513	4058546523824
c.	Blower nozzle attachment kit for blowers	4932498514	4058546523831
d.	Gutter attachment for handheld blowers	4932498512	4058546523817



SYSTEM ATTACHMENTS - OTHER OUTDOOR PRODUCTS

		Article Number	EAN Code
a.	Edger blade 203 mm	4932471330	4058546289584
b.	Holster for M12™ brushless pruning shear	4932492430	4058546417970
c.	Replacement blade for M12™ brushless pruning shear	4932492431	4058546417987
d.	Replacement blade for M18 BLTS	4932493557	4058546484286
e.	Bristle brush replacement drums for M18 FOPH	4932499150	4058546530198
f.	Rubber broom replacement drums for M18 FOPH	4932499151	4058546530204
g.	3.7 l tank for M12™ handheld chemical sprayer 3.7 l	4932500238	4058546615406



CRIMPING DIES

Type	Form	Cable lug size (mm ²)	Imprint code	M18 HCCT, M18 ONEHCCT60			M18 HCCT109/42		
				Description	Article Number	EAN Code	Description	Article Number	EAN Code
a. DIN 46235 for copper compression cable lugs and connectors (DIN 46267)	Hex	6	5	DN22 Cu 6	4932464861	4058546228064	-	-	-
		10	6	DN22 Cu 10	4932464862	4058546228071	-	-	-
		16	8	DIN22 Cu 16	4932451744	4002395277551	DIN13 Cu 16	4932459465	4058546011260
		25	10	DIN22 Cu 25	4932451745	4002395277568	DIN13 Cu 25	4932459466	4058546011277
		35	12	DIN22 Cu 35	4932451746	4002395277575	DIN13 Cu 35	4932459467	4058546011284
		50	14	DIN22 Cu 50	4932451747	4002395277582	DIN13 Cu 50	4932459468	4058546011291
		70	16	DIN22 Cu 70	4932451748	4002395277599	DIN13 Cu 70	4932459469	4058546011307
		95	18	DIN22 Cu 95	4932451749	4002395278206	DIN13 Cu 95	4932459470	4058546011314
		120	20	DIN22 Cu 120	4932451750	4002395278213	DIN13 Cu 120	4932459471	4058546011321
		150	22	DIN22 Cu 150	4932451751	4002395278220	DIN13 Cu 150	4932459472	4058546011338
		185	25	DIN22 Cu 185	4932451752	4002395278227	DIN13 Cu 185	4932459473	4058546011345
		240	28	DIN22 Cu 240	4932451753	4002395278234	DIN13 Cu 240	4932459474	4058546011352
		300	32	DIN22 Cu 300	4932451754	4002395278251	DIN13 Cu 300	4932459475	4058546011369



Type	Form	Cable lug size (mm ²)	Imprint code	M18 HCCT, M18 ONEHCCT60			M18 HCCT109/42		
				Description	Article Number	EAN Code	Description	Article Number	EAN Code
a. Tubular cable lugs and connectors	Hex	6	6	R22 Cu 6	4932479391	4058546371852	-	-	-
		10	10	R22 Cu 10	4932479392	4058546371869	-	-	-
		16	16	R22 Cu 16	4932451755	4002395278268	R13 Cu 16	4932459494	4058546011550
		25	25	R22 Cu 25	4932451756	4002395278275	R13 Cu 25	4932459495	4058546011567
		35	35	R22 Cu 35	4932451757	4002395278282	R13 Cu 35	4932459496	4058546011574
		50	50	R22 Cu 50	4932451758	4002395278289	R13 Cu 50	4932459497	4058546011581
		70	70	R22 Cu 70	4932451759	4002395278296	R13 Cu 70	4932459498	4058546011588
		95	95	R22 Cu 95	4932451760	4002395278303	R13 Cu 95	4932459499	4058546011595
		120	120	R22 Cu 120	4932451761	4002395278310	R13 Cu 120	4932459500	4058546011602
		150	150	R22 Cu 150	4932451762	4002395278317	R13 Cu 150	4932459501	4058546011609
		185	185	R22 Cu 185	4932451763	4002395278324	R13 Cu 185	4932459502	4058546011616
		240	240	R22 Cu 240	4932451764	4002395278331	R13 Cu 240	4932459503	4058546011623
		300	300	R22 Cu 300	4932451765	4002395278338	R13 Cu 300	4932459504	4058546026769
400	400	-	-	-	R13 Cu 400	4932459505	4058546026776		



Type	Form	Cable lug size (mm ²)	Imprint code	M18 HCCT, M18 ONEHCCT60			M18 HCCT109/42		
				Description	Article Number	EAN Code	Description	Article Number	EAN Code
a. KRF Lugs for copper compression cable lugs and connectors (Nordic Series)	Hex	10	-	R22 OU/KRF 10	4932479378	4058546371722	-	-	-
		16	-	R22 OU/KRF 16	4932479379	4058546371739	-	-	-
		25	-	R22 OU/KRF 25	4932479380	4058546371746	-	-	-
		35	-	R22 OU/KRF 35	4932479381	4058546371753	-	-	-
		50	-	R22 OU/KRF 50	4932479382	4058546371760	-	-	-
		70	-	R22 OU/KRF 70	4932479383	4058546371767	-	-	-
		95	-	R22 OU/KRF 95	4932479384	4058546371774	-	-	-
		120	-	R22 OU/KRF 120	4932479385	4058546371781	-	-	-
		150	-	R22 OU/KRF 150	4932479386	4058546371788	-	-	-
		185	-	R22 OU/KRF 185	4932479387	4058546371795	-	-	-
		240	-	R22 OU/KRF 240	4932479388	4058546371802	-	-	-
		300	-	R22 OU/KRF 300	4932479389	4058546371809	-	-	-



Type	Form	Cable lug size (mm ²)	Imprint code	M18 HCCT, M18 ONEHCCT60			M18 HCCT109/42		
				Description	Article Number	EAN Code	Description	Article Number	EAN Code
a. NF C 20-130 for copper compression cable lugs	Hex	16	16	NF22 Cu 16	4932451733	4002395276837	NF13 Cu 16	4932459453	4058546011147
		25	25	NF22 Cu 25	4932451734	4002395276844	NF13 Cu 25	4932459454	4058546011154
		35	35	NF22 Cu 35	4932451735	4002395276851	NF13 Cu 35	4932459455	4058546011161
		50	50	NF22 Cu 50	4932451736	4002395276858	NF13 Cu 50	4932459456	4058546011168
		70	70	NF22 Cu 70	4932451737	4002395276865	NF13 Cu 70	4932459457	4058546011175
		95	95	NF22 Cu 95	4932451738	4002395276872	NF13 Cu 95	4932459458	4058546011182
		120	120	NF22 Cu 120	4932451739	4002395276879	NF13 Cu 120	4932459459	4058546011189
		150	150	NF22 Cu 150	4932451740	4002395276886	NF13 Cu 150	4932459460	4058546011196
		185	185	NF22 Cu 185	4932451741	4002395276893	NF13 Cu 185	4932459461	4058546011203
		240	240	NF22 Cu 240	4932451742	4002395276900	NF13 Cu 240	4932459462	4058546011210
		300	300	NF22 Cu 300	4932451743	4002395276907	NF13 Cu 300	4932459463	4058546011217
		400	400	-	-	-	NF13 Cu 400	4932459464	4058546011224



Type	Form	Cable lug size (mm ²)	Imprint code	M18 HCCT, M18 ONEHCCT60			M18 HCCT109/42		
				Description	Article Number	EAN Code	Description	Article Number	EAN Code
a. Alu Cuivre (9 mm crimp) NFC 63-061-B	Hex	35/ 50	E140	NF22 E140	4932479394	4058546371883	NF13 E140-2x9	4932479686	4058546374808
		70/ 95/ 120	E173	NF22 E173	4932479395	4058546371890	NF13 E173-2x9	4932479687	4058546374815
		150/ 185/ 240	E235	NF22 E235	4932479396	4058546371906	NF13 E235-2x9	4932479688	4058546374822
		300	E260	NF22 E260	4932479397	4058546371913	NF13 E260-2x9	4932479689	4058546374829
		6 - 35	E140	NF22 E140	4932479394	4058546371883	NF13 E140-2x9	4932479686	4058546374808
		25 - 70	E173	NF22 E173	4932479395	4058546371890	NF13 E173-2x9	4932479687	4058546374815
		150	E215	NF22 E215	4932479398	4058546371920	NF13 E215-9	4932479690	4058546374846
		185 - 240	E280	-	-	-	NF13 E280-9	4932479691	4058546374853
		7.07	E54	NF22 E54	4932479399	4058546371937	NF13 E54-10	4932479692	4058546374860
		9.6/ 10.8/ 12.56	E68	NF22 E68	4932479400	4058546371944	NF13 E68-18	4932479693	4058546374867
		12.4/ 14.1/ 15.9/ 19.6	E72	NF22 E72	4932479401	4058546371951	NF13 E72-10	4932479694	4058546374874
		17.8/ 22/ 27.6	E83	NF22 E83	4932479402	4058546371958	NF13 E83-18	4932479695	4058546374881
		28.25/ 29.3/ 38.2/ 38.46	E100	NF22 E100	4932479403	4058546371965	NF13 E100-18	4932479696	4058546374888
48.3	E120	NF22 E120	4932479404	4058546371972	NF13 E120-18	4932479697	4058546374895		
70/ 95/ 120	E173	NF22 E173	4932479395	4058546371890	NF13 E173-2x9	4932479687	4058546374815		
116/ 146	E215	-	-	-	NF13 E215-18	4932479698	4058546374922		
22	E100	-	-	-	NF13 E100-18	4932479696	4058546374907		
34.4	E120	-	-	-	NF13 E120-18	4932479697	4058546374914		
43.1/ 54.6	E140	-	-	-	NF13 E140-2x9	4932479686	4058546374808		
75.5/ 93.3	E173	-	-	-	NF13 E173-2x9	4932479687	4058546374815		
117	E210	-	-	-	NF13 E210-10	4932479699	4058546374938		
148	E230	-	-	-	NF13 E230-10	4932479700	4058546374945		
228	E280	-	-	-	NF13 E280-5	4932479701	4058546374952		
17.8/ 22/ 27.8/ 34.4	E120	-	-	-	NF13 E120-18	4932479697	4058546374914		
37.7/ 43.1/ 54.6	E140	-	-	-	NF13 E140-2x9	4932479686	4058546374808		
58.9/ 80/ 69.3/ 88	E173	-	-	-	NF13 E173-2x9	4932479687	4058546374815		
59.7/ 116.2	E210	-	-	-	NF13 E210-10	4932479699	4058546374938		
75.7/ 147.1	E230	-	-	-	NF13 E230-10	4932479700	4058546374945		
17.8/ 22/ 27.8/ 34.4/ 43.1	E54	-	-	-	NF13 E54-10	4932479692	4058546374860		
37.7/ 54.6/ 69.3/ 88	E72	-	-	-	NF13 E72-10	4932479694	4058546374874		
58.9/ 80	E100	-	-	-	NF13 E100-10	4932479702	4058546374969		
59.7/ 116.2/ 75.5/ 147.1	E120	-	-	-	NF13 E120-9	4932479703	4058546374976		



Type	Form	Cable lug size (mm ²)	Imprint code	M18 HCCT, M18 ONEHCCT60			M18 HCCT109/42		
				Description	Article Number	EAN Code	Description	Article Number	EAN Code
a. Copper solderless terminals (DIN 46234, DIN 46230, DIN 46341)	Half round indent	16	16	Q22 CU 16	4932451766	4002395278978	Q13 CU 16	4932459477	4058546011383
		25	25	Q22 CU 25	4932451767	4002395278985	Q13 CU 25	4932459478	4058546011390
		35	35	Q22 CU 35	4932451768	4002395278992	Q13 CU 35	4932459479	4058546011406
		50	50	Q22 CU 50	4932451769	4002395279009	Q13 CU 50	4932459480	4058546011413
		70	70	Q22 CU 70	4932451770	4002395279016	Q13 CU 70	4932459481	4058546011420
		95	95	-	-	-	Q13 CU 95	4932459482	4058546011437



Type	Form	Cable lug size (mm ²)	Imprint code	M18 HCCT, M18 ONEHCCT60			M18 HCCT109/42		
				Description	Article Number	EAN Code	Description	Article Number	EAN Code
a. DIN Aluminium for aluminium compression cable lugs and connectors (DIN 46329, 46267 Part 1 and 2, DIN EN 50182)	Hex	10	10	DIN22 AL 10	4932479390	4058546371845	-	-	-
		16/25	12	DIN22 AL 16/25					

SYSTEM ATTACHMENTS - PIPE CUTTERS

	Description	Article Number	EAN Code
a	Pipe cutter wheels. Suitable for copper pipe. Not suitable for plastic or stainless steel pipe	48380010	045242159710
b	Cable cutter blade for C12 PC	4932430070	4002395377312
c	PEX cutter blade for C12 PPC	4931441978	4002395179268
d	Wheels for M12™ RAPTOR pipe cutter stainless steel (M12 PCSS) (2pc)	4932479243	4058546370374
e	Wheels for M12™ RAPTORXL pipe cutter stainless steel (M12 PCCS54)	4932498665	4058546525347
f	Blade for M18 FUEL™ steel pipe cutter	4932500399	4058546617011
g	Stripping head 12-19 mm	4932499277	4058546564414



SYSTEM ATTACHMENTS - CABLE CUTTERS

	Description	Features	Article Number	EAN Code
a.	ACSR Aluminium steel reinforced cable cutting jaw including blades	Cable cutter jaw and blade set for cutting aluminium-steel transmission cable. ACSS-aluminium conductor steel supported cable and ACSR-aluminium conductor steel reinforced cable i.e. 94-AL1 / 15-ST1A (EN 50182). Not suitable for armoured cable or steel rods. Max. cutting Ø22.5 mm	49162773	045242350070
	ACSR Aluminium steel reinforced cable cutting blades	Replacement cable cutter blades for ACSR-jaw. Not suitable for armoured cable or steel rods.	48440412	045242355235
b.	Cu/Al standard copper & aluminium cable cutting jaw including blades	Cable cutter jaw and blade set for cutting copper/aluminium. Copper/aluminium standard stranded cable up to 4 x 50 mm ² , 1 x 500 mm ² in aluminium and 1 x 400 mm ² in copper. Not suitable for fine stranded/highly flexible cable. Max. cutting Ø35 mm	4932430839	4002395385010
	Cu/Al standard copper & aluminium cable cutting blades	Cu/Al standard copper & aluminium cable cutting blades. The blades fit for the Cu/Al cutting jaws for M18HCC & ONEHCC cutters + M18 HCCT crimper cutting jaw	4932464498	4058546224431
c.	FSW fine stranded wire cutting jaw including blades	Cable cutter jaw and blades for class 5 fine stranded wire and class 6 finest stranded wire according to IEC 60228/DIN VDE 0295 standards. Also suitable for high flexible data- and telecom cable. Not suitable for thick stranded cables. Max. cutting Ø35 mm	49162778	045242505722
	FSW fine stranded wire cutting blades	FSW fine stranded wire cutting blade	48442778	045242505739
d.	EHS guy wire/steel wire cutting jaw including blades	Cutting jaw and blades for EHS grade guy wire, stay wire & steel wire according to DIN48201/3 guy wire of grade ST1/ST2/ST3. Not suitable for fine stranded steel ropes. Max. cutting Ø15 mm	49162777	045242505449
	EHS guy wire/steel wire cutting blades	EHS guy wire/steel wire cutting blades	48442777	045242505456
e.	Armored cable cutting Jaw for M18 HCC	Armored cable cutting Jaw for M18 HCC	4932464867	4058546228125
f.	Replacement blade for M18 HCC125/ M18 HSFC125	Latch replacement blade for M18 HCC125/ M18 HSFC125	4932492423	4058546417901
		Moving ram replacement blade for M18 HCC125/ M18 HSFC125	4932492424	4058546417918
g.	Grounding kit for M18 HSFC125	Grounding kit for M18 HSFC125	4932492425	4058546417925



SYSTEM ATTACHMENTS - THREADED ROD CUTTER

	Description	Article Number	EAN Code
a.	Dies for M18™ BLTRC threaded rod cutter	4932471372	4058546290009



STRUT SHEAR DIES

	Description	Article Number	EAN Code
	Strut shear die set 22 x 41 mm	49160078	045242821914
a.	Strut shear die set 41 x 41 mm	49160158	045242821891
	Strut shear die set 21 x 41 mm	49161316	045242821907
	Strut shear combination die set 21 x 41	49161513	045242821921
b.	Strut shear combination die set 22 x 41	49161578	045242821938

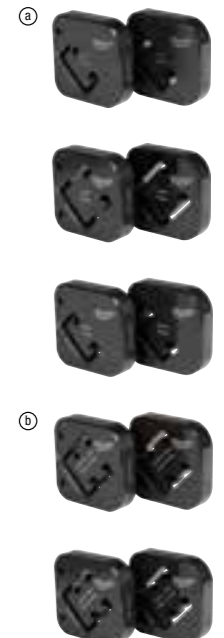

SYSTEM ATTACHMENTS - M18 FUEL™ FISH TAPES



	Description	Article Number	EAN Code
a.	Steel fish drums		
	36 m x 3 mm steel fish drum	48445176	4058546326432
	72 m x 3 mm steel fish drum	48445178	4058546326449
b.	Non-conductive drums		
	30 m non-conductive polyester drum	48445195	4058546326463
	60 m non-conductive polyester drum	48445197	4058546326470



SYSTEM ATTACHMENTS - HYDRAULIC KNOCKOUT PUNCH

	Description	Diameter (mm)	Article Number	EAN Code		Description	Diameter (mm)	Article Number	EAN Code	
	Punch M16	16.2	4932430841	4002395385034		Die M16	16.2	4932430913	4002395385751	
	Punch PG16	22.5	4932430843	4002395385058		Die PG16	22.5	4932430915	4002395385775	
	Punch M20	20.4	4932430842	4002395385041		Die M20	20.4	4932430914	4002395385768	
	Punch PG21	28.3	4932430845	4002395385072		Die PG21	28.3	4932430917	4002395385799	
a.	Punch M25	25.4	4932430844	4002395385065		a.	Die M25	25.4	4932430916	4002395385782
	Punch M32	32.5	4932430846	4002395385089		Die M32	32.5	4932430918	4002395385805	
	Punch M40	40.5	4932430847	4002395385096		Die M40	40.5	4932430919	4002395385812	
	Punch M50	50.5	4932430848	4002395385102		Die M50	50.5	4932430920	4002395385829	
	Punch M63	63.5	4932430849	4002395385119		Die M63	63.5	4932430921	4002395385836	

◦ Suitable for mild steel and aluminium up to a thickness of 3 mm.
◦ Also suitable for stainless steel max. 2.5 mm.

b.	Draw bolt 11.1 mm (7/16)	Draw stud bolt 49162680 (for 16.2 and 20.4 mm) Ø 11.1 mm: requires pre-drilling with Ø 11.3 - 11.5 mm drill bit / step drill.		49162680	045242311774	
c.	Draw bolt 19 mm (3/4)	Draw stud bolt 49162681 Ø 19 mm: requires pre-drilling with Ø 19.5 - 20 mm drill bit / step drill.		49162681	045242311781	

SYSTEM ATTACHMENTS - HYDRAULIC PUMP

	Description	Features	Article Number	EAN Code
a.	1.8 m extension cord for M18 HUP controller	<ul style="list-style-type: none"> ◦ Compatible with M18™ FORCE LOGIC™ hydraulic pump ◦ IP 67 ingress protection for reliable use in the elements ◦ Male-female connectors for interconnectable extension up to 7.3 m of length 	49122775	4058546326487
b.	Bucket hanger for M18 HUP700	<ul style="list-style-type: none"> ◦ Compatible with M18™ FORCE LOGIC™ hydraulic pump ◦ Extendable bar & rubber bumpers allow for use with most existing buckets & steel baskets ◦ Symmetrical lift ring design enable use from both sides of the hanger ◦ Keeps pump in ideal, level operating position while freeing up space inside the bucket 	49122776	045242535231
c.	Replacement oil M18 HUP700	<ul style="list-style-type: none"> ◦ 1 Liter accessory oil for M18™ FORCE LOGIC™ HUP700 hydraulic pump ◦ Ensures full performance and reliable use in extreme environmental conditions from -18°C to 50°C 	4932472004	4058546324001



SYSTEM ATTACHMENTS - EXPANSION TOOLS

	Pipe diameter (mm)	Pipe wall thickness (mm)	Pipe pressure (bar)	Suitable	Article Number	EAN Code	
	PXPH 9.9 - 144/8	9.9	1.1	4/8	M12, M18	4932430102	4002395377633
	PXPH 12I - 14	12	1.7/ 1.8/ 2	6-10	M12, M18	4932352716	4002395373741
	PXPH 15N - 14	14 / 15	2.5	6-10	M12, M18	4932352727	4002395373857
	PXPH 16I - 1406	16	1.5/ 1.8	6	M12, M18	4932430103	4002395377640
	PXPH 16I - 14	16	1.8/ 2.0/ 2.2	10	M12, M18	4932352717	4002395373758
	PXPH 18N - 14	17 / 18	2.5	6-10	M12, M18	4932352728	4002395373864
	PXPH 20I - 1406	20	1.9/ 2.0/ 2.3	6, (8 bar - Ø 2.3 mm)	M12, M18	4932352718	4002395373765
	PXPH 20I - 1410	20	2.8	10	M12, M18	4932352719	4002395373772
	PXPH 22N - 14	22	3	6-10	M12, M18	4932352729	4002395373871
	PXPH 25I - 1406	25	2.3	6	M12, M18	4932352720	4002395373789
a.	PXPH 25I - 1410	25	3.5	10	M12, M18	4932352721	4002395373796
	PXPH 28N - 14	28	4	6-10	M12, M18	4932352730	4002395373888
	PXPH 32I - 1406	32	2.9	6	M12, M18	4932352723	4002395373819
	PXPH 32I - 25	32	2.9/ 4.4	6-10	M18	4932352724	4002395373826
	PXPH 40I - 2506	40	3.7	6	M18	4932352725	4002395373833
	PXPH 40I - 2510	40	5.5	10	M18 FPXP	4932479581	4058546373757
	PXPH 40I - 5606	40	3.7	6-10	M18 BLPXPL	4932451396	4002395160884
	PXPH 50I - 25	50	4.6/ 6.9	6-10	M18 FPXP	4932479582	4058546373764
	PXPH 50I - 5606	50	4.6	6-10	M18 BLPXPL	4932451397	4002395160891
	PXPH 63I - 5606	63	5.8	6-10	M18 BLPXPL	4932451398	4002395158102
	PXPH 75I - 5606	75	6.8	6-10	M18 BLPXPL	4932451399	4002395158119
b.	Grease		For lubrication of cone and expander heads.		4932352726	4002395373840	

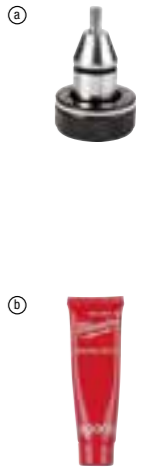

RAPID SEAL™ EXPANDER HEADS

	Pipe diameter (mm)	Pipe wall thickness (mm)	Pipe pressure (bar)	Suitable	Article Number	EAN Code	
	FPXPH9.9I-14	9.9	1.1	4-8	M12, M18	4932472150	4058546325466
	FPXPH16I-14	16	1.5/ 1.8/ 2.0/ 2.2	6-10	M12, M18	4932472151	4058546325473
	FPXPH20I-1406	20	1.9/ 2.0/ 2.3	6-8	M12, M18	4932472152	4058546325480
a.	FPXPH20I-1410	20	2.8	10	M12, M18	4932472153	4058546325497
	FPXPH25I-1406	25	2.3	6	M12, M18	4932472271	4058546339173
	FPXPH25I-1410	25	3.5	10	M12, M18	4932472272	4058546339180
	FPXPH32I-1406	32	2.9	6	M12, M18	4932472273	4058546339197



SYSTEM ATTACHMENTS - CAULK GUNS

	Description	Fits MILWAUKEE® caulk guns	Article Number	EAN Code
a.	310 ml standard carriage. Accepts all standard 250 ml and 310 ml tubes/cartridges. Includes plunger rod assembly (4932352937), piston for carriage assemblies and a feed screw (44700330)	C18 PCG	48081076	045242263127
b.	310 ml standard carriage. Accepts all standard 250 ml and 310 ml tubes/cartridges. Includes plunger rod assembly (4932430099), piston for carriage assemblies and a feed screw (44700330)	C12 PCG	48080900	045242286355
c.	400 ml aluminium sausage tube barrel. Accepts standard 400 ml "sausage style" material packs (includes 2 end cups). Requires plunger rod (48091090) and piston (44700375)	C18 PCG,C12 PCG	4932352844	4002395375028
d.	600 ml aluminium sausage tube barrel. Accepts standard 600 ml "sausage style" material packs (includes 2 end cups). Requires plunger rod (48091091) and piston (44700375)	C18 PCG,C12 PCG	4932352845	4002395375035
e.	400 ml transparent sausage tube barrel. Accepts standard 400 ml "sausage style" material packs (includes 2 end cups). Requires plunger rod (48091090) and piston (44700375)	C18 PCG,C12 PCG	4932352842	4002395375004
f.	600 ml transparent sausage tube barrel. Accepts standard 600 ml "sausage style" material packs (includes 2 end cups). Requires plunger rod (48091091) and piston (44700375)	C18 PCG,C12 PCG	4932352843	4002395375011
g.	Plunger rod assembly for 310 ml cartridges. For use with: 48081076 310 ml standard carriage	C18 PCG	4932352937	4002395375950
h.	Plunger rod assembly for 310 ml carriage. For use with: 48080900 310 ml standard carriage	C12 PCG	4932430099	4002395377602
i.	Plunger rod short (340 mm long). For use with: 48081075 carriage and 48081085 "sausage style" barrel	PCG 14 / 300,PCG 14 / 600	49520600	045242190201
j.	Plunger rod assembly for 400 ml sausage tube barrel. For use with: 4932352844 400 ml aluminium sausage tube barrel. 4932352842 400 ml transparent sausage tube barrel	C18 PCG	48091090	045242263158
k.	Plunger rod assembly for 400 ml sausage tube barrel. For use with: 4932352844 400 ml aluminium sausage tube barrel. 4932352842 400 ml transparent sausage tube barrel	C12 PCG	4932430100	4002395377619
l.	Plunger rod assembly for 600 ml sausage tube barrel. For use with: 4932352845 600 ml aluminium sausage tube barrel. 4932352843 600 ml transparent sausage tube barrel	C18 PCG	48091091	045242263165
m.	Plunger rod assembly for 600 ml sausage tube barrel. For use with: 4932352845 600 ml aluminium sausage tube barrel. 4932352843 600 ml transparent sausage tube barrel	C12 PCG	4932430101	4002395377626
n.	Piston for carriage assemblies	C18 PCG,C12 PCG	44700330	045242260928
o.	Piston for sausage tube barrels	C18 PCG,C12 PCG	44700375	045242277438
p.	Coupling for M12™ sub compact grease gun	-	4932501095	4058546623975
q.	Coupling for M18™ grease gun	-	4932501096	4058546623982



SYSTEM ATTACHMENTS - ELECTRICAL TEST & MEASURING

	Description	Article Number	EAN Code
a.	Electrical alligator clips (max. 1000 Volts/ 10 Amps)	49771005	045242238972



SYSTEM ATTACHMENTS - ONE-KEY™ BLUETOOTH® TRACKING

	Model	Description	Article Number	EAN Code
a.	AIDT	AIDT small plastic surface	4932480559	4058546408442
b.		AIDT large plastic surface	4932480560	4058546408459
c.		AIDT small metal surface	4932480561	4058546408466
d.		AIDT large metal surface	4932480562	4058546408473
e.	BTT	MILWAUKEE® ONE-KEY™ Bluetooth® tracking tag - BTT	4933478640	4058546348335
		MILWAUKEE® ONE-KEY™ Bluetooth® tracking tag - BTT - 10 pc	4933478643	4058546348366



SYSTEM ATTACHMENTS - ROUTERS

		Description	Article Number	EAN Code
a.	TRB-1	Trim router offset base attachment, for trimming close to walls	4932471946	4058546298456
b.	TRB-2	Trim router offset base attachment for M18 FTR8	4932493596	4058546484675
c.	RCA-1	Quarter inch collet and nut for M18 FTR8	4932479425	4058546372194
d.	TRA-2	Plunge base for M18 FTR and M18 FTR8	4932480544	4058546408299
e.	RBA-1	12 mm router plunge base to be used with M18 FR12	4932493307	4058546481780
f.	RBA-2	Router guide rail adaptor attaches the M18 FR12 router to the current MILWAUKEE® guide rails	4932493306	4058546481773
g.	RC600	6 mm collet and nut for M18 FR12	4932493912	4058546510725
	RC635	6.35 mm (1/4") collet and nut for M18 FR12 router	4932493913	4058546510732
	RC800	8 mm collet and nut for M18 FR12 router	4932493914	4058546510749
	RC1200	12 mm collet and nut for M18 FR12 router	4932493915	4058546510756
	RC1250	12.5 mm (1/2") collet and nut for M18 FR12 router	4932493916	4058546510763



SYSTEM ATTACHMENTS - INSPECTION CAMERAS

	Description	Cable length (m)	Cable diameter (mm)	Fits MILWAUKEE® inspection cameras	Article Number	EAN Code
a.	Cable extension: Up to a maximum of 5 extensions can be fixed together	0.9	17	C12 AVD, C12 AVA	48530141	045242216529
	1m replacement cable camera for the M-spector camera	1	12	M12 IC AV3	48530150	045242344208
b.	1 m articulating cable	1	12	M12 IC AV3	48530155	045242344215
c.	Skid set for M18™SIC36	-	-	M18 SIC36	4931473616	4058546354923
d.	Skid set for M18™SIC60	-	-	M18 SIC60	4931473638	4058546355142
e.	Grounding kit for M18™SISH	-	-	M18 SISH	4931473526	4058546354022
g.	Sewer inspection tablet mount	-	-	M18 SIC60SC HDR, M18 SIC60 HDR, M18 SIC36 HDR, M18 SIC30 HDR	4932478406	4058546324100
h.	5.0 mm replacement camera for M12™ automotive technician borescope	1.5	5.0	M12 ATB, M12 APB	4932500241	4058546615437
i.	10 mm camera head -3 m inspection camera for M12™ sewer inspection monitor	3	6	M12 SIM	4932498227	4058546520960
	10 mm camera head - 1.2 m inspection camera for M12™ sewer inspection monitor	1.2	6	M12 SIM	4932498228	4058546520977
j.	Ultra flexible replacement push cable and drum for M12 SICO20, for pipe diameter from 32 mm to 70 mm	20	6.5	M12 SICO20	4932501258	4058546639747
	High flexible replacement push cable and drum for M12 SICO26, for pipe diameter from 32 mm to 100 mm	26	7.25	M12 SICO26	4932501259	4058546639754
k.	Replacement spring for M12 SICO20	-	-	M12 SICO20	4932501260	4058546639761
	Replacement spring for M12 SICO26	-	-	M12 SICO26	4932501261	4058546639778
l.	16 mm replacement camera head kit for M12 SICO20	-	-	M12 SICO20	4932501262	4058546639785
	20 mm replacement camera head kit for M12 SICO26	-	-	M12 SICO26	4932501263	4058546639792
m.	Barrel skids for M12 SICO20, for pipes from 32 mm to 70 mm	-	-	M12 SICO20	4932501264	4058546639808
	Barrel skids for M12 SICO26, for pipes from 40 mm to 100 mm	-	-	M12 SICO26	4932501265	4058546639815
n.	Monitor mount for M12 SIM and M12 SICO	-	-	M12 SICO26, M12 SICO20	4932501266	4058546639822
o.	25 mm HDR camera head replacement kit for M18 SIC30 HDR, M18 SIC36 HDR, M18 SIC60SC HDR	-	-	M18 SIC60SC HDR, M18 SIC36 HDR, M18 SIC30 HDR	4932501267	4058546639839
	34 mm HDR camera head replacement kit for M18 SIC60 HDR	-	-	M18 SIC60 HDR	4932501268	4058546639846



SYSTEM ATTACHMENTS - PIPE STAND

	Description	Article Number	EAN Code
a.	MILWAUKEE® pipe stand replaceable jaws	4932478923	4058546362058
	MILWAUKEE® pipe stand neoprene jaws	4932478924	4058546362065
b.	MILWAUKEE® pipe stand stainless steel jaws	4932478925	4058546362072
c.	MILWAUKEE® pipe stand removeable shelf	4932478926	4058546362089

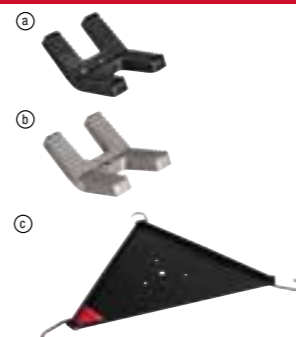

SYSTEM ATTACHMENTS - PASS-THROUGH RATCHET

	Description	Article Number	EAN Code	
a.	INSIDER™ pass-through ratchet socket 8 mm (pass-through)	4932492855	4058546477264	
	INSIDER™ pass-through ratchet socket 9 mm (pass-through)	4932492856	4058546477271	
	INSIDER™ pass-through ratchet socket 10 mm (pass-through)	4932492857	4058546477288	
	INSIDER™ pass-through ratchet socket 11 mm (pass-through)	4932492858	4058546477295	
	INSIDER™ pass-through ratchet socket 12 mm (pass-through)	4932492859	4058546477301	
	INSIDER™ pass-through ratchet socket 13 mm (pass-through)	4932492860	4058546477318	
	INSIDER™ pass-through ratchet socket 14 mm (pass-through)	4932492861	4058546477325	
	INSIDER™ pass-through ratchet socket 15 mm (pass-through)	4932492862	4058546477332	
	INSIDER™ pass-through ratchet socket 16 mm	4932492863	4058546477349	
	INSIDER™ pass-through ratchet socket 17 mm	4932492864	4058546477356	
b.	INSIDER™ pass-through ratchet socket 18 mm	4932492865	4058546477363	
	INSIDER™ pass-through ratchet socket 19 mm	4932492866	4058546477370	
	INSIDER™ pass-through ratchet socket 21 mm	4932492867	4058546477387	
c.	INSIDER™ pass-through ratchet 1/4" anvil adapter	4932499408	4058546565725	
	INSIDER™ pass-through ratchet 3/8" anvil adapter	4932499409	4058546565732	
	INSIDER™ pass-through ratchet 1/2" anvil adapter	4932499410	4058546565749	
d.	INSIDER™ pass-through ratchet Hex bit holders	INSIDER™ pass-through ratchet 1/4" Hex bit holder	4932492871	4058546477424



SYSTEM ATTACHMENTS - DUST ABSORPTION

M12™ / M18™ DUST ABSORPTION SYSTEM

	Description	Fits MILWAUKEE® Dust Extractors	Pack quantity	Min. order quantity	Article Number	EAN Code
a.	Drilling nozzle	M18 CDEX / M18/28 CPDEX, M12 DE	2	1	49902301	045242337279
b.	Filter	M18 CDEX / M18/28 CPDEX, M12 DE	3	1	49902306	045242299454
c.	Crevice nozzle	M12 DE	1	1	49902325*	045242297603
d.	Filter set (3pc)	M12 DE	3	1	49902340	045242299461
	Filter box, filter, box lid					
e.	M18 & M28 Dustbox with filter box, filter	M18 CDEX / M18/28 CPDEX	4	1	49902342	045242341948
f.	Dust thru-box to allow connection of the M12 DE to an independent dust extraction / vacuum cleaner. Outlet nozzle: Ø 37 mm outside / Ø 32 mm inside		1	1	4932430479	4002395381401
g.	Drilling shroud - PHDE152		1	1	4932471990	4058546298890



VACUUM CLEANERS

	Description	Fits MILWAUKEE® dust extractors	Article Number	EAN Code
a	Extraction hose, anti static, 4 m long 36 mm diameter with tool adaptor	AS 300 ELCPIAS 500 ELCPIAS 300 EMAC	4932352311	4002395369706
	Universal adaptor Ø 35 / 33 / 27 mm	WDC 1400 AIAS 1IAS 2 CIAS 3 WIASE 1400/ASM 1400	4932369282	4002395338412
	Extraction hose Ø 35 mm / 5 m	ASE 1400/ASM 1400	4932373626	4002395351534
b.	Metal push handle	AS 42 MACIAS 30 MACIAS 30 LAC	4932459691	4058546028633
c.	27 mm x 3.5 m hose attachment	AS2-250EM/H	4932498236	4058546521059
d.	PACKOUT™ compatible dust separator	M18 FPOVCL	4932498256	4058546521257
e.	Cleaning and accessories set for M18 FUJEL™ M class AC/DC dual battery dust extractor with VACLINK™	M18 ONEF2VC34M	4932498660	4058546525293
f.	6 m hose attachment for M18 FUJEL™ M class AC/DC dual battery dust extractor with VACLINK™	M18 ONEF2VC34M	4932498661	4058546525309
g.	NEXUS mid-stack dust separator	M18 F2VC23LIM18 F2VC23LG2	4932500534	4058546618360
h.	NEXUS mid-stack filter cleaner	M18 F2VC23LIM18 F2VC23LG2	4932500535	4058546618377



FILTER BAGS

	Description	Fits MILWAUKEE® Dust Extractors	Capacity (l)	Article Number	EAN Code
a.	Filter bags (5pc)	AS 250 ECP	25	4932352306	4002395369652
b.	Filter bags	AS 300 ELC, AS 300 EMAC, AS 300 ELAC	30	4932352307	4002395369669
c.	Filter bags: 5 x plastic bags, 30 l	AS 250 ECP, AS 300 ELC, AS 300 EMAC	30	4932352309	4002395369683
d.	Disposable bags 30 l	AS 42 MAC, AS 30 MAC, AS 30 LAC	30	4932459690	4058546028626
e.	Filter bags	AS 500 ELC	50	4932352308	4002395369676
f.	Fleece filter bags for AS 30/42	AS 30 LAC, AS 30 MAC, AS 42 MAC	30	4932459689	4058546028619
g.	Fleece filter bag (5pc)	M18 F2VC23L	23	4932479807	4058546376017
h.	Fleece bags (3pc)	M18 FPOVCL, M12 FVCL	3.5	4932478762	4058546360443
i.	Fleece dust bag for M18 FUJEL™ M class AC/DC dual battery dust extractor with VACLINK™	M18 ONEF2VC34M	34	4932498663	4058546525323
j.	Filter cleaning kit for M18 FUJEL™ M class AC/DC dual battery dust extractor with VACLINK™	M18 ONEF2VC34M	-	4932498662	4058546525316
k.	Filter for M18 FUJEL™ backpack vacuum	M18 FBPV2	-	4932500170	4058546614720



FILTER CARTRIDGES

	Description	Fits MILWAUKEE® Dust Extractors	Article Number	EAN Code
a.	Filter cartridges, 2pc	AS 300 EMAC, AS 300 ELAC	4932352305	4002395369645
b.	Filter cartridge	AS 250 ECP, AS 250 ECP	4932352303	4002395369621
c.	Filter cartridge	AS 300 ELC, AS 500 ELC, AS 2-250 ELC	4932352304	4002395369638
d.	Flat folded polyester filter cartridge, 2 pcs	ASE 1400, ASM 1400	4932373623	4002395351510
e.	PTFE flat filter	AS 30 LAC, AS 42 MAC, AS 30 MAC	4932459687	4058546028596
f.	Motor cooling filter	AS 42 MAC, AS 30 MAC, AS 30 LAC	4932459688	4058546028602
g.	Wet filter universal	M12 FVCL, M18 FPOVCL, M18 VC2	4932478802	4058546360849
h.	Wet filter replacement	M18 F2VC23L	4932479806	4058546376000
i.	Dry HEPA filter universal replacement	M12 FVCL, M18 FPOVCL, M18 VC2	4932478754	4058546360368
j.	Dry HEPA filter replacement for M18 FVCL	M18 FVCL	4932478814	4058546360962
k.	Dry HEPA filter replacement	M18 F2VC23L	4932479805	4058546375997
l.	H-Class filter	AS 2-250EH	4932498235	4058546521042



SYSTEM ATTACHMENTS - AIR TIP™ ATTACHMENTS

	Description	Features	Article Number	EAN Code
a.	AT-1 AIR-TIP™ dust collector	<ul style="list-style-type: none"> Funnel design to capture more debris Uses the vacuums suction to suck to walls, allowing for hands-free use Compatible with other wet/ dry vacuum brands with 32 mm, 47.5 mm, and 63.5 mm hose diameters Strong rubber seal 	4932498010	4058546511708
b.	AT-2 AIR-TIP™ 3-in-1 crevice and brush tool	<ul style="list-style-type: none"> Reversible and removeable 2-sided brush head Two-sided brush head has long/ soft bristles on one side, and short/ stiff bristles on the other Brush head slides and removes easily with two detent buttons 	4932498011	4058546511715
c.	AT-3 AIR-TIP™ 2-in-1 utility brush tool	<ul style="list-style-type: none"> Brush tool slides and locks into place Agitating brushes for easy debris removal Length 28.4 cm Compatible with other wet/ dry vacuum brands with 32 mm, 47.5 mm, and 63.5 mm hose diameters 	4932498012	4058546511722
d.	AT-4 AIR-TIP™ long reach flexible micro hose set	<ul style="list-style-type: none"> Five interchangeable micro hose lengths and diameters for many hard to reach spaces Can be used in a variety of spaces like automotive, HVAC, plumbing, light fixtures, condensate lines, and many more 	4932498013	4058546511739
e.	AT-5 AIR-TIP™ cross brush tool	<ul style="list-style-type: none"> Cross bristle design mitigates pushing debris away from the cleaning area Agitating brushes for easy debris removal Compatible with other wet/ dry vacuum brands with 32 mm, 47.5 mm, and 63.5 mm hose diameters Bristles will not mar or scratch surfaces 	4932498014	4058546511746
f.	AT-6 AIR-TIP™ swiveling palm brush	<ul style="list-style-type: none"> Swivels 360° Interchangeable bristle/ brush heads included Compatible with other wet/ dry vacuum brands with 32 mm, 47.5 mm, and 63.5 mm hose diameters 	4932498015	4058546511753
g.	AT-7 AIR-TIP™ pivoting extension wand	<ul style="list-style-type: none"> Strong detent mechanism Pivoting 90° joint allows for greater cleaning access overhead and below Compatible with other wet/ dry vacuum brands with 32 mm, 47.5 mm, and 63.5 mm hose diameters Can hold 32 mm accessories on the end of the tip 	4932498016	4058546511760
h.	AT-8 AIR-TIP™ rotating corner brush tool	<ul style="list-style-type: none"> 360° rotating brush head Agitating brushes for easy debris removal Compatible with other wet/ dry vacuum brands with 32 mm, 47.5 mm, and 63.5 mm hose diameters Corner shaped tip 	4932498017	4058546511777
i.	AT-9 AIR-TIP™ conduit line puller kit	<ul style="list-style-type: none"> Flexible rubber design to fit into small conduit boxes and tight areas Narrow ends and cross design stopper prevents line and bag from sucking into the vacuum Rubber cone seal 	4932498018	4058546511784
j.	AT-10 AIR-TIP™ low profile pivoting brush tool	<ul style="list-style-type: none"> Strong pivoting joint for use in multiple orientations 360° flat swiveling head Bristles will not mar or scratch surfaces Agitating brushes for easy debris removal 	4932498019	4058546511791
k.	AT-11 AIR-TIP™ magnetic utility nozzle	<ul style="list-style-type: none"> Black zinc coating prevents rust Optimised for handheld use Compatible with other wet/ dry vacuum brands with 32 mm, 47.5 mm, and 63.5 mm hose diameters 	4932498020	4058546511807
l.	AT-12 AIR-TIP™ 4-in-1 right angle cleaning tool	<ul style="list-style-type: none"> Gradual bend and right angle design can be used around pipes near walls and in a variety of tight access cleaning situations Compatible with other wet/ dry vacuum brands with 32 mm, 47.5 mm, and 63.5 mm hose diameters Tip holder stores the 4 included tips 	4932498021	4058546511814
m.	AT-13 AIR-TIP™ flexible long reach crevice tool	<ul style="list-style-type: none"> Flexible tool shaft can bend to reach into difficult areas 40 cm in overall length Compatible with other wet/ dry vacuum brands with 32 mm, 47.5 mm, and 63.5 mm hose diameters Durable and flexible rubber material 	4932498022	4058546511821
n.	AT-14 AIR-TIP™ non-marring utility nozzle kit	<ul style="list-style-type: none"> Specialised resin allows for each tip to be used on finished surfaces without marking up the area Compatible with other wet/ dry vacuum brands with 32 mm, 47.5 mm, and 63.5 mm hose diameters Non-marring edges indicated by the black surface on each tool 	4932498023	4058546511838
o.	AT-15 AIR-TIP™ claw utility nozzle with brushes	<ul style="list-style-type: none"> Ergonomic claw grips and integrated bristles allows for more cleaning leverage and agitation in the same application Agitating brushes for easy debris removal Compatible with other wet/ dry vacuum brands with 32 mm, 47.5 mm, and 63.5 mm hose diameters 	4932498024	4058546511845
p.	AT-16 AIR-TIP™ rocking utility nozzle with brushes	<ul style="list-style-type: none"> Easier to push and pull across surfaces Agitating brushes for easy debris removal Compatible with other wet/ dry vacuum brands with 32 mm, 47.5 mm, and 63.5 mm hose diameters Beveled design optimised for both forward and backward cleaning strokes 	4932498025	4058546511852
q.	M12 AUN M12™ AIR-TIP™ utility nozzle	<ul style="list-style-type: none"> The M12™ powered utility nozzle is a great accessory that is designed to clean jobsite debris on short and medium hair carpeted surfaces The universal reception fits to all MILWAUKEE® M12™ and M18™ cordless vacs and covers most common hose sizes (Ø 31.8 mm, 47.6 mm and 63.5 mm) 	4932479461	4058546372552

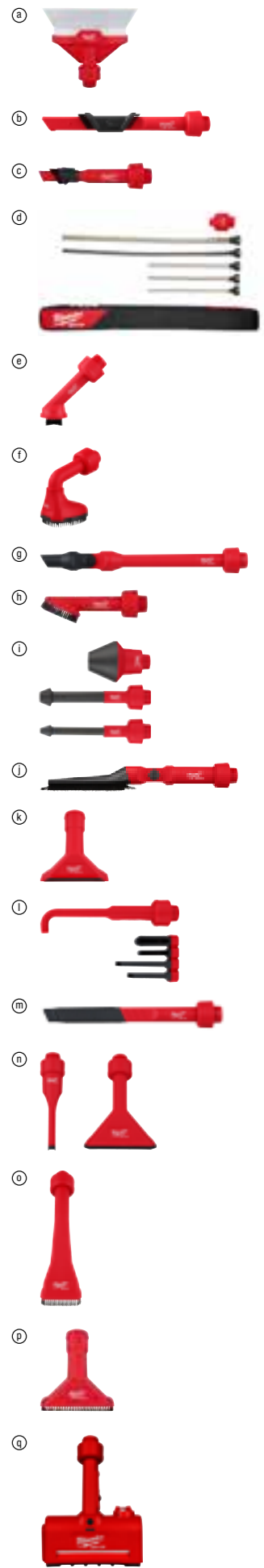

SYSTEM ATTACHMENTS - PORTABLE BATTERY EXTENSION

	Description	Article Number	EAN Code
a.	MXF PBET-24 MX FUEL™ portable battery extension tether 2.4 m with mock battery	4932498068	4058546512286
b.	TC-USBC100 100 W USB-C wall adaptor	4932500226	4058546615284



SYSTEM ATTACHMENTS - LASERS

	Description	Article Number	EAN Code
a.	LM360 360° laser mount	4932478105	4058546340384
b.	LWM Laser wall mount	4932493201	4058546480721
c.	HI-VIST High visibility laser target plate	4932478108	4058546340414
d.	LMP 3.6 m telescoping laser pole	4932479205	4058546369996
e.	WLB Wireless laser alignment base	4932479198	4058546369927
f.	TRP300 3.0 metre laser tripod	4932493200	4058546480714
g.	TRP180 1.8 meter laser tripod	4932478106	4058546340391
h.	TRP160 1.6 metre laser tripod	4932493199	4058546480707
i.	TRP120 1.2 meter compact laser tripod	4932478959	4058546362416
j.	SR240 240 cm staff rod	4932493202	4058546480738
k.	ROD500 500 cm grade rod	4932493203	4058546480745



PERSONAL PROTECTIVE EQUIPMENT

BOLT™ HEAD PROTECTION

PERSONAL LIGHTING

MASKS

EYE PROTECTION

EAR PROTECTION

WORKWEAR

HIGH-VIS VESTS

CUT RESISTANT & SPECIAL APPLICATION GLOVES

WORK PANTS

TOOL LANYARDS

KNEE PADS

FOOTWEAR



BOLT™ 200



BOLT™ 100



ACCESSORIES SETS

	1/2" SHOCKWAVE™ IMPACT DUTY deep socket set (10pc)	1/2" SHOCKWAVE™ IMPACT DUTY socket set STD (13pc)	3/4" socket set deep (5pc)	3/4" SHOCKWAVE™ IMPACT DUTY socket standard rail set (9pc)	BIG HAWG™ multi material set (10 pc)	Wood drill bit set (8pc)	165 x 20 mm Twin pack set (2pc)	190 x 30 mm Twin pack set (2pc)	DIAMOND MAX™ diamond drill bit set (5pc)	Flat bit set (8pc)
Contents	10 x deep sockets: 10, 11, 12, 13, 14, 17, 19, 21, 22, 24 mm	10 x STD sockets: 10,12,13,14,15,17,19,21,22,24, 1 x universal joint 15°, 1 x adaptor 1/4" Hex - 1/2" square, 1 x extension 150 mm	3/4" deep socket: 27,30,32,33,36 + safety ring + blow molded BMC	8 x impact standard sockets: 8 / 10 / 12 / 13 / 14 / 15 / 17 / 19 mm and socket rail	6 x holesaws: Ø 35, 44, 51, 57, 68, 76 mm. 1 x arbor with pilot drill. 2 x pilot drill. 1 x diamond file. Allen key	Ø 3 / 4 / 5 / 6 / 7 / 8 / 9 / 10 mm	2 x 165x20x40 tooth, fast and clean cut wood blade (4932471932)	1 x 190x30x24 tooth, fast cut wood blade (4932471300) + 1 x 190x30x48 tooth, clean cut wood blade (4932471380)	Ø 6 (2x), 8 (2x), 10 mm	Ø 12 / 16 / 18 / 20 / 22 / 25 / 28 / 32 x 152 mm length
Article Number	4932480457	4932480456	4932498750	4932480454	4932464939	4932352466	4932492433	4932479574	4932498299	4932352504
EAN Code	4058546407421	4058546407414	4058546526191	4058546407391	4058546228842	4002395371259	4058546418007	4058546373689	4058546521684	4002395371624



	SAWZALL™ blade set (5pc)	SAWZALL™ blade set (10pc)	SAWZALL™ blade set (12pc)	SAWZALL™ blade set (13pc)	SAWZALL™ carbide demolition blade set (5pc)	HOLE DOZER™ holesaw set (14pc)	Thunderweb HSS-Ground set CB (19pc)	Jigsaw blades set (35pc) - suitable for applications in wood and metal	Multi material drill bit set (8pc)	Renovation set (8pc)	
Contents	1 x AX™ wood with nails - 230 mm, 1 x WRECKER™ multi material - 230 mm, 1 x TORCH™ metal - 230 mm, 1 x TORCH™ metal - 150 mm, 1 x TORCH™ metal - 150 mm	3 x THIN KERF metal - 150 mm, 3 x THIN KERF metal - 150 mm, 2 x THIN KERF wood with nails - 150 mm, 1 x THIN KERF wood with nails - 230 mm, 1 x THIN KERF metal - 230 mm	2 x AX™ wood with nails - 150 mm, 2 x AX™ wood with nails - 230 mm, 4 x TORCH™ metal - 150 mm, 2 x TORCH™ metal - 230 mm, 2 x WRECKER™ multi material - 150 mm	2 x WRECKER™ multi material - 150 mm, 2 x AX™ wood with nails - 150 mm, 2 x AX™ wood with nails - 230 mm, 4 x TORCH™ metal - 150 mm, 2 x TORCH™ metal - 230 mm, 1 x TORCH™ carbide - 150 mm	2 x WRECKER™ multi material - 150 mm, 2 x AX™ wood with nails - 150 mm, 2 x AX™ wood with nails - 230 mm, 4 x TORCH™ metal - 150 mm, 2 x TORCH™ metal - 230 mm, 1 x TORCH™ carbide - 150 mm	Wood with nails: 2 x AX™ carbide - 230mm. Metal: 2 x TORCH™ carbide - 230mm, 1 x TORCH™ carbide - 150 mm	10 x holesaws: Ø 19, 22, 25, 29, 32, 35, 38, 44, 51, 57 mm. Arbor for Ø 14 - 30 mm holesaws. Arbor for Ø 32 - 152 mm holesaws. 2 x pilot drill bits. 1/8" allen key	Ø 1 / 1.5 / 2 / 2.5 / 3 / 3.5 / 4 / 4.5 / 5 / 5.5 / 6 / 6.5 / 7 / 7.5 / 8 / 8.5 / 9 / 9.5 / 10 mm	Contents: 7 x 4932213116 - T144D wood fast cut, 7 x 4932274351 - T101D wood clean cut, 7 x 4932254061 - T101B wood extra clean cut, 7 x 4932346078 - T244D wood fast curve cut, 7 x 4932254063 - T118A metal	Ø 4 x 100 mm, Ø 5 / 5 / 6 / 6 x 108 mm, Ø 8 / 10 x 120 mm, Ø 12 x 150 mm	2 x multi mat. 28mm plunge cut blade, 2 x multi mat. 43mm plunge cut blade, 1 x grout removal 2.2mm carbide blade, 1 x 3X cutting knife, 1 x rasp carbide grit, 1 x flexible scraper 52mm
Article Number	49472205	49472211	49472229	49472231	49472206	49224152	4932499766	4932479088	4932493871	48906088	
EAN Code	045242481408	045242481958	045242481934	045242481460	045242481446	045242271047	4058546569303	4058546368821	4058546510312	045242600649	



	SDS-Plus M2™ drill bit set (10pc)	SDS-Plus M2™ drill bit set (5pc)	SDS-Plus MX4™ NG set 1 (7pc)	SHOCKWAVE™ IMPACT DUTY bit set (40 pc)	SHOCKWAVE™ IMPACT DUTY Carabiner Set 2 (10 pc)	Counter display SHOCKWAVE™ Right Angle Attachment set (11pc)	SHOCKWAVE™ IMPACT DUTY bit set (32 pc)	Step drill set (3pc)	Wood and metal blade set (5pc)	Wood blade set (5pc)
Contents	Ø 5 / 5 / 6 / 6 x 110 mm and Ø 6 / 6 / 8 / 8 / 10 / 12 x 160 mm	Ø 5 / 6 x 110 mm and Ø 6 / 8 / 10 x 160 mm	Ø 5 / 6 x 115 mm, Ø 6 / 8 / 8 / 10 x 165 mm, Ø 12 x 165 mm	SHOCKWAVE™ screwdriving bits: 25 x 25 mm length 1 x PH1 / 2 x PH2, 1 x PZ1 / 3 x PZ2, 2 x TX10 / 2 x TX15 / 3 x TX20 / 3 x TX25 / 2 x TX30 / 1 x TX40, 1 x Hex 4 mm / 1 x Hex 5 mm, 1 x SL 0.6 x 4.5 / 1 x SL 0.8 x 5.5 / 1 x SL 1.2 x 6.5. 8 x 50 mm length 1 x PH2, 1 x PZ2, 1 x TX10 / 1 x TX15 / 1 x TX20 / 1 x TX25 / 1 x TX30 / 1 x TX40. SHOCKWAVE™ magnetic bit holder: 1 x 60 mm length, 1 x 152 mm length. 3 x SHOCKWAVE™ 1/4" Hex drill bits: Ø 3 / 4 / 5 mm. 2 x SHOCKWAVE™ magnetic nut drivers: 48 mm length 1 x Hex 8 mm / 1 x Hex 10 mm	Shockwave™ Impact Rated Screw-driving Bits: 10 x 50mm length: 4 x PH2 / 4 x PZ2 / 1 x TX20 / 1 x TX25	1 x Right Angle Attachment, 1 x PH2, 1 x PZ1 / 2 x PZ2 / 1 x PZ3, 1 x TX10 / 1 x TX15 / 1 x TX20 / 1 x TX25 / 1 x TX30	SHOCKWAVE™ screwdriving bits: 31 x 25 mm length: 1 x PH1 / 2 x PH2 / 1 x PH3, 1 x PZ1 / 2 x PZ2 / 1 x PZ3, 2 x TX10 / 2 x TX15 / 3 x TX20 / 2 x TX25 / 2 x TX30 / 1 x TX40, 1 x TX B07 / 1 x TX B08 / 1 x TX B09 / 1 x TX B010 / 1 x TX B015 / 1 x TX B020 / 1 x TX B025, 1 x Hex 3 mm / 1 x Hex 4 mm / 1 x Hex 5 mm / 1 x Hex 6 mm. 1 x SHOCKWAVE™ locking bit holder 1/4" Hex reception 73 mm long	Includes 3 step drill bits: 4 - 12 mm/1, 4 - 20 mm, 6 - 35 mm	1 x 48906011 35mm soft and hardwood plunge cut blade with 3 cut tooth geometry, 2 x 48906021 35mm wood and nails Bi-Metal plunge cut blade, 2 x 48906031 28mm multi material plunge cut blade	2 x 48906001 35mm wood plunge cut blade, 2 x 48906011 35mm soft and hardwood plunge cut blade with 3 cut tooth geometry, 1 x 48906021 35mm wood and nails Bi-Metal plunge cut blade
Article Number	4932492117	4932352338	4932500060	4932492004	4932492939	4932471274	4932464240	48899399	48906115	48906114
EAN Code	4058546414849	4002395369973	4058546572242	4058546413712	4058546478100	4058546289027	4058546221850	045242344420	045242670697	045242670680

PACKOUT™ MODULAR STORAGE SYSTEM

OVER 120 POSSIBLE SOLUTIONS



SITE

TRANSIT

SHOP



VIRTUALLY BUILD YOUR OWN PACKOUT™ STACK



MILWAUKEE® ACCESSORY SETS

SHOCKWAVE™ IMPACT DUTY M/2™ M/4™ RED HEX™ RED COBALT™ THUNDERWEB™

DESIGNED FOR USE IN PACKOUT™

MODULAR STORAGE SYSTEMS



TOOLGUARD™ STEEL STORAGE

BUILT-IN POWER CENTERS

CHARGE BATTERIES, TOOLS AND DEVICES DIRECTLY ON THE UNIT.

INTEGRATED STORAGE SOLUTIONS

FROM BUILT-IN POWER TOOL ORGANISERS AND STORAGE COMPARTMENTS TO WORK TOP DRAWERS AND PEG BOARDS.

ULTIMATE WORKSHOP DURABILITY

INDUSTRIAL GRADE CASTERS, CORNER BUMPERS AND SOFT-CLOSE DRAWER PROTECTION ARE JUST A FEW OF THE FEATURES THAT RESULT IN AN INVINCIBLE CONSTRUCTION.



VIRTUALLY CUSTOMISE YOUR TOOLGUARD™ STEEL STORAGE DRAWERS



CABLE PULLING



FASTENING



GRIPPING



HAMMERS



LEVELS



HAND TOOLS OVER 1600 SOLUTIONS

SAWS & CUTTERS



SCREWDRIVERS



KNIVES & BLADES



MEASURING &
LAYOUT



MARKING



SNIPS & SCISSORS



**VIEW THE FULL
HAND TOOLS
RANGE HERE**



INDEX

Model		Page	Name	Kit included	Standard equipment	Article Number	EAN Code
Angle grinders							
AG 10 EK	1000 W angle grinder	27	AG 10-115 EK	-	Quick release safety guard, side handle, flange, flange nut, 4 m cable, wrench	4933451219	4002395260867
			AG 10-125 EK	-	Quick release safety guard, side handle, flange, flange nut, 4 m cable, wrench	4933451220	4002395260874
AG 13 XSPD	1250 W angle grinder with slim paddle switch	27	AG 13-125 XSPD	-	Quick release guard, side handle, flange, flange nut, spanner, 4 m cable	4933451577	4002395140787
AG 22	2200 W angle grinder	27	AG 22-180 DMS	-	Safety guard, side handle, flange, flange nut, cable, wrench	4933431830	4002395243846
			AG 22-230 DMS	-	Safety guard, side handle, flange, flange nut, cable, wrench	4933433630	4002395244423
AG 24	2400 W angle grinder	27	AG 24-230 E	-	Quick release safety guard, side handle, flange nut, wrench, 4 m cable	4933402325	4002395234219
			AG 24-230 E DMS	-	Quick release safety guard, side handle, flange nut, wrench, 4 m cable	4933402450	4002395234325
AG 800 E	800 W angle grinder	27	AG 800-115 E	-	Safety guard, side handle, flange, flange nut, wrench	4933451210	4002395260171
			AG 800-125 E	-	Safety guard, side handle, flange, flange nut, wrench	4933451211	4002395260188
			AG 800-115 E D-SET	-	Safety guard, side handle, flange, flange nut, wrench, diamond disc	4933451281	4002395170777
AG 800 EK	800 W angle grinder with keyless guard	27	AG 800-125 EK	-	Quick release safety guard, side handle, flange, flange nut, wrench	4933451213	4002395260805
AGV 10 EK	1000 W angle grinder with AVS	27	AGV 10-125 EK	-	Quick release safety guard, AVS side handle, flange, flange nut, 4 m cable, wrench	4933451222	4002395260898
AGV 12	1200 W angle grinder with AVS	27	AGV 12-125 X	-	Quick release safety guard, AVS side handle, flange, flange nut, spanner, 4 m cable	4933428085	4002395239597
AGV 13	1250 W angle grinder with AVS and slide switch	26	AGV 13-125 XE	-	Quick release safety guard, AVS side handle, flange, flange nut, wrench	4933451218	4002395260850
AGV 13 XSPDE	1250 W angle grinder with AVS and slim paddle switch	27	AGV 13-125 XSPDE	-	Quick release safety guard, AVS side handle, flange, flange nut, spanner, 4 m cable	4933451578	4002395140794
AGV 13 XSPDEB	1250 W braking grinder with AVS and paddle switch	26	AGV 13-125 XSPDEB	-	Quick release safety guard, AVS side handle, flange, Fixtec nut, 4 m cable	4933464998	4058546229436
			AGV 13-125 XSPDEB KIT	-	Quick release safety guard, AVS side handle, flange, Fixtec nut, 4 m cable	4933471194	4058546288228
AGV 15	1550 W angle grinder with AVS	26	AGV 15-125 XC	-	Quick release safety guard, AVS side handle, flange, flange nut, 4 m cable	4933428120	4002395239641
			AGV 15-125 XE	-	Quick release safety guard, AVS side handle, flange, flange nut, 4 m cable	4933428127	4002395239658
			AGV 15-150 XC	-	Quick release safety guard, AVS side handle, flange, flange nut, 4 m cable	4933433250	4002395244164
AGV 17	1750 W angle grinder with AVS	27	AGV 17-125 XE	-	Quick release safety guard, AVS side handle, FIXTEC™ flange nut, flange nut, 4 m cable	4933432230	4002395243983
			AGV 17-125 XC	-	Quick release safety guard, AVS side handle, FIXTEC™ flange nut, flange nut, 4 m cable	4933449850	4002395247295
			AGV 17-125 XC DMS	-	Quick release safety guard, AVS side handle, FIXTEC™ flange nut, flange nut, 4 m cable	4933455140	4002395247905
			AGV 17-150 XC DMS	-	Quick release safety guard, AVS side handle, FIXTEC™ flange nut, flange nut, 4 m cable	4933432250	4002395243990
			AGV 17-180 XC DMS	-	Quick release safety guard, AVS side handle, FIXTEC™ flange nut, flange nut, 4 m cable	4933432270	4002395244003
AGV 17 INOX	1750 W low speed grinder with AVS	26	AGV 17-125 INOX	-	Quick release safety guard, AVS side handle, FIXTEC™ flange nut, flange nut, 4 m cable	4933449870	4002395247912
AGV 22	2200 W angle grinder with AVS	27	AGV 22-180 E	-	Quick release safety guard, AVS side handle, flange, flange nut, wrench, 4 m cable	4933431820	4002395243839
			AGV 22-230 DMS	-	Quick release safety guard, AVS side handle, flange, flange nut, wrench, 4 m cable	4933431860	4002395243877
			AGV 22-230 E	-	Quick release safety guard, AVS side handle, flange, flange nut, wrench, 4 m cable	4933431850	4002395243860
AGV 24	2400 W angle grinder with AVS	27	AGV 24-230 GE	-	Quick release safety guard, AVS side handle, Autobalancer, flange nut, wrench, 4 m cable	4933402330	4002395234226
AGV 26	2600 W angle grinder with AVS	26	AGV 26-230 GE	-	Quick release safety guard, AVS side handle, Autobalancer, flange nut, wrench, 4 m cable	4933402360	4002395234257

Model		Page	Name	Kit included	Standard equipment	Article Number	EAN Code
			AGV 26-230 GE DMS	-	Quick release safety guard, AVS side handle, Autobalancer, flange nut, wrench, 4 m cable	4933402490	4002395234356
AGVK 24	2400 W angle grinder with AVS and kickback protection	26	AGVK 24-230 EK	-	Quick release safety guard, AVS side handle, flange, flange nut, wrench, 4 m cable	4933451413	4002395161683
			AGVK 24-230 EK DMS	-	Quick release safety guard, AVS side handle, flange, flange nut, wrench, 4 m cable	4933451414	4002395161690
AGVKB 24	2400 W angle grinder with brake, kickback protection and AVS	26	AGVKB 24-230 EKX	-	release safety guard, AVS side handle, flange, FIXTEC™ nut, wrench, 4 m cable	4933471464	4058546293635
AGVM 24	2400 W angle grinder with AVS and kickback protection	26	AGVM 24-230 GEX	-	Quick release safety guard, AVS side handle, Autobalancer, FIXTEC™ flange nut, 4 m cable	4933402340	4002395234240
AGVM 26	2600 W angle grinder with AVS and kickback protection	26	AGVM 26-230 GEX	-	Quick release safety guard, AVS side handle, Autobalancer, FIXTEC™ flange nut, 4 m cable	4933402365	4002395234271
			AGVM 26-230 GEX DMS	-	Quick release safety guard, AVS side handle, Autobalancer, FIXTEC™ flange nut, 4 m cable	4933402495	4002395234394
M18 BLSAG115XPD	M18™ brushless 115 mm angle grinder with paddle switch	25	M18 BLSAG115XPD-0	No batteries supplied, No charger supplied, No kitbox or bag supplied	Quick release safety guard, cutting guard clip, side handle, flange, flange nut, spanner	4933492647	4058546413972
M18 BLSAG125X	M18™ brushless 125 mm angle grinder with slide switch	25	M18 BLSAG125X-0	No batteries supplied, No charger supplied, No kitbox or bag supplied	Quick release safety guard, cutting guard clip, side handle, flange, flange nut, spanner	4933492643	4058546413934
			M18 BLSAG125X-402X	2 x M18 B4 Battery packs, M12-18 C Charger, HD Box	Quick release safety guard, cutting guard clip, side handle, flange, flange nut, spanner	4933492644	4058546413941
M18 BLSAG125XPD	M18™ brushless 125 mm angle grinder with paddle switch	25	M18 BLSAG125XPD-0	No batteries supplied, No charger supplied, No kitbox or bag supplied	Quick release safety guard, cutting guard clip, side handle, flange, flange nut, spanner	4933492645	4058546413958
			M18 BLSAG125X-PD-402X	2 x M18 B4 Battery packs, M12-18 C Charger, HD Box	Quick release safety guard, cutting guard clip, side handle, flange, flange nut, spanner	4933492646	4058546413965
M12 FCOT	M12 FUEL™ sub compact multi-material cut-off tool	25	M12 FCOT-0	No batteries supplied, No charger supplied, No kitbox or bag supplied	Diamond tile blade, carbide abrasive blade, metal cut-off wheel, adjustable dust shoe	4933464618	4058546225636
			M12 FCOT-422X	1 x M12 B4, 1 x M12 B2 Battery packs, C12 C Charger, HD Box	Diamond tile blade, carbide abrasive blade, metal cut-off wheel, adjustable dust shoe	4933464619	4058546225643
M18 FHSAG125XB2	M18 FUEL™ high performance 125 mm braking grinder with slide switch	25	M18 FH-SAG125XB2-0X	No batteries supplied, No charger supplied, HD Box	Quick release safety guard, cutting guard clip, side handle, flange, flange nut, spanner	4933493415	4058546482862
			M18 FH-SAG125XB2-802X	2 x M18 FB8 Battery packs, M12-18 FC Charger, HD Box	Quick release safety guard, cutting guard clip, side handle, flange, flange nut, spanner	4933493416	4058546482879
M18 FHSAG125X-PDB2	M18 FUEL™ high performance 125 mm braking grinder with paddle switch	25	M18 FHSAG125X-PDB2-0X	No batteries supplied, No charger supplied, HD Box	Quick release safety guard, cutting guard clip, side handle, flange, flange nut, spanner	4933493417	4058546482886
			M18 FHSAG125X-PDB2-802X	2 x M18 FB8 Battery packs, M12-18 FC Charger, HD Box	Quick release safety guard, cutting guard clip, side handle, flange, flange nut, spanner	4933493418	4058546482893
M18 FHSAG150XB2	M18 FUEL™ high performance 150 mm braking grinder with slide switch	24	M18 FH-SAG150XB2-0X	No batteries supplied, No charger supplied, HD Box	Quick release safety guard, dust screen, side handle, flange, flange nut, spanner	4933493421	4058546482923
M18 FHSAG150X-PDB2	M18 FUEL™ high performance 150 mm braking grinder with paddle switch	24	M18 FHSAG150X-PDB2-0X	No batteries supplied, No charger supplied, HD Box	Quick release safety guard, dust screen, side handle, flange, flange nut, spanner	4933493422	4058546482930
M18 FHSAG0125V-XPDB2	M18 FUEL™ high performance 125 mm braking grinder with variable speed and ONE-KEY™	25	M18 FHSAG0125VX-PDB2-0X	No batteries supplied, No charger supplied, HD Box	Quick release safety guard, cutting guard clip, side handle, flange, flange nut, spanner	4933493419	4058546482909
			M18 FHSAG0125VX-PDB2-802X	2 x M18 FB8 Battery packs, M12-18 FC Charger, HD Box	Quick release safety guard, cutting guard clip, side handle, flange, flange nut, spanner	4933493420	4058546482916
M18 FHSAG0180V-XPDB2	M18 FUEL™ high performance 180 mm braking grinder with variable speed & ONE-KEY™ Gen 2	24	M18 FHSAG0180VX-PDB2-0X	No batteries supplied, No charger supplied, HD Box	Quick release safety guard, dust screen, side handle, flange, flange nut, spanner	4933498942	4058546528119
M18 FH-SAGSV0125X	M18 FUEL™ high performance 125 mm braking grinder with ONE-KEY™ and slide switch	25	M18 FH-SAGSV0125X-0X	No batteries supplied, No charger supplied, HD Box	Quick release safety guard, dust screen, side handle, flange, flange nut, spanner	4933500036	4058546572006
M18 FLAG230XPDB	M18 FUEL™ 230 mm large braking grinder with paddle switch	24	M18 FLAG230X-PDB-0C	No batteries supplied, No charger supplied, Kitbox	Quick release safety guard, AVS side handle, flange, FIXTEC™ nut, 2x dust screens, wrench	4933464114	4058546220594
			M18 FLAG230X-PDB-121C	1 x M18 FB12 Battery pack, M12-18 FC Charger, Kitbox	Quick release safety guard, AVS side handle, flange, FIXTEC™ nut, 2x dust screens, wrench	4933499241	4058546564056
M18 FSAG125X	M18 FUEL™ 125 mm angle grinder with slide switch	24	M18 FSAG125X-0	No batteries supplied, No charger supplied, No kitbox or bag supplied	Quick release safety guard, cutting guard clip, AVS side handle, flange, flange nut, spanner, dust screen	4933478701	4058546348946
			M18 FSAG125X-0X	No batteries supplied, No charger supplied, HD Box	Quick release safety guard, cutting guard clip, AVS side handle, flange, flange nut, spanner, dust screen	4933478428	4058546346195

INDEX

Model		Page	Name	Kit included	Standard equipment	Article Number	EAN Code
M18 FSAG125XB	M18 FUEL™ 125 mm braking angle grinder with slide switch	24	M18 FSAG125XB-0	No batteries supplied, No charger supplied, No kitbox or bag supplied	Quick release safety guard, cutting guard clip, AVS side handle, flange, flange nut, spanner, dust screen	4933498062	4058546512224
			M18 FSAG125XB-0X	No batteries supplied, No charger supplied, HD Box	Quick release safety guard, cutting guard clip, AVS side handle, flange, flange nut, spanner, dust screen	4933478429	4058546346201
			M18 FSAG125XB-502X	2 x M18 B5 Battery packs, M12-18 FC Charger, HD Box	Quick release safety guard, cutting guard clip, AVS side handle, flange, flange nut, spanner, dust screen	4933478430	4058546346218
M18 FSAGF125XB	M18 FUEL™ 125 mm flathead braking angle grinder with slide switch	25	M18 FSAGF125XB-0X	No batteries supplied, No charger supplied, HD Box	Quick release safety guard, AVS side handle, flange, flange nut, spanner, dust screen	4933478438	4058546346294
M18 FSAGF125X-PDB	M18 FUEL™ 125 mm flathead braking angle grinder with paddle switch	25	M18 FSAGF125X-PDB-0X	No batteries supplied, No charger supplied, HD Box	Quick release safety guard, AVS side handle, flange, flange nut, spanner, dust screen	4933478439	4058546346300
M18 FSAGSV0125X	M18 FUEL™ 125 mm safety grinder with variable speed and ONE-KEY™	25	M18 FSAGSV0125X-0X	No batteries supplied, No charger supplied, HD Box	Quick release safety guard, cutting guard clip, flange, flange nut, spanner	4933493552	4058546484231
			M18 FSAGSV0125X-502X	2 x M18 B5 Battery packs, M12-18 FC Charger, HD Box	Quick release safety guard, cutting guard clip, flange, flange nut, spanner	4933493553	4058546484248
M18 FSAGV125XB	M18 FUEL™ 125 mm variable speed & braking angle grinder with slide switch	24	M18 FSAGV125XB-0	No batteries supplied, No charger supplied, No kitbox or bag supplied	Quick release safety guard, cutting guard clip, AVS side handle, flange, flange nut, spanner, dust screen	4933499158	4058546530273
			M18 FSAGV125XB-0X	No batteries supplied, No charger supplied, HD Box	Quick release safety guard, cutting guard clip, AVS side handle, flange, flange nut, spanner, dust screen	4933478436	4058546346270
M18 FSAGV125X-PDB	M18 FUEL™ 125 mm variable speed & braking angle grinder with paddle switch	24	M18 FSAGV125X-PDB-0X	No batteries supplied, No charger supplied, HD Box	Quick release safety guard, cutting guard clip, AVS side handle, flange, flange nut, spanner, dust screen	4933478437	4058546346287
M18 ONEF-LAG230XPDB	M18 FUEL™ ONE-KEY™ 230 mm braking angle grinder with paddle switch	24	M18 ONEFLAG230X-PDB-0	No batteries supplied, No charger supplied, No kitbox or bag supplied	Quick release safety guard, cutting guard clip, AVS side handle, flange, flange nut, spanner, dust screen	4933478781	4058546360634
			M18 ONEFLAG230X-PDB-0C	No batteries supplied, No charger supplied, Kitbox	Quick release safety guard, cutting guard clip, AVS side handle, flange, flange nut, spanner, dust screen	4933478782	4058546360641
			M18 ONEFLAG230X-PDB-122C	2 x M18 FB12 Battery packs, M12-18 FC Charger, Kitbox	Quick release safety guard, cutting guard clip, AVS side handle, flange, flange nut, spanner, dust screen	4933499242	4058546564063
M18 ONEF-SAG125XB	M18 FUEL™ ONE-KEY™ 125 mm braking angle grinder with slide switch	24	M18 ONEF-SAG125XB-0X	No batteries supplied, No charger supplied, HD Box	Quick release safety guard, cutting guard clip, AVS side handle, flange, flange nut, spanner, dust screen	4933478433	4058546346249
M18 ONEFSAG125X-PDB	M18 FUEL™ ONE-KEY™ 125 mm braking angle grinder with paddle switch	25	M18 ONEFSAG125X-PDB-0X	No batteries supplied, No charger supplied, HD Box	Quick release safety guard, cutting guard clip, AVS side handle, flange, flange nut, spanner, dust screen	4933478434	4058546346256
			M18 ONEFSAG125X-PDB-502X	2 x M18 B5 Battery packs, M12-18 FC Charger, HD Box	Quick release safety guard, cutting guard clip, AVS side handle, flange, flange nut, dust screen, spanner	4933478435	4058546346263
Automotive inspection cameras							
M12 APB	M12™ automotive premium borescope	41	M12 APB-0C	No batteries supplied, No charger supplied, Kitbox	1 x 5.0 mm/ 150 cm digital camera cable, 1 x 32 GB micro SD card	4932492937	4058546478087
M12 ATB	M12™ automotive technician borescope	41	M12 ATB-0C	No batteries supplied, No charger supplied, Kitbox	1 x 5.0 mm/ 90 cm digital camera cable, 1 x 32 GB micro SD card	4933501239	4058546639556
Band saws							
BS 125	Deep cut band saw	29	BS 125	-	Blade 14 Tpi	4933448245	4002395262830
M12 BS	M12™ sub compact bandsaw	29	M12 BS-0	No batteries supplied, No charger supplied, No kitbox or bag supplied	Blade 18 Tpi	4933431310	4002395242092
			M12 BS-402C	2 x M12 B4 Battery packs, C12 C Charger, Kitbox	Blade 18 Tpi	4933441805	4002395002344
M12 FBS64	M12 FUEL™ sub compact band saw with 64 mm cutting capacity	29	M12 FBS64-0C	No batteries supplied, No charger supplied, Kitbox	Blade 14 Tpi	4933478440	4058546346317
			M12 FBS64-402C	2 x M12 B4 Battery packs, C12 C Charger, Kitbox	Blade 14 Tpi	4933478441	4058546346324
M18 FBS127	M18 FUEL™ deep cut band saw Gen 2	29	M18 FBS127-0	No batteries supplied, No charger supplied, No kitbox or bag supplied	Blade 14 Tpi	4933498309	4058546521783
			M18 FBS127-502C	2 x M18 B5 Battery packs, M12-18 FC Charger, Kitbox	Blade 14 Tpi	4933498310	4058546521790
M18 FBS127DO	M18 FUEL™ dual-trigger deep cut band saw with ONE-KEY™	29	M18 FBS127DO-0C	No batteries supplied, No charger supplied, Kitbox	Blade 14 Tpi	4933498311	4058546521806
M18 FBS85	M18 FUEL™ compact band saw	29	M18 FBS85-0C	No batteries supplied, No charger supplied, Kitbox	Band saw covers, 14 TPI premium blade	4933471496	4058546293956
			M18 FBS85-202C	2 x M18 B2 Battery packs, M12-18 FC Charger, Kitbox	Band saw covers, 14 TPI premium blade	4933471497	4058546293963
Batteries							
L4 B3	3.0 Ah REDLITHIUM™ USB battery	73	L4 B3	-	-	4933478311	4058546345020

Model		Page	Name	Kit included	Standard equipment	Article Number	EAN Code
M12 B2	M12™ 2.0 Ah battery	73	M12 B2	-	-	4932430064	4002395377251
M12 B3	M12™ 3.0 Ah battery	73	M12 B3	-	-	4932451388	4002395157969
M12 B4	M12™ 4.0 Ah battery	73	M12 B4	-	-	4932430065	4002395377268
M12 B6	M12™ 6.0 Ah battery	73	M12 B6	-	-	4932451395	4002395158638
M12 HB2.5	M12™ HIGH OUTPUT™ 2.5 Ah battery	73	M12 HB2.5	-	-	4932480164	4058546404499
M12 HB5	M12™ HIGH OUTPUT™ 5.0 Ah Battery	72	M12 HB5	-	-	4932480165	4058546404505
M18 B2	M18™ 2.0 Ah battery	72	M18 B2	-	-	4932430062	4002395377237
M18 B4	M18™ 4.0 Ah battery	72	M18 B4	-	-	4932430063	4002395377244
M18 B5	M18™ 5.0 Ah battery	73	M18 B5	-	-	4932430483	4002395381449
			M18 B52	-	-	4932451242	4002395166237
M18 B5-CR	M18™ resistant 5.0 Ah battery	72	M18 B5-CR	-	-	4932479265	4058546370596
M18 FB12	M18™ FORGE™ 12.0 Ah battery	73	M18 FB12	-	-	4932492651	4058546414016
M18 FB6	M18™ FORGE™ 6.0 Ah Battery	73	M18 FB6	-	-	4932492533	4058546419004
M18 FB8	M18™ FORGE™ 8.0 Ah battery	73	M18 FB8	-	-	4932492131	4058546414986
M18 HB3	M18™ HIGH OUTPUT™ 3.0 Ah battery	73	M18 HB3	-	-	4932471069	4058546286972
M18 HB5.5	M18™ HIGH OUTPUT™ 5.5 Ah battery	73	M18 HB5.5	-	-	4932464712	4058546226572
MXF CP203	MX FUEL™ REDLITHIUM™ 3.0 Ah battery	72	MXF CP203	-	-	4933471838	4058546297374
			MXF CP-2203	-	-	4933479161	4058546369552
MXF HD812	MX FUEL™ FORGE™ 12.0 Ah battery	72	MXF HD812	-	-	4932492128	4058546414955
MXF PBE	MX FUEL™ portable battery extension	72	MXF PBE-0	-	-	4933498067	4058546512279
MXF XC406	MX FUEL™ REDLITHIUM™ 6.0 Ah battery	72	MXF XC406	-	-	4933471837	4058546297367
			MXF XC-2406	-	-	4933479162	4058546369569
MXF XC608	MX FUEL™ FORGE™ 8.0 Ah battery	72	MXF XC608	-	-	4932492130	4058546414979
Blowers							
M18 BLBL0	M18™ brushless blower	58	M18 BLBL0-0	No batteries supplied, No charger supplied, No kitbox or bag supplied	-	4933500239	4058546615413
M18 F2BL	M18 FUEL™ dual battery blower	58	M18 F2BL-0	No batteries supplied, No charger supplied, No kitbox or bag supplied	Tapered nozzle, flat nozzle	4933479987	4058546377816
			M18 F2BL-802	2 x M18 FB8 Battery packs, M18 DBSC Charger, No kitbox or bag supplied	Tapered nozzle, flat nozzle	4933499229	4058546563936
M18 F2BPB	M18 FUEL™ dual battery backpack blower	58	M18 F2BPB-0	No batteries supplied, No charger supplied, No kitbox or bag supplied	Tapered nozzle, flat nozzle	4933493212	4058546480837
			M18 F2BPB-124	4 x M18 FB12 Battery packs, M18 PC6 Charger, No kitbox or bag supplied	Tapered nozzle, flat nozzle	4933499231	4058546563950
M18 FBLG3	M18 FUEL™ blower	58	M18 FBLG3-0	No batteries supplied, No charger supplied, No kitbox or bag supplied	-	4933493301	4058546481728
			M18 FBLG3-802	2 x M18 FB8 Battery packs, M12-18 FC Charger, No kitbox or bag supplied	-	4933499233	4058546563974
M18 FOPH-BA	QUIK-LOK™ blower attachment	58	M18 FOPH-BA	-	-	4932492668	4058546475390
MXF BPB	MX FUEL™ backpack blower	58	MXF BPB-0	No batteries supplied, No charger supplied, No kitbox or bag supplied	1 x backpack harness and hip-belt, 2 x blowing nozzles	4933500235	4058546615376
			MXF BPB-122	2 x MXF HD812 Battery packs, MXF SC Charger, No kitbox or bag supplied	1 x backpack harness and hip-belt, 2 x blowing nozzles	4933500236	4058546615383
Blowers and fans for job site							
M12 AF	M12™ air fan	39	M12 AF-0	No batteries supplied, No charger supplied, No kitbox or bag supplied	-	4933478228	4058546344054
M12 BBL	M12™ blower	39	M12 BBL-0	No batteries supplied, No charger supplied, No kitbox or bag supplied	Extension nozzle, rubber nozzle, square nozzle	4933472214	4058546326104

INDEX

Model		Page	Name	Kit included	Standard equipment	Article Number	EAN Code
M18 AFG2	M18™ air fan	39	M18 AFG2-0	No batteries supplied, No charger supplied, No kitbox or bag supplied	2 m cable	4933493443	4058546483142
M18 ARFHP	M18™ high performance air fan	39	M18 ARFHP-0	No batteries supplied, No charger supplied, No kitbox or bag supplied	2 m cable	4933492110	4058546414771
M18 BBL	M18™ battery blower	39	M18 BBL-0	No batteries supplied, No charger supplied, No kitbox or bag supplied	Nozzle extension (228.6 mm), universal inflator/deflator attachment	4933446216	4002395004942
M18 BLHSB	M18™ brushless high speed blower	39	M18 BLHSB-0	No batteries supplied, No charger supplied, No kitbox or bag supplied	Inlet filter, 6 mm nozzle, 10 mm nozzle, inflator nozzle, nozzle holder	4933500533	4058546618353
Cable cutting							
M12 CC	M12™ sub compact cable cutter	45	M12 CC-0	No batteries supplied, No charger supplied, No kitbox or bag supplied	-	4933431600	4002395242832
M18 HCC125	M18™ FORCE LOGIC™ hydraulic 125 mm cable cutter	45	M18 HCC125-801C	1 x M18 FB8 Battery pack, M12-18 FC Charger, Kitbox	-	4933499333	4058546564971
M18 HCC45	M18™ FORCE LOGIC™ hydraulic 44 mm cable cutter	44	M18 HCC45-0C	No batteries supplied, No charger supplied, Kitbox	-	4933459265	4058546002312
			M18 HCC45-522C	1 x M18 B5, 1 x M18 B2 Battery packs, M12-18 FC Charger, Kitbox	-	4933459266	4058546002329
M18 HCC75	M18™ FORCE LOGIC™ hydraulic underground cable cutter	45	M18 HCC75-0C	No batteries supplied, No charger supplied, Kitbox	-	4933459268	4058546002343
			M18 HCC75-502C	2 x M18 B5 Battery packs, M12-18 FC Charger, Kitbox	-	4933459269	4058546002350
M18 HCC75R	M18™ FORCE LOGIC™ hydraulic remote underground cable cutter	44	M18 HCC75R-502C	2 x M18 B5 Battery packs, M12-18 FC Charger, Kitbox	Remote control	4933459271	4058546002374
M18 HSFC125R	M18™ FORCE LOGIC™ hydraulic 125 mm safety cable cutter	45	M18 HSFC125R-802C	2 x M18 FB8 Battery packs, M12-18 FC Charger, Kitbox	Remote control	4933499331	4058546564957
M18 ONEHCC	M18™ FORCE LOGIC™ hydraulic 35 mm cable cutter	44	M18 ONEHCC-0C ACSR SET	No batteries supplied, No charger supplied, Kitbox	ACSR jaw	4933464303	4058546222482
			M18 ONEHCC-201C ACSR SET	1 x M18 B2 Battery pack, M12-18 C Charger, Kitbox	ACSR jaw	4933464304	4058546222499
			M18 ONEHCC-0C CU/AL-SET	No batteries supplied, No charger supplied, Kitbox	Cu/AL jaw	4933464300	4058546222451
			M18 ONEHCC-201C CU/AL-SET	1 x M18 B2 Battery pack, M12-18 C Charger, Kitbox	Cu/AL jaw	4933464301	4058546222468
			M18 ONEHCC-0C FSW SET	No batteries supplied, No charger supplied, Kitbox	FSW jaw	4933464308	4058546222536
			M18 ONEHCC-0C SWA SET	No batteries supplied, No charger supplied, Kitbox	SWA jaw	4933464306	4058546222512
			M18 ONEHCC-201C FSW SET	1 x M18 B2 Battery pack, M12-18 C Charger, Kitbox	FSW jaw	4933464309	4058546222543
Cable connecting							
M18 BSBT	M18™ shear bolt tool	47	M18 BSBT-0X	No batteries supplied, No charger supplied, HD Box	9 x impact rated 1/2" sockets (10/ 17 mm socket, 13/ 19 mm socket long, 5/ 6/ 8 mm Hex socket, 6/ 8 mm Hex socket long), 2 x fork attachment (33-52 mm, 58-69 mm)	4933493288	4058546481599
			M18 BSBT-202X	2 x M18 B2 Battery packs, M12-18 FC Charger, HD Box	9 x impact rated 1/2" sockets (10/ 17 mm socket, 13/ 19 mm socket long, 5/ 6/ 8 mm Hex socket, 6/ 8 mm Hex socket long), 2 x fork attachment (33-52 mm, 58-69 mm)	4933493289	4058546481605
Cable crimping							
M18 HCCT	M18™ FORCE LOGIC™ hydraulic 53 kN cable crimper	44	M18 HCCT-201C	1 x M18 B2 Battery pack, M12-18 C Charger, Kitbox	Crimping jaw	4933451194	4002395138821
M18 HCCT109/42	M18™ FORCE LOGIC™ hydraulic 109 kN cable crimper	44	M18 HCCT109/42-522C	1 x M18 B5, 1 x M18 B2 Battery packs, M12-18 FC Charger, Kitbox	-	4933459273	4058546002398
M18 HDCT	M18™ FORCE LOGIC™ hydraulic dieless crimper	44	M18 HDCT-0C	No batteries supplied, No charger supplied, Kitbox	-	4933471949	4058546298487
			M18 HDCT-202C	2 x M18 B2 Battery packs, M12-18 C Charger, Kitbox	-	4933471950	4058546298494
M18 ONEHCCT60	M18™ FORCE LOGIC™ hydraulic 60 kN cable crimper	44	M18 ONEHCCT60-0C	No batteries supplied, No charger supplied, Kitbox	-	4933479683	4058546374778
			M18 ONEHCCT60-202C	2 x M18 B2 Battery packs, M12-18 C Charger, Kitbox	-	4933479684	4058546374785
Cable pulling							
M18 FPFT	M18 FUEL™ powered fish tape	47	M18 FPFT-0	No batteries supplied, No charger supplied, No kitbox or bag supplied	-	4933471952	4058546298517
			M18 FPFT-202 30m NC Set	2 x M18 B2 Battery packs, M12-18 FC Charger, No kitbox or bag supplied	30 m non-conductive tape drum	4933471954	4058546298531
			M18 FPFT-202 36m ST Set	2 x M18 B2 Battery packs, M12-18 FC Charger, No kitbox or bag supplied	36 m x 3 mm steel tape drum	4933471953	4058546298524

Model		Page	Name	Kit included	Standard equipment	Article Number	EAN Code
Cable stripping							
M18 FCST	M18 FUEL™ cable stripping tool	47	M18 FCST-0C	No batteries supplied, No charger supplied, Kitbox	Allen key, depth gauge, cable size gauge, handle	4933499274	4058546564384
			M18 FCST-302CA	2 x M18 HB3 Battery packs, M12-18 FC Charger, Kitbox	Allen key, depth gauge, cable size gauge, replacement blade, handle, 6 x stripping heads	4933499275	4058546564391
Carts, Trolleys, Stands							
BRT	Breaker trolley	13	BRT	-	-	4933459794	4058546029661
MXF COSCG2	MX FUEL™ cut-off saw cart	13	MXF COSCG2	-	-	4932501120	4058546624224
MXF DHT	Breaker trolley for MX FUEL™ demolition hammer	13	MXF DHT	-	-	4933464879	4058546228248
MXF DR255TV	Premium diamond drilling stand for MX FUEL™ diamond core drill MXF DCD150	13	MXF DR255TV	-	Concrete fixing kit (4932399731), vacuum rubber seal, 17 x 19 wrench, 6 mm hex key, 8 mm hex key, universal 60 mm quick connect motor bracket	4933472247	4058546338930
Chain hoist							
M18 BLCHTO	M18™ brushless 1 ton chain hoist with ONE-KEY™	13	M18 BLCHTO-121	1 x M18 FB12 Battery pack, M12-18 FC Charger, No kitbox or bag supplied	6 m chain, chain bag	4933500224	4058546615260
Chain saws, pruning saws, telescopic pole saw							
M12 FHS	M12 FUEL™ HATCHET™ pruning saw 15 cm	57	M12 FHS-0	No batteries supplied, No charger supplied, No kitbox or bag supplied	1x Oregon 15 cm (6") bar and chain, 1 x scabbard, 1 x scrench	4933472211	4058546326074
			M12 FHS-602X	2 x M12 B6 Battery packs, C12 C Charger, HD Box	1x Oregon 15 cm (6") bar and chain, 1 x scabbard, 1 x scrench	4933472212	4058546326081
M18 F2CHS50	M18 FUEL™ dual battery chainsaw 50 cm	56	M18 F2CHS50-0	No batteries supplied, No charger supplied, No kitbox or bag supplied	76cc of oil, chain tool, bar cover	4933480120	4058546404055
			M18 F2CHS50-802	2 x M18 FB8 Battery packs, M18 DFC Charger, No kitbox or bag supplied	76cc of oil, chain tool, bar cover	4933480121	4058546404062
M18 FCHS	M18 FUEL™ chainsaw with 40 cm bar	56	M18 FCHS-0	No batteries supplied, No charger supplied, No kitbox or bag supplied	76cc of oil, chain tool, bar cover	4933464723	4058546226688
			M18 FCHS-122	2 x M18 FB12 Battery packs, M12-18 FC Charger, No kitbox or bag supplied	76cc of oil, chain tool, bar cover	4933499217	4058546563813
M18 FCHS35	M18 FUEL™ chainsaw with 35 cm bar	56	M18 FCHS35-0	No batteries supplied, No charger supplied, No kitbox or bag supplied	76cc of oil, chain tool, bar cover	4933479678	4058546374723
			M18 FCHS35-122	2 x M18 FB12 Battery packs, M12-18 FC Charger, No kitbox or bag supplied	76cc of oil, chain tool, bar cover	4933499223	4058546563875
M18 FCHSC	M18 FUEL™ chainsaw with 30 cm bar	56	M18 FCHSC-0	No batteries supplied, No charger supplied, No kitbox or bag supplied	76cc of oil, chain tool, bar cover	4933471441	4058546290696
			M18 FCHSC-122	2 x M18 FB12 Battery packs, M12-18 FC Charger, No kitbox or bag supplied	76cc of oil, chain tool, bar cover	4933499219	4058546563837
M18 FHS20	M18 FUEL™ HATCHET™ pruning saw 20 cm	57	M18 FHS20-0	No batteries supplied, No charger supplied, No kitbox or bag supplied	1x 20 cm (8") bar and chain, 1x scabbard, 1x scrench	4933480117	4058546404024
			M18 FHS20-552	2 x M18 HB5.5 Battery packs, M12-18 FC Charger, No kitbox or bag supplied	1x 20 cm (8") bar and chain, 1x scabbard, 1x scrench	4933480118	4058546404031
M18 FOPH-CSA	QUIK-LOK™ chainsaw attachment	57	M18 FOPH-CSA	-	Blade guard	4932464957	4058546229023
M18 FTHCHS30	M18 FUEL™ top handle chainsaw with 30 cm bar	57	M18 FTHCHS30-0	No batteries supplied, No charger supplied, No kitbox or bag supplied	76cc of oil, chain tool, bar cover	4933479586	4058546373801
			M18 FTHCHS30-802	2 x M18 FB8 Battery packs, M12-18 FC Charger, No kitbox or bag supplied	76cc of oil, chain tool, bar cover	4933499221	4058546563851
M18 FTHCHS35	M18 FUEL™ top handle chainsaw with 35 cm bar	57	M18 FTHCHS35-0	No batteries supplied, No charger supplied, No kitbox or bag supplied	76cc of oil, chain tool, bar cover	4933479588	4058546373825
			M18 FTHCHS35-802	2 x M18 FB8 Battery packs, M12-18 FC Charger, No kitbox or bag supplied	76cc of oil, chain tool, bar cover	4933499222	4058546563868
M18 FTSP30	M18 FUEL™ telescopic pole saw 30 cm	57	M18 FTSP30-0	No batteries supplied, No charger supplied, No kitbox or bag supplied	76cc of oil, chain tool, bar cover	4933480868	4058546411534
			M18 FTSP30-121	1 x M18 FB12 Battery pack, M12-18 FC Charger, No kitbox or bag supplied	76cc of oil, chain tool, bar cover	4933499227	4058546563912
Chargers							
C12 C	M12™ charger	75	C12 C	-	-	4932352000	4002395366606
M12-18 AC	M12™-M18™ car charger	74	M12-18 AC	-	-	4932459205	4002395287208
M12-18 C	M12™ - M18™ charger	74	M12-18 C	-	-	4932352959	4002395376179
M12-18 FC	M12™ - M18™ fast charger	74	M12-18 FC	-	-	4932451079	4002395810581

INDEX

Model		Page	Name	Kit included	Standard equipment	Article Number	EAN Code
M12-18 GBC4	M12™ - M18™ gangbox charger	75	M12-18 GBC4	-	-	4933493863	4058546510237
M12 C4	M12™ 4 bay charger	75	M12 C4	-	-	4932430554	4002395382156
M12 TC2	M12™ compact charger and power source 2	75	M12 TC2-0	No batteries supplied, No charger supplied, No kitbox or bag supplied	-	4932492908	4058546477790
M1418C6	M14™ - M18™ multibay charger	74	M1418 C6	-	-	4932430086	4002395377473
M18 DBSC	M18™ dual bay super charger	75	M18 DBSC	-	-	4932492531	4058546418984
M18 DFC	M18™ dual bay rapid charger	75	M18 DFC	-	-	4932472073	4058546324698
M18 MDBSC	M18™ mobile dual bay super charger	75	M18 MDBSC	-	-	4932498557	4058546524265
M18 MPC6	M18™ mobile PACKOUT™ six bay rapid charger	74	M18 MPC6	-	-	4932498551	4058546524203
M18 PC6	M18™ PACKOUT™ six bay rapid charger	75	M18 PC6	-	-	4932480162	4058546404475
M18 TC	M18™ TOP-OFF mini charger	75	M18 TC	No batteries supplied, No charger supplied, No kitbox or bag supplied	-	4932499165	4058546530341
MXF C	MX FUEL™ charger	74	MXF C	-	-	4933471839	4058546297381
MXF FC	MX FUEL™ fast charger	74	MXF FC	-	-	4933498547	4058546524166
MXF SC	MX FUEL™ super charger	74	MXF SC	-	-	4932492848	4058546477196
Compactors							
MXF PC50	MX FUEL™ plate compactor		MXF PC50-0	No batteries supplied, No charger supplied, No kitbox or bag supplied	-	4933493267	4058546481384
		4	MXF PC50-122	2 x MXF HD812 Battery packs, MXF SC Charger, No kitbox or bag supplied	-	4933493268	4058546481391
MXF RAM60	MX FUEL™ rammer	4	MXF RAM60-0	No batteries supplied, No charger supplied, No kitbox or bag supplied	-	4933498158	4058546513184
			MXF RAM60-122	2 x MXF HD812 Battery packs, MXF SC Charger, No kitbox or bag supplied	-	4933498159	4058546513191
Concrete vibrators							
M18 FCVN	M18 FUEL™ needle concrete vibrator	4	M18 FCVN12-0	No batteries supplied, No charger supplied, No kitbox or bag supplied	-	4933479596	4058546373900
			M18 FCVN24-0	No batteries supplied, No charger supplied, No kitbox or bag supplied	-	4933479599	4058546373931
			M18 FCVN24-551	1 x M18 HB5.5 Battery pack, M12-18 FC Charger, No kitbox or bag supplied	-	4933479600	4058546373948
			M18 FCVN12-551	1 x M18 HB5.5 Battery pack, M12-18 FC Charger, No kitbox or bag supplied	-	4933479597	4058546373917
MXF CVBC	MX FUEL™ briefcase concrete vibrator	4	MXF CVBC-0	No batteries supplied, No charger supplied, No kitbox or bag supplied	Remote control	4933479607	4058546374013
			MXF CVBC-602	2 x MXF XC406 Battery packs, MXF C Charger, No kitbox or bag supplied	Remote control	4933479608	4058546374020
			MXF CVBCKIT-602	2 x MXF XC406 Battery packs, MXF C Charger, No kitbox or bag supplied	Remote control, 4 m vibrator shaft, 38 mm vibrator head	4933479610	4058546374044
MXF CVBP	MX FUEL™ backpack concrete vibrator	4	MXF CVBP-0	No batteries supplied, No charger supplied, No kitbox or bag supplied	Remote control	4933479595	4058546373894
			MXF CVBP-602	2 x MXF XC406 Battery packs, MXF C Charger, No kitbox or bag supplied	Remote control	4933479591	4058546373856
			MXF CVBPKIT-602	2 x MXF XC406 Battery packs, MXF C Charger, No kitbox or bag supplied	Remote control, 2 m vibrator shaft, 38 mm vibrator head	4933479593	4058546373870
MXF CVHF	MX FUEL™ high frequency concrete vibrator	4	MXF CVHF-0	No batteries supplied, No charger supplied, No kitbox or bag supplied	Remote control	4933498132	4058546512927
			MXF CVHF-802	2 x MXF XC608 Battery packs, MXF SC Charger, No kitbox or bag supplied	Remote control	4933498133	4058546512934
Construction tools - grinders with dust management, wall chasers, impact wrenches, paddle mixer							
AGV 12 DEC	1200 W angle grinder with dust management (28 mm DOC)	14	AGV 12-125 X DEC-SET	-	Quick release safety guard, AVS side handle, dust extraction cutting shroud, diamond cutting wheel DUH 125 mm, flange, flange nut, spanner, 4 m cable	4933448020	4002395006809
AGV 12 DEG	1200 W angle grinder with dust management	14	AGV 12-125 X DEG-SET	-	Quick release safety guard, bale handle, dust extraction grinding shroud, diamond cup wheel 125 mm, flange, flange nut, spanner, 4 m cable	4933448030	4002395006823
AGV 15 DEG	1550 W angle grinder with dust management (28 mm DOC)	14	AGV 15-125 XC DEC-SET	-	Quick release safety guard, AVS side handle, dust extraction cutting shroud, diamond cutting wheel DUH 125 mm, flange, flange nut, spanner, 4 m cable	4933448025	4002395006816

Model		Page	Name	Kit included	Standard equipment	Article Number	EAN Code
AGV 15 DEG	1550 W angle grinder with dust management	14	AGV 15-125 XC DEG-SET	-	Quick release safety guard, bale handle, dust extraction grinding shroud, diamond cup wheel 125 mm, flange, flange nut, spanner, 4 m cable	4933448035	4002395006830
			AGV 15-125 XE DEG-SET	-	Quick release safety guard, bale handle, dust extraction grinding shroud, diamond cup wheel 125 mm, flange, flange nut, spanner, 4 m cable	4933448830	4002395263424
IPWE 400 R	½" drive impact wrench	15	IPWE 400 R	-	-	4933451524	4002395143511
IPWE 520 R	¾" drive impact wrench	15	IPWE 520 R	-	-	4933451525	4002395143528
M18 FPM	M18 FUEL™ paddle mixer	15	M18 FPM-0X	No batteries supplied, No charger supplied, HD Box	-	4933459719	4058546028916
WCE 30	1500 W 125 mm (30 mm DOC) wall chaser	15	WCE 30	-	2x diamond discs, special chisel, keys, bayonet adaptor	4933383855	4002395228980
WCS 45	1900 W 150 mm (45 mm DOC) wall chaser	15	WCS 45	-	2x diamond discs, special chisel, keys	4933383350	4002395229086
Cut-off saws							
M18 FCOS230	M18 FUEL™ cut-off saw	5	M18 FCOS230-0	No batteries supplied, No charger supplied, No kitbox or bag supplied	DUH 230 mm diamond blade (4932399542)	4933471696	4058546295950
			M18 FCOS230-121	1 x M18 FB12 Battery pack, M12-18 FC Charger, No kitbox or bag supplied	DUH 230 mm diamond blade (4932399542)	4933499175	4058546563394
MXF COS350G2	MX FUEL™ 350 mm cut-off saw	5	MXF COS350G2-0	No batteries supplied, No charger supplied, Contractor Bag	HUDD 350mm SPEEDCROSS™ diamond blade (4932471985)	4933480478	4058546407636
			MXF COS350G2-802	2 x MXF XC608 Battery packs, MXF SC Charger, Contractor Bag	HUDD 350mm SPEEDCROSS™ diamond blade (4932471985)	4933480480	4058546407650
Dedicated dust extractors							
M12 UDEL	M12™ universal dust extractor	12	M12 UDEL-0B	No batteries supplied, No charger supplied, Tool bag	2x nozzles, side handle	4933471460	4058546290887
			M12 UDEL-201B	1 x M12 B2 Battery pack, C12 C Charger, Tool bag	2x nozzles, side handle	4933471461	4058546290894
M18 CDEX	M18 FUEL™ SDS-plus dust extractor	12	M18 CDEX-0	No batteries supplied, No charger supplied, No kitbox or bag supplied	Replacement brush rings	4933447450	4002395006243
M18 FCDDEXL	Compact dedicated dust extraction for M18 FUEL™ 26 mm SDS-Plus hammers	12	M18 FCDDEXL-0	No batteries supplied, No charger supplied, No kitbox or bag supplied	Replacement brush rings	4933478507	4058546347000
M18 FDDEC	M18™ dedicated dust extractor for M18 FUEL™ high performance 4-mode 16 mm SDS-Plus hammer	12	M18 FDDEC-0	No batteries supplied, No charger supplied, No kitbox or bag supplied	Replacement brush rings	4933498587	4058546524562
M18 FDDEL32	Dedicated dust extraction for M18 FUEL™ 32 mm SDS-Plus D-handle hammer with AUTOPULSE™	12	M18 FDDEL32-0	No batteries supplied, No charger supplied, No kitbox or bag supplied	Replacement brush rings	4933492142	4058546415099
M18 FDDEXL	Dedicated dust extraction for M18 FUEL™ 26 mm SDS-Plus hammers with AUTOPULSE™	12	M18 FDDEXL-0	No batteries supplied, No charger supplied, No kitbox or bag supplied	Replacement brush rings	4933478508	4058546347017
M18 FPDDEXL	Dedicated dust extraction for M18 FUEL™ 32 mm SDS-Plus hammers with AUTOPULSE™	12	M18 FPDDEXL-0	No batteries supplied, No charger supplied, No kitbox or bag supplied	Replacement brush rings	4933478509	4058546347024
Diamond drills							
DD 2-160 XE	2-speed dry diamond drill	13	DD 2-160 XE	-	-	4933368690	4002395232505
DD 3-152	3-speed combi diamond drill	13	DD 3-152	-	-	4933428000	4002395239801
MXF DCD150	MX FUEL™ 150 mm diamond core drill	13	MXF DCD150-0C	No batteries supplied, No charger supplied, Kitbox	Trigger lock-on, side handle	4933478986	4058546362683
			MXF DCD150-302C	2 x MXF CP203 Battery packs, MXF C Charger, Kitbox	Trigger lock-on, side handle	4933464887	4058546228323
			MXF DCD150-302C KIT	2 x MXF CP203 Battery packs, MXF C Charger, Kitbox	Trigger lock-on, side handle, MXF DR255TV drill stand	4933471835	4058546297343
MXF DCD350	MX FUEL™ 350 mm diamond core drill	13	MXF DCD350 KIT-0	No batteries supplied, No charger supplied, No kitbox or bag supplied	MXF DCD350 DR rig stand	4933493142	4058546480134
			MXF DCD350 KIT-122	2 x MXF HD812 Battery packs, MXF SC Charger, No kitbox or bag supplied	MXF DCD350 DR rig stand	4933493143	4058546480141
Drain cleaners							
M12 BDC6	M12™ sub compact drain cleaner with spiral diameter 6 mm	51	M12 BDC6-0C	No batteries supplied, No charger supplied, Bucket	6 mm x 7.6 m inner core bulb head	4933451634	4002395141616
			M12 BDC6-202C	2 x M12 B2 Battery packs, C12 C Charger, Bucket	6 mm x 7.6 m inner core bulb head	4933451635	4002395141623
M12 BDC8	M12™ sub compact drain cleaner with spiral diameter 8 mm	51	M12 BDC8-0C	No batteries supplied, No charger supplied, Bucket	8 mm x 7.6 m inner core bulb head	4933451632	4002395140992
			M12 BDC8-202C	2 x M12 B2 Battery packs, C12 C Charger, Bucket	8 mm x 7.6 m inner core bulb head	4933451633	4002395141609

INDEX

Model		Page	Name	Kit included	Standard equipment	Article Number	EAN Code
M18 FDCPF10	M18 FUEL™ drain cleaner - power feed 10 mm	51	M18 FDCPF10-0C	No batteries supplied, No charger supplied, Closed bucket	1 x 10 mm x 10.6 m cable (48532675), retriever bulb, removal pin	4933459684	4058546028565
			M18 FDCPF10-201C	1 x M18 B2 Battery pack, M12-18 FC Charger, Closed bucket	1 x 10 mm x 10.6 m cable (48532675), 5 pc cutter set (48532685), removal pin	4933459685	4058546028572
M18 FDCPF8	M18 FUEL™ drain cleaner - power feed 8 mm	51	M18 FDCPF8-0C	No batteries supplied, No charger supplied, Closed bucket	8 mm x 10.6 m cable (48532673)	4933459683	4058546028558
M18 FFSDC10	M18 FUEL™ free standing drain cleaner 10 mm	50	M18 FFSDC10-0	No batteries supplied, No charger supplied, No kitbox or bag supplied	1 x backpack assembly, 1 x drum assembly, 1 x 10 mm x 15 m cables, 1 x cutter set & removal tool	4933459707	4058546028794
M18 FFSDC13	M18 FUEL™ free standing drain cleaner 13 mm	50	M18 FFSDC13-0	No batteries supplied, No charger supplied, No kitbox or bag supplied	1 x backpack assembly, 2 x drum assembly's, 2 x 13 mm x 15 m cables, 1 x cutter set & removal tool	4933459708	4058546028800
M18 FFSDC16	M18 FUEL™ free standing drain cleaner 16 mm	50	M18 FFSDC16-0	No batteries supplied, No charger supplied, No kitbox or bag supplied	1 x backpack assembly, 2 x drum assembly's, 2 x 16 mm x 15 m cables, 1 x cutter set & removal tool	4933459709	4058546028817
			M18 FFSDC16-502	2 x M18 B5 Battery packs, M12-18 FC Charger, No kitbox or bag supplied	1 x backpack assembly, 2 x drum assembly's, 2 x 16 mm x 15 m cables, 1 x cutter set & removal tool	4933459710	4058546028824
MXF LSDP	MX FUEL™ large sewer drum machine with POWERREDZ™	50	MXF LSDP-301	1 x MXF CP203 Battery pack, MXF C Charger, No kitbox or bag supplied	1 x 20 mm x 15.2 m inner core cable, 1 x 20 mm x 7.6 m inner core cable, 1 x 9 pc head attachment kit	4933471851	4058546297503
Drill drivers							
M12 BDDX	M12™ sub compact drill driver with removable chuck	17	M12 BDDXKIT-202C	2 x M12 B2 Battery packs, C12 C Charger, Kitbox	Removable FIXTEC™ chuck, offset attachment, right angle drill attachment, belt clip, 25 mm P22 bit	4933447836	4002395006595
M12 BLDDRC	M12™ compact brushless drill driver	17	M12 BLDDRC-0	No batteries supplied, No charger supplied, No kitbox or bag supplied	Belt clip	4933499683	4058546568474
			M12 BLDDRC-202C	2 x M12 B2 Battery packs, C12 C Charger, Kitbox	Belt clip	4933499686	4058546568504
			M12 BLDDRC-402C	2 x M12 B4 Battery packs, C12 C Charger, Kitbox	Belt clip	4933499688	4058546568528
M12 FDD2	M12 FUEL™ sub compact drill driver	17	M12 FDD2-0	No batteries supplied, No charger supplied, No kitbox or bag supplied	Belt clip and bit holder	4933479872	4058546376666
			M12 FDD2-202X	2 x M12 B2 Battery packs, C12 C Charger, HD Box	Belt clip and bit holder	4933479873	4058546376673
			M12 FDD2-402X	2 x M12 B4 Battery packs, C12 C Charger, HD Box	Belt clip and bit holder	4933479874	4058546376680
			M12 FDD2-602X	2 x M12 B6 Battery packs, C12 C Charger, HD Box	Belt clip and bit holder	4933479875	4058546376697
M12 FDDX	M12 FUEL™ installation drill/driver with interchangeable heads	17	M12 FDDX-0	No batteries supplied, No charger supplied, No kitbox or bag supplied	10 mm metal chuck	4933464978	4058546229238
			M12 FDDXKIT-0X	No batteries supplied, No charger supplied, HD Box	10 mm metal chuck, right angle attachment, offset attachment and 6 mm hex attachment	4933471332	4058546289607
			M12 FDDXKIT-202X	2 x M12 B2 Battery packs, C12 C Charger, HD Box	10 mm metal chuck, right angle attachment, offset attachment and 6 mm hex attachment	4933464979	4058546229245
M18 BLDD2	M18™ brushless drill driver	16	M18 BLDD2-0X	No batteries supplied, No charger supplied, HD Box	Belt clip, side handle	4933464514	4058546224592
			M18 BLDD2-402X	2 x M18 B4 Battery packs, M12-18 C Charger, HD Box	Belt clip, side handle	4933464559	4058546225049
			M18 BLDD2-502X	2 x M18 B5 Battery packs, M12-18 FC Charger, HD Box	Belt clip, side handle	4933464515	4058546224608
M18 BLDDRC	M18™ compact brushless drill driver	17	M18 BLDDRC-0	No batteries supplied, No charger supplied, No kitbox or bag supplied	Belt clip and bit holder	4933492831	4058546477028
			M18 BLDDRC-0X	No batteries supplied, No charger supplied, HD Box	Belt clip and bit holder	4933492832	4058546477035
			M18 BLDDRC-202C	2 x M18 B2 Battery packs, M12-18 C Charger, Kitbox	Belt clip and bit holder	4933492833	4058546477042
			M18 BLDDRC-402C	2 x M18 B4 Battery packs, M12-18 C Charger, Kitbox	Belt clip and bit holder	4933492834	4058546477059
			M18 BLDDRC-502C	2 x M18 B5 Battery packs, M12-18 C Charger, Kitbox	Belt clip and bit holder	4933492835	4058546477066
M18 FDD3	M18 FUEL™ drill driver	16	M18 FDD3-0	No batteries supplied, No charger supplied, No kitbox or bag supplied	Belt clip, side handle	4933498059	4058546512194
			M18 FDD3-0X	No batteries supplied, No charger supplied, HD Box	Belt clip, side handle	4933479862	4058546376567
			M18 FDD3-402C	2 x M18 B4 Battery packs, M12-18 C Charger, Kitbox	Belt clip, side handle	4933492472	4058546418397
			M18 FDD3-502X	2 x M18 B5 Battery packs, M12-18 FC Charger, HD Box	Belt clip, side handle	4933479863	4058546376574
M18 ONEDD3	M18 FUEL™ ONE-KEY™ drill driver	16	M18 ONEDD3-0X	No batteries supplied, No charger supplied, HD Box	Belt clip, side handle	4933492799	4058546476700
			M18 ONEDD3-502X	2 x M18 B5 Battery packs, M12-18 FC Charger, HD Box	Belt clip, side handle	4933492802	4058546476731

Model		Page	Name	Kit included	Standard equipment	Article Number	EAN Code
Drill press							
M18 FMDP	M18 FUEL™ magnetic drilling press with permanent magnet	17	M18 FMDP-0C	No batteries supplied, No charger supplied, Kitbox	Lubrication tank with hose, magnetic lubrication tank holder, 13 mm chuck with Weldon adaptor, chuck key, ejector pin, safety strap	4933451636	4002395142330
			M18 FMDP-502C	2 x M18 B5 Battery packs, M12-18 FC Charger, Kitbox	Lubrication tank with hose, magnetic lubrication tank holder, 13 mm chuck with Weldon adaptor, chuck key, ejector pin, safety strap	4933451012	4002395136650
MDE 41	Magnetic drilling press with electro magnet	17	MDE 41	-	Spray can, 13 mm chuck with Weldon adaptor, chuck key, ejector pin, safety strap	4933451015	4002395136681
MDP 41	Magnetic drilling press with permanent magnet	17	MDP 41	-	Spray can, 13 mm chuck with Weldon adaptor, chuck key, ejector pin, safety strap	4933451014	4002395136674
Dust extractors							
AS 2-250EH	25 l H-class dust extractor	38	AS 2-250EH	-	4 m hose, floor cleaning kit, power tool adaptor, fleece bag, remote control	4933493595	4058546484668
AS 2-250 ELCP	25 l L-class dust extractor	38	AS 2-250 ELCP	-	3.5 m hose with floor cleaning kit, 2 x powertool connection adaptor, PET filter, 1 x disposable bag, 1 x fleece bag, 1 x crevice nozzle	4933447480	4002395006274
AS 2-250EM	25 l M-class dust extractor	38	AS 2-250EM	-	4 m hose, floor cleaning kit, power tool adaptor, fleece bag, remote control	4933493593	4058546484644
AS 30 LAC	30 l L-class dust extractor	38	AS 30 LAC	-	2 x tool adaptor, hand tube, 2 x extension tube, floor / crevice nozzle, fleece filter bag, disposal bag, hose 4 m x 36 mm	4933459411	4058546010720
AS 30 MAC	30 l M-class dust extractor	38	AS 30 MAC	-	2 x tool adaptor, hand tube, 2 x extension tube, floor / crevice nozzle, fleece filter bag, disposal bag, hose 4 m x 38 mm	4933459415	4058546010768
AS 42 MAC	42 l M-class dust extractor	38	AS 42 MAC	-	2 x tool adaptor, hand tube, 2 x extension tube, floor / crevice nozzle, fleece filter bag, disposal bag, hose 4 m x 38 mm, trolley handle	4933459418	4058546010799
M12 FVCL	M12 FUEL™ wet/ dry vacuum	39	M12 FVCL-0	No batteries supplied, No charger supplied, No kitbox or bag supplied	Flexible hose, crevice tool, utility nozzle,	4933478186	4058546341190
M12 HV	M12™ sub compact stick vac	39	M12 HV-0	No batteries supplied, No charger supplied, No kitbox or bag supplied	Utility nozzle, extension wand, crevice tool	4933448390	4002395262908
M18 CV	M18™ hand vac	39	M18 CV-0	No batteries supplied, No charger supplied, No kitbox or bag supplied	Flexible hose, crevice tool, two piece wand, floor cleaning nozzle	4933459204	4002395289998
M18 F2VC23LG2	M18 FUEL™ NEXUS dual battery 23l L-class vacuum	38	M18 F2VC23LG2-0	No batteries supplied, No charger supplied, No kitbox or bag supplied	Remote control, flexible hose, crevice tool, floor utility nozzle, 2 x extension wands, curved handle, tool adapter, fleece bag	4933500140	4058546573041
M18 FBPV2	M18 FUEL™ backpack vacuum	38	M18 FBPV2-0	No batteries supplied, No charger supplied, No kitbox or bag supplied	1 x floor tool, 1 x crevice tool, 1 x telescopic extension wand, 1 x flexible hose, 1 x dust extraction adaptor	4933500039	4058546572037
M18 FPOVCL	M18 FUEL™ PACKOUT™ wet/ dry vacuum	39	M18 FPOVCL-0	No batteries supplied, No charger supplied, No kitbox or bag supplied	Flexible hose, crevice tool, utility nozzle, powertool adapter	4933478187	4058546341206
M18 FVC23L	M18 FUEL™ NEXUS 23l L-class vacuum	38	M18 FVC23L-0	No batteries supplied, No charger supplied, No kitbox or bag supplied	Flexible hose, crevice tool, floor utility nozzle, 2 x extension wands, curved handle, tool adapter, fleece bag	4933500141	4058546573058
M18 ONEF2VC34M	M18 FUEL™ M class AC/DC dual battery dust extractor with VACLINK™	38	M18 ONEF2VC34M-0	No batteries supplied, No charger supplied, No kitbox or bag supplied	Remote control, 2 x HEPA filters, fleece bag, hose, 2 x power tool dust port adaptors	4933498142	4058546513023
M18 VC2	M18™ wet/ dry vacuum	39	M18 VC2-0	No batteries supplied, No charger supplied, No kitbox or bag supplied	Flexible hose, crevice tool, utility nozzle, powertool adapter	4933464029	4058546219741
Electrofusion processor							
MXF EFP	MX FUEL™ electrofusion processor	48	MXF EFP-0	No batteries supplied, No charger supplied, No kitbox or bag supplied	4.5 m electrofusion leads, bar code scanner, fusion tips set	4933499034	4058546529031
			MXF EFP-802	2 x MXF XC608 Battery packs, MXF C Charger, No kitbox or bag supplied	4.5 m electrofusion leads, bar code scanner, fusion tips set	4933493806	4058546509668
Expanders							
C12 PXP	M12™ sub compact UPONOR™ Q&E expansion tool	51	C12 PXP-I06202C	2 x M12 B2 Battery packs, C12 C Charger, Kitbox	Grease	4933441715	4002395002016
			C12 PXP-I10202C	2 x M12 B2 Battery packs, C12 C Charger, Kitbox	Grease	4933441730	4002395002047
			C12 PXP-N202C	2 x M12 B2 Battery packs, C12 C Charger, Kitbox	Grease	4933441740	4002395002061
HD18 PXP	M18™ UPONOR™ Q&E expansion tool	51	HD18 PXP-H06202C	2 x M18 B2 Battery packs, M12-18 C Charger, Kitbox	Grease	4933441771	4002395001835
			HD18 PXP-H10202C	2 x M18 B2 Battery packs, M12-18 C Charger, Kitbox	Grease	4933441774	4002395001842

INDEX

Model		Page	Name	Kit included	Standard equipment	Article Number	EAN Code
M12 FPXP	M12 FUEL™ sub compact UPONOR™ Q&E expansion tool	51	M12 FPXP-0C	No batteries supplied, No charger supplied, Kitbox	Grease	4933472018	4058546324148
			M12 FPXP-I06202C	2 x M12 B2 Battery packs, C12 C Charger, Kitbox	Grease	4933472021	4058546324179
			M12 FPXP-I10202C	2 x M12 B2 Battery packs, C12 C Charger, Kitbox	Grease	4933472020	4058546324162
M18 FPXP	M18 FUEL™ UPONOR™ Q&E expansion tool	51	M18 FPXP-0C	No batteries supplied, No charger supplied, Kitbox	Grease	4933479436	4058546372309
			M18 FPXP-H06502C	2 x M18 B5 Battery packs, M12-18 FC Charger, Kitbox	Grease	4933479438	4058546372323
			M18 FPXP-H10502C	2 x M18 B5 Battery packs, M12-18 FC Charger, Kitbox	Grease	4933479437	4058546372316
M18 ONEBLPXPL	M18™ ONE-KEY™ FORCE LOGIC™ UPONOR™ Q&E hydraulic pipe expanding tool	51	M18 ONEBLPX-PL-502C	2 x M18 B5 Battery packs, M12-18 C Charger, Kitbox	-	4933464299	4058546222444
Grass trimmers, brush cutters, edgers							
M18 BLLT	M18™ brushless grass trimmer	54	M18 BLLT-0	No batteries supplied, No charger supplied, No kitbox or bag supplied	1 x steel pin, 1 x T30 torx key, 1 x trimmer line	4933472218	4058546326142
M18 F2BCU	M18 FUEL™ dual battery brush cutter	55	M18 F2BCU-0	No batteries supplied, No charger supplied, No kitbox or bag supplied	Bump feed spool, 3-tooth blade, double shoulder harness, 2 x guards	4933480859	4058546411442
			M18 F2BCU-122	2 x M18 FB12 Battery packs, M18 DBSC Charger, No kitbox or bag supplied	Bump feed spool, 3-tooth blade, double shoulder harness, 2 x guards	4933480860	4058546411459
M18 FBCU	M18 FUEL™ brush cutter	54	M18 FBCU-0	No batteries supplied, No charger supplied, No kitbox or bag supplied	Bump feed spool, 4-tooth blade, double shoulder harness, 2 x guards	4933492297	4058546416645
			M18 FBCU-802	2 x M18 FB8 Battery packs, M12-18 FC Charger, No kitbox or bag supplied	Bump feed spool, 4-tooth blade, double shoulder harness, 2 x guards	4933499211	4058546563752
M18 FEDG	M18 FUEL™ edger	55	M18 FEDG-0	No batteries supplied, No charger supplied, No kitbox or bag supplied	-	4933493556	4058546484279
M18 FOPH-BCA	QUIK-LOK™ brush cutter attachment	54	M18 FOPH-BCA	-	Barrier bar, 4-tooth blade	4932479986	4058546377809
M18 FOPH-EA	QUIK-LOK™ edger attachment	55	M18 FOPH-EA	-	-	4932464958	4058546229030
M18 FOPH-LTA	QUIK-LOK™ grass trimmer attachment	54	M18 FOPH-LTA	-	Bump feed spool, guard	4932464955	4058546229009
M18 FOPH-RA	QUIK-LOK™ reciprocator attachment	55	M18 FOPH-RA	-	-	4932492669	4058546475406
Grease and caulk guns							
C18 PCG/310	M18™ caulk gun with 310 ml canister	23	C18 PCG/310C-0B	No batteries supplied, No charger supplied, Tool bag	310 ml canister cartridge holder	4933459637	4058546028091
			C18 PCG/310C-201B	1 x M18 B2 Battery pack, M12-18 C Charger, Tool bag	310 ml canister cartridge holder	4933441310	4002395001439
C18 PCG/400	M18™ caulk gun with 400 ml tube	23	C18 PCG/400T-201B	1 x M18 B2 Battery pack, M12-18 C Charger, Tool bag	400 ml transparent tube	4933441812	4002395002368
C18 PCG/600	M18™ caulk gun with 600 ml tube	22	C18 PCG/600A-0B	No batteries supplied, No charger supplied, No kitbox or bag supplied	600 ml alum. tube	4933459638	4058546028107
			C18 PCG/600A-201B	1 x M18 B2 Battery pack, M12-18 C Charger, Tool bag	600 ml alum. tube	4933441305	4002395001422
			C18 PCG/600T-201B	1 x M18 B2 Battery pack, M12-18 C Charger, Tool bag	600 ml transp. tube	4933441808	4002395002375
M12 GG	M12™ sub compact grease gun	22	M12 GG-0	No batteries supplied, No charger supplied, No kitbox or bag supplied	14.4 mm flex hose with spring guard, straight grease coupler, right angle grease coupler, strap	4933440435	4002395000951
			M12 GG-401B	1 x M12 B4 Battery pack, C12 C Charger, Tool bag	14.4 mm flex hose with spring guard, straight grease coupler, right angle grease coupler, strap	4933441675	4002395001903
M12 PCG/310	M12™ sub compact caulk gun with 310 ml cartridge holder	23	M12 PCG/310C-0	No batteries supplied, No charger supplied, No kitbox or bag supplied	310 ml cart. holder	4933441783	4002395002269
			M12 PCG/310C-201B	1 x M12 B2 Battery pack, C12 C Charger, Tool bag	310 ml cart. holder	4933441655	4002395001866
M12 PCG/400	M12™ sub compact caulk gun with 400 ml tube	23	M12 PCG/400A-0	No batteries supplied, No charger supplied, Tool bag	400 ml alum. tube	4933441780	4002395002276
			M12 PCG/400A-201B	1 x M12 B2 Battery pack, C12 C Charger, Tool bag	400 ml alum. tube	4933441665	4002395001880
M12 PCG/600	M12™ sub compact caulk gun with 600 ml tube	22	M12 PCG/600A-0	No batteries supplied, No charger supplied, No kitbox or bag supplied	600 ml alum. tube	4933441786	4002395002283
			M12 PCG/600A-201B	1 x M12 B2 Battery pack, C12 C Charger, Tool bag	600 ml alum. tube	4933441670	4002395001897
M18 GG	M18™ grease gun	22	M18 GG-0	No batteries supplied, No charger supplied, No kitbox or bag supplied	14.4 mm flex hose with spring guard, straight grease coupler, right angle grease coupler, strap	4933440493	4002395000357
			M18 GG-201C	1 x M18 B2 Battery pack, M12-18 C Charger, Kitbox	14.4 mm flex hose with spring guard, straight grease coupler, right angle grease coupler, strap	4933440490	4002395000340

Model		Page	Name	Kit included	Standard equipment	Article Number	EAN Code
Hammer and dust extractor sets							
M18 FHACDDE	M18 FUEL™ high performance 4-mode 16 mm SDS-Plus hammer with dedicated dust extractor	12	M18 FHACDDE-0C	No batteries supplied, No charger supplied, Kitbox	Side handle, depth gauge, grease, replacement brush rings	4933498586	4058546524555
M18 ONEFHPXDEL	M18 FUEL™ high performance SDS-plus hammer with dedicated dust extractor	12	M18 ONEFHPX-DEL-552C	2 x M18 HB5.5 Battery packs, M12-18 FC Charger, Kitbox	Side handle, depth gauge, grease, FIXTEC™ 13 mm full metal chuck, dedicated dust extractor M18 FPDEXL	4933478498	4058546346911
M18 ONEFHDEL	M18 FUEL™ 4-mode 26 mm SDS-Plus hammer with FIXTEC™ chuck, ONE-KEY™ and with dedicated dust extractor	12	M18 ONEFH-DEL-552C	2 x M18 HB5.5 Battery packs, M12-18 FC Charger, Kitbox	Side handle, depth gauge, grease, FIXTEC™ 13 mm full metal chuck, M18 FDDEXL dedicated dust extractor	4933478506	4058546346997
Hammers and breakers							
HAC0850	8 kg class SDS-Max drilling and breaking hammer	9	HAC0850	-	Side handle	4933498603	4058546524722
K 1000 S	10 kg class SDS-Max breaking hammer	8	K 1000 S	-	Side handle	4933464120	4058546220655
K 1528 H	16 kg class 28 mm Hex breaking hammer	8	K 1528 H	-	Side handle	4933464118	4058546220631
K 1530 H	16 kg class 30 mm Hex breaking hammer	8	K 1530 H	-	Side handle	4933464117	4058546220624
K 2628 H	25 kg class 28 mm Hex breaking hammer	8	K 2628 H	-	-	4933471685	4058546295844
K 500 S	5 kg class breaking hammer	9	K 500 S	-	Additional front spade handle, grease, pointed chisel	4933398220	4002395234059
K 540 S	5 kg class drilling and breaking hammer	9	K 540 S	-	Additional handle, grease	4933418100	4002395238422
K 545 S	5 kg class drilling and breaking hammer	9	K 545 S	-	Auxiliary straight handle, grease	4933398200	4002395234073
K 750 S	7 kg class drilling and breaking hammer	9	K 750 S	-	Additional straight handle, grease	4933398753	4002395235223
K 900	10 kg class breaking hammer	8 - 9	K 900 K	-	Additional front spade handle, auxiliary straight handle, dust shield, grease	4933375650	4002395231614
			K 900 S	-	Additional front spade handle, auxiliary straight handle, dust shield, grease	4933375720	4002395232048
K 950	10 kg class drilling and breaking hammer	8	K 950 S	-	Additional front spade handle, auxiliary straight handle, dust shield, grease	4933375710	4002395232031
M12 FHAC16	M12 FUEL™ compact 16 mm SDS-plus hammer	11	M12 FHAC16-0	No batteries supplied, No charger supplied, No kitbox or bag supplied	Side handle, depth gauge, grease	4933499183	4058546563479
			M12 FHAC16-0X	No batteries supplied, No charger supplied, HD Box	Side handle, depth gauge, grease	4933499184	4058546563486
			M12 FHAC16-502X	2 x M12 HB5 Battery packs, C12 C Charger, HD Box	Side handle, depth gauge, grease	4933499185	4058546563493
M18 BLH	M18™ brushless 4-mode 26 mm SDS-Plus hammer	11	M18 BLH-0	No batteries supplied, No charger supplied, No kitbox or bag supplied	Side handle, depth gauge	4933479426	4058546372200
			M18 BLH-502X	2 x M18 B5 Battery packs, M12-18 FC Charger, HD Box	Side handle, depth gauge, grease	4933478894	4058546361761
M18 BLHACD26	M18™ brushless 26 mm SDS-Plus D-handle hammer	11	M18 BLHACD26-0	No batteries supplied, No charger supplied, No kitbox or bag supplied	Side handle, depth gauge, grease	4933492483	4058546418502
			M18 BLHACD26-0X	No batteries supplied, No charger supplied, HD Box	Side handle, depth gauge, grease	4933492482	4058546418496
			M18 BLHACD26-402X	2 x M18 B4 Battery packs, M12-18 C Charger, HD Box	Side handle, depth gauge, grease	4933492480	4058546418472
M18 BLHX	M18™ brushless 4-mode 26 mm SDS-Plus hammer with FIXTEC™ chuck	11	M18 BLHX-0X	No batteries supplied, No charger supplied, HD Box	Side handle, depth gauge, grease, FIXTEC™ 13 mm full metal chuck	4933478891	4058546361730
			M18 BLHX-502X	2 x M18 B5 Battery packs, M12-18 FC Charger, HD Box	Side handle, depth gauge, grease, FIXTEC™ 13 mm full metal chuck	4933478892	4058546361747
M18 FH	M18 FUEL™ 4-mode 26 mm SDS-Plus hammer	10	M18 FH-0	No batteries supplied, No charger supplied, No kitbox or bag supplied	Side handle, depth gauge	4933478499	4058546346928
			M18 FH-0X	No batteries supplied, No charger supplied, HD Box	Side handle, depth gauge	4933478500	4058546346935
M18 FHAC16	M18 FUEL™ high performance 4-mode 16 mm SDS-Plus hammer	11	M18 FHAC16-0	No batteries supplied, No charger supplied, No kitbox or bag supplied	Side handle, depth gauge, grease	4933498582	4058546524517
			M18 FHAC16-0X	No batteries supplied, No charger supplied, HD Box	Side handle, depth gauge, grease	4933498583	4058546524524
			M18 FHAC16-302X	2 x M18 HB3 Battery packs, M12-18 FC Charger, HD Box	Side handle, depth gauge, grease	4933498584	4058546524531
M18 FHAC0540	M18 FUEL™ 40 mm SDS-Max drilling and breaking hammer with ONE-KEY™	9	M18 FHAC0540-0C	No batteries supplied, No charger supplied, Kitbox	Side handle, depth gauge, grease	4933493137	4058546480080
			M18 FHAC0540-122C	2 x M18 FB12 Battery packs, M12-18 FC Charger, Kitbox	Side handle, depth gauge, grease	4933493138	4058546480097
M18 FHAC0745	M18 FUEL™ 45 mm SDS-Max drilling and breaking hammer with ONE-KEY™	9	M18 FHAC0745-0C	No batteries supplied, No charger supplied, Kitbox	Side handle, depth gauge, grease	4933493445	4058546483166

INDEX

Model		Page	Name	Kit included	Standard equipment	Article Number	EAN Code
			M18 FHAC0745-122C	2 x M18 FB12 Battery packs, M12-18 FC Charger, Kitbox	Side handle, depth gauge, grease	4933493446	4058546483173
M18 FHAC0D32	M18 FUEL™ 32 mm SDS-Plus D-handle hammer with ONE-KEY™	11	M18 FHAC0D32-0	No batteries supplied, No charger supplied, No kitbox or bag supplied	Side handle, depth gauge, grease,	4933492141	4058546415082
			M18 FHAC0D32-0C	No batteries supplied, No charger supplied, Kitbox	Side handle, depth gauge, grease,	4933492140	4058546415075
M18 FHAF0H16	M18 FUEL™ 16 mm SDS-PLUS hammer with integrated dust extractor	11	M18 FHAF0H16-0	No batteries supplied, No charger supplied, No kitbox or bag supplied	Side handle, 2x dust shroud	4933493531	4058546484026
			M18 FHAF0H16-0X	No batteries supplied, No charger supplied, HD Box	Side handle, 2x dust shroud	4933493532	4058546484033
			M18 FHAF0H16-302X	2 x M18 HB3 Battery packs, M12-18 FC Charger, HD Box	Side handle, 2x dust shroud	4933493533	4058546484040
M18 FHX	M18 FUEL™ 4-mode 26 mm SDS-Plus hammer with FIXTEC™	10	M18 FHX-0	No batteries supplied, No charger supplied, No kitbox or bag supplied	Side handle, depth gauge, FIXTEC™ 13 mm full metal chuck	4933478887	4058546361693
			M18 FHX-0X	No batteries supplied, No charger supplied, HD Box	Side handle, depth gauge, grease, FIXTEC™ 13 mm full metal chuck	4933478888	4058546361709
			M18 FHX-552X	2 x M18 HB5.5 Battery packs, M12-18 FC Charger, HD Box	Side handle, depth gauge, grease, FIXTEC™ 13 mm full metal chuck	4933478889	4058546361716
M18 ONEFH	M18 FUEL™ 4-mode 26 mm SDS-Plus hammer with ONE-KEY™	10	M18 ONEFH-0	No batteries supplied, No charger supplied, No kitbox or bag supplied	Side handle, depth gauge	4933478895	4058546361778
			M18 ONEFH-0X	No batteries supplied, No charger supplied, HD Box	Side handle, depth gauge, grease	4933478886	4058546361686
M18 ONEFHP	M18 FUEL™ high performance 4-mode 32 mm SDS-Plus hammer with ONE-KEY™	10	M18 ONEFHP-0X	No batteries supplied, No charger supplied, HD Box	Side handle, depth gauge, grease	4933478884	4058546361662
M18 ONEFHPX	M18 FUEL™ high performance 4-mode 32 mm SDS-Plus hammer with ONE-KEY™ and FIXTEC™ chuck	10	M18 ONEFHPX-0	No batteries supplied, No charger supplied, No kitbox or bag supplied	Side handle, depth gauge, FIXTEC™ 13 mm full metal chuck	4933478885	4058546361679
			M18 ONEFHPX-0X	No batteries supplied, No charger supplied, HD Box	Side handle, depth gauge, grease, FIXTEC™ 13 mm full metal chuck	4933478895	4058546346881
			M18 ONEFHPX-552X	2 x M18 HB5.5 Battery packs, M12-18 FC Charger, HD Box	Side handle, depth gauge, grease, FIXTEC™ 13 mm full metal chuck	4933478496	4058546346898
M18 ONEFHX	M18 FUEL™ 4-mode 26 mm SDS-Plus hammer with FIXTEC™ chuck and ONE-KEY™	10	M18 ONEFHX-0	No batteries supplied, No charger supplied, No kitbox or bag supplied	Side handle, depth gauge, FIXTEC™ 13 mm full metal chuck	4933478502	4058546346959
			M18 ONEFHX-0X	No batteries supplied, No charger supplied, HD Box	Side handle, depth gauge, grease, FIXTEC™ 13 mm full metal chuck	4933478503	4058546346966
			M18 ONEFHX-552X	2 x M18 HB5.5 Battery packs, M12-18 FC Charger, HD Box	Side handle, depth gauge, grease, FIXTEC™ 13 mm full metal chuck	4933478504	4058546346973
MXF DH2528H	MX FUEL™ 25 kg class 28 mm Hex demolition hammer	9	MXF DH2528H-0	No batteries supplied, No charger supplied, No kitbox or bag supplied	28 mm Hex pointed chisel (4932459774), 28 mm Hex 35 mm flat chisel (4932459775)	4933478985	4058546362676
			MXF DH2528HK2-602	Battery packs, Charger, No kitbox or bag supplied	28 mm Hex pointed chisel (4932459774), 28 mm Hex 35 mm flat chisel (4932459775)	4933493526	4058546483975
			MXF DH2528H-802	2 x MXF XC608 Battery packs, MXF FC Charger, No kitbox or bag supplied	28 mm Hex pointed chisel (4932459774), 28 mm Hex 35 mm flat chisel (4932459775)	4933499993	4058546571573
PCE 3/K	3 kg SDS-plus chipping hammer	9	PCE 3/K	-	Additional handle	4933384300	4002395232215
PFH 26 T	26 mm SDS-plus 2-mode fixing hammer	11	PFH 26 T	-	Side handle with metal depth gauge	4933464581	4058546225261
PH 26 T	26 mm SDS-Plus 3-mode hammer	11	PH 26 TX	-	Side handle with metal depth gauge	4933464579	4058546225247
			PH 26 T	-	Side handle with metal depth gauge	4933464580	4058546225254
PH 28	28 mm SDS-plus 3-mode hammer	11	PH 28 X	-	FIXTEC™ adaptor with keyless chuck	4933396392	4002395234943
			PH 28	-	Side handle with depth gauge	4933396396	4002395234936
PH 30	30 mm SDS-plus 3-mode hammer	10	PH 30 POWER X	-	FIXTEC™ adaptor with keyless chuck, side handle with metal depth gauge	4933396420	4002395234967
PLH 28	28 mm SDS-plus 3-mode L-shaped hammer	10	PLH 28 XE	-	Side handle, FIXTEC™ 13mm full metal chuck, 4m cable, depth gauge, grease	4933446800	4002395005499
			PLH 28 E	-	Side handle, 4m cable, depth gauge, grease	4933446790	4002395005482
PLH 32	M18 FUEL™ high performance 4-mode 32 mm SDS-Plus hammer with ONE-KEY™ and FIXTEC™ chuck	10	PLH 32 XE	-	Front handle with metal depth gauge, adaptor with 13 mm keyless chuck, drill bit lubricant	4933400069	4002395233342
Heat guns							
M12 SI	M12™ sub compact soldering iron	40	M12 SI-0	No batteries supplied, No charger supplied, No kitbox or bag supplied	Pointed tip, chisel tip	4933459760	4058546029326
			M12 SI-201C	1 x M12 B2 Battery pack, C12 C Charger, Kitbox	Pointed tip, chisel tip	4933459761	4058546029333

Model		Page	Name	Kit included	Standard equipment	Article Number	EAN Code
M18 BHG	M18™ heat gun	40	M18 BHG-0	No batteries supplied, No charger supplied, No kitbox or bag supplied	2 x nozzles	4933459771	4058546029432
			M18 BHG-502C	2 x M18 B5 Battery packs, M12-18 C Charger, Kitbox	2 x nozzles	4933459772	4058546029449
Hedge trimmers							
M12 FHT20	M12 FUEL™ hedge trimmer 20 cm	57	M12 FHT20-0	No batteries supplied, No charger supplied, No kitbox or bag supplied	Bar cover	4933479675	4058546374693
			M12 FHT20-402	2 x M12 B4 Battery packs, C12 C Charger, No kitbox or bag supplied	Bar cover	4933479676	4058546374709
M18 FHET60G2	M18 FUEL™ hedge trimmer 60 cm	56	M18 FHET60G2-0	No batteries supplied, No charger supplied, No kitbox or bag supplied	Bar cover	4933498384	4058546522537
			M18 FHET60G2-802	2 x M18 FB8 Battery packs, M12-18 FC Charger, No kitbox or bag supplied	Bar cover	4933498385	4058546522544
M18 FHET75G2	M18 FUEL™ hedge trimmer 75 cm	56	M18 FHET75G2-0	No batteries supplied, No charger supplied, No kitbox or bag supplied	Bar cover	4933498387	4058546522568
			M18 FHET75G2-802	2 x M18 FB8 Battery packs, M12-18 FC Charger, No kitbox or bag supplied	Bar cover	4933498388	4058546522575
M18 FHETE22	M18 FUEL™ extended pole hedge trimmer 216 cm	56	M18 FHETE22-0	No batteries supplied, No charger supplied, No kitbox or bag supplied	Bar cover	4933498515	4058546523848
			M18 FHETE22-802	2 x M18 FB8 Battery packs, M12-18 FC Charger, No kitbox or bag supplied	Bar cover	4933498516	4058546523855
M18 FHETE27	M18 FUEL™ extended pole hedge trimmer 267 cm	56	M18 FHETE27-0	No batteries supplied, No charger supplied, No kitbox or bag supplied	Bar cover	4933492910	4058546477813
			M18 FHETE27-802	2 x M18 FB8 Battery packs, M12-18 FC, No kitbox or bag supplied	Bar cover	4933492911	4058546477820
M18 FHETSP	M18 FUEL™ short pole hedge trimmer	57	M18 FHETSP-0	No batteries supplied, No charger supplied, No kitbox or bag supplied	Bar cover	4933500311	4058546616137
M18 FOPH-HTA	QUIK-LOK™ hedge trimmer attachment	57	M18 FOPH-HTA	-	Blade guard	4932464959	4058546229047
M18 FOPH-SHTA	QUIK-LOK™ short hedge trimmer attachment	57	M18 FOPH-SHTA	-	-	4932492666	4058546475376
Hydraulic pumps							
M18 HMP700	M18™ hydraulic mini pump 700 bar	45	M18 HMP700-0	No batteries supplied, No charger supplied, No kitbox or bag supplied	Shoulder strap	4933493928	4058546510886
			M18 HMP700-501	1 x M18 B5 Battery pack, M12-18 FC Charger, No kitbox or bag supplied	Shoulder strap	4933493921	4058546510817
M18 HUP700	M18™ hydraulic utility pump	45	M18 HUP700-121	1 x M18 FB12 Battery pack, M12-18 FC Charger, No kitbox or bag supplied	Corded remote controller, 1.8 m controller extension cord, male to male coupler adaptor CEJN series 115	4933499335	4058546564995
Impact drivers							
M12 BLIDRC	M12™ compact brushless impact driver	18	M12 BLIDRC-0	No batteries supplied, No charger supplied, No kitbox or bag supplied	Belt clip	4933499689	4058546568535
			M12 BLIDRC-202C	2 x M12 B2 Battery packs, C12 C Charger, Hard case	Belt clip	4933499690	4058546568542
M12 BRAID	M12™ sub compact right angle impact driver	19	M12 BRAID-0	No batteries supplied, No charger supplied, No kitbox or bag supplied	-	4933451247	4002395167715
M12 FID2	M12 FUEL™ sub compact 1/4" impact driver	18	M12 FID2-0	No batteries supplied, No charger supplied, No kitbox or bag supplied	-	4933479876	4058546376703
			M12 FID2-202X	2 x M12 B2 Battery packs, C12 C Charger, HD Box	-	4933479877	4058546376710
M12 FQID	M12 FUEL™ SURGE™ 1/4" Hex hydraulic impact driver	19	M12 FQID-0	No batteries supplied, No charger supplied, No kitbox or bag supplied	-	4933464972	4058546229177
			M12 FQID-202X	2 x M12 B2 Battery packs, C12 C Charger, HD Box	-	4933464973	4058546229184
M18 BLIDR	M18™ brushless 1/4" Hex impact driver	18	M18 BLIDR-0X	No batteries supplied, No charger supplied, HD Box	Bit holder	4933492842	4058546477134
			M18 BLIDR-502X	2 x M18 B5 Battery packs, M12-18 FC Charger, HD Box	Bit holder	4933492843	4058546477141
M18 BRAID	M18™ right angle impact driver	18	M18 BRAID-0	No batteries supplied, No charger supplied, No kitbox or bag supplied	-	4933447891	4002395006663
M18 FID3	M18 FUEL™ 1/4" Hex impact driver	18	M18 FID3-0	No batteries supplied, No charger supplied, No kitbox or bag supplied	Belt clip and bit holder	4933498061	4058546512217
			M18 FID3-0X	No batteries supplied, No charger supplied, HD Box	Belt clip and bit holder	4933479864	4058546376581
			M18 FID3-502X	2 x M18 B5 Battery packs, M12-18 FC Charger, HD Box	Belt clip and bit holder	4933479865	4058546376598
M18 FIDRQ	M18 FUEL™ SURGE™ 1/4" Hex hydraulic impact driver	18	M18 FIDRQ-0	No batteries supplied, No charger supplied, No kitbox or bag supplied	Belt clip and bit holder	4933498911	4058546527808
			M18 FIDRQ-0X	No batteries supplied, No charger supplied, HD Box	Belt clip and bit holder	4933498910	4058546527792

INDEX

Model		Page	Name	Kit included	Standard equipment	Article Number	EAN Code
			M18 FDRQ-502X	2 x M18 B5 Battery packs, M12-18 FC Charger, HD Box	Belt clip and bit holder	4933498912	4058546527815
M18 ONEID3	M18 FUEL™ ONE-KEY™ 1/4" Hex impact driver	18	M18 ONEID3-0X	No batteries supplied, No charger supplied, HD Box	Belt clip and bit holder	4933492800	4058546476717
Impact wrenches							
M12 FCWIF12G3	M12 FUEL™ 1/2" compact impact wrench with friction ring	21	M12 FCWIF12G3-0	No batteries supplied, No charger supplied, No kitbox or bag supplied	Belt hook	4933493454	4058546483258
			M12 FCWIF12G3-502X	2 x M12 HB5 Battery packs, C12 C Charger, HD Box	Belt hook	4933493455	4058546483265
M12 FCWIF38G3	M12 FUEL™ 3/8" compact impact wrench with friction ring	20	M12 FCWIF38G3-0	No batteries supplied, No charger supplied, No kitbox or bag supplied	Belt hook	4933493451	4058546483227
			M12 FCWIF38G3-502X	2 x M12 HB5 Battery packs, C12 C Charger, HD Box	Belt hook	4933493452	4058546483234
M12 FCWIP12G3	M12 FUEL™ 1/2" compact impact wrench with pin detent	21	M12 FCWIP12G3-0	No batteries supplied, No charger supplied, No kitbox or bag supplied	Belt hook	4933493457	4058546483289
M12 FSCIWF14	M12 FUEL™ 1/4" sub-compact impact wrench with friction ring	20	M12 FSCIWF14-0	No batteries supplied, No charger supplied, No kitbox or bag supplied	Belt hook	4933498973	4058546528423
			M12 FSCIWF14-252X	2 x M12 HB2.5 Battery packs, C12 C Charger, HD Box	Belt hook	4933498974	4058546528430
M12 FSCIWF38	M12 FUEL™ 3/8" sub-compact impact wrench with friction ring	20	M12 FSCIWF38-0	No batteries supplied, No charger supplied, No kitbox or bag supplied	Belt hook	4933498969	4058546528386
			M12 FSCIWF38-252X	2 x M12 HB2.5 Battery packs, C12 C Charger, HD Box	Belt hook	4933498970	4058546528393
M12 FRAIWF12	M12 FUEL™ 1/2" right angle impact wrench with friction ring	20	M12 FRAIWF12-0	No batteries supplied, No charger supplied, No kitbox or bag supplied	-	4933471699	4058546295981
M18 BRAIW	M18™ 3/8" right angle impact wrench	20	M18 BRAIW-0	No batteries supplied, No charger supplied, No kitbox or bag supplied	Belt hook	4933447899	4002395006670
M18 FHIW2F12	M18 FUEL™ 1/2" high torque impact wrench with friction ring	20	M18 FHIW2F12-0X	No batteries supplied, No charger supplied, HD Box	-	4933492782	4058546476533
			M18 FHIW2F12-502X	2 x M18 B5 Battery packs, M12-18 FC Charger, HD Box	-	4933492783	4058546476540
M18 FHIW2P12	M18 FUEL™ 1/2" high torque impact wrench with pin detent	20	M18 FHIW2P12-0X	No batteries supplied, No charger supplied, HD Box	Tether ring	4933492785	4058546476564
			M18 FHIW2P12-502X	2 x M18 B5 Battery packs, M12-18 FC Charger, HD Box	Tether ring	4933492786	4058546476571
M18 FHIWF1R	M18 FUEL™ 1" railway impact wrench with friction ring	21	M18 FHIWF1R-0C	No batteries supplied, No charger supplied, Kitbox	-	4933493140	4058546480110
			M18 FHIWF1R-122C	2 x M18 FB12 Battery packs, M12-18 FC Charger, Kitbox	-	4933499201	4058546563653
M18 FIW2F12	M18 FUEL™ 1/2" compact impact wrench with friction ring	21	M18 FIW2F12-0X	No batteries supplied, No charger supplied, HD Box	Belt hook	4933478443	4058546346348
			M18 FIW2F12-502X	2 x M18 B5 Battery packs, M12-18 FC Charger, HD Box	Belt hook	4933478444	4058546346355
M18 FIW2F38	M18 FUEL™ 3/8" compact impact wrench with friction ring	21	M18 FIW2F38-0X	No batteries supplied, No charger supplied, HD Box	Belt hook	4933478650	4058546348434
M18 FIW2P12	M18 FUEL™ 1/2" compact impact wrench with pin detent	21	M18 FIW2P12-0X	No batteries supplied, No charger supplied, HD Box	Belt hook	4933478446	4058546346379
			M18 FIW2P12-502X	2 x M18 B5 Battery packs, M12-18 FC Charger, HD Box	Belt hook	4933478447	4058546346386
M18 FMTIW2F12	M18 FUEL™ 1/2" mid-torque impact wrench with friction ring	20	M18 FMTIW2F12-0X	No batteries supplied, No charger supplied, HD Box	Belt hook	4933478449	4058546346409
			M18 FMTIW2F12-502X	2 x M18 B5 Battery packs, M12-18 FC Charger, HD Box	Belt hook	4933478450	4058546346416
M18 FMTIW2F38	M18 FUEL™ 3/8" mid torque impact wrench with friction ring	21	M18 FMTIW2F38-0X	No batteries supplied, No charger supplied, HD Box	Belt hook	4933479153	4058546369477
M18 FMTIW2P12	M18 FUEL™ 1/2" mid-torque impact wrench with pin detent	20	M18 FMTIW2P12-0X	No batteries supplied, No charger supplied, HD Box	Belt hook	4933478452	4058546346430
			M18 FMTIW2P12-502X	2 x M18 B5 Battery packs, M12-18 FC Charger, HD Box	Belt hook	4933478453	4058546346447
M18 ONEFHIWF1	M18 FUEL™ ONE-KEY™ 1" high torque impact wrench with friction ring	21	M18 ONEFHIWF1-0X	No batteries supplied, No charger supplied, HD Box	Side handle, tether ring	4933459732	4058546029043
			M18 ONEFHIWF1-802X	2 x M18 FB8 Battery packs, M12-18 FC Charger, HD Box	Side handle, tether ring	4933499254	4058546564186
M18 ONEFHIWF12	M18 FUEL™ ONE-KEY™ 1/2" high torque impact wrench with friction ring	20	M18 ONEFHIWF12-0X	No batteries supplied, No charger supplied, HD Box	-	4933459726	4058546028985
			M18 ONEFHIWF12-502X	2 x M18 B5 Battery packs, M12-18 FC Charger, HD Box	-	4933459727	4058546028992
M18 ONEFHIWF12E	M18 FUEL™ ONE-KEY™ 1/2" high torque impact wrench with friction ring and extended anvil	21	M18 ONEFHIWF12E-0X	No batteries supplied, No charger supplied, HD Box	-	4933478405	4058546345969
M18 ONEFHIWF1D	M18 FUEL™ ONE-KEY™ 1" high torque D-handle impact wrench with friction ring and extended anvil	21	M18 ONEFHIWF1D-0C	No batteries supplied, No charger supplied, Kitbox	Side handle, tether ring	4933471755	4058546296544

Model		Page	Name	Kit included	Standard equipment	Article Number	EAN Code
			M18 ONEFHIWF1D-121C	1 x M18 FB12 Battery pack, M12-18 FC Charger, Kitbox	Side handle, tether ring	4933499251	4058546564155
M18 ONEFHIWF1DS	M18 FUEL™ ONE-KEY™ 1" high torque D-handle impact wrench with friction ring and short anvil	21	M18 ONEFHIWF1DS-0C	No batteries supplied, No charger supplied, Kitbox	Side handle, tether ring	4933472071	4058546324674
			M18 ONEFHIWF1DS-121C	1 x M18 FB12 Battery pack, M12-18 FC Charger, Kitbox	Side handle, tether ring	4933499253	4058546564179
M18 ONEFHIWF34	M18 FUEL™ ONE-KEY™ 3/4" high torque impact wrench with friction ring	21	M18 ONEFHIWF34-0X	No batteries supplied, No charger supplied, HD Box	Belt hook	4933459729	4058546029012
			M18 ONEFHIWF34-502X	2 x M18 B5 Battery packs, M12-18 FC Charger, HD Box	Belt hook	4933459730	4058546029029
M18 ONEFHIWH716	M18 FUEL™ 7/16" hex utility high torque impact wrench with ONE-KEY™	21	M18 ONEFHIWH716-0X	No batteries supplied, No charger supplied, HD Box	Tether ring	4933479152	4058546369460
M18 ONEFHIWP12	M18 FUEL™ ONE-KEY™ 1/2" high torque impact wrench with pin detent	20	M18 ONEFHIWP12-0X	No batteries supplied, No charger supplied, HD Box	Belt hook	4933459724	4058546028961
			M18 ONEFHIWP12-502X	2 x M18 B5 Battery packs, M12-18 FC Charger, HD Box	Belt hook	4933459725	4058546028978
M18 ONEIWF12	M18 FUEL™ ONE-KEY™ 1/2" impact wrench with friction ring	21	M18 ONEIWF12-0X	No batteries supplied, No charger supplied, HD Box	Belt hook	4933459198	4002395289936
			M18 ONEIWF12-502X	2 x M18 B5 Battery packs, M12-18 FC Charger, HD Box	Belt hook	4933451374	4002395160525
M12 FRAIWF38	M12 FUEL™ 3/8" right angle impact wrench with friction ring	20	M12 FRAIWF38-0	No batteries supplied, No charger supplied, No kitbox or bag supplied	-	4933471700	4058546295998
Inflators							
M12 BI	M12™ sub compact inflator	40	M12 BI-0	No batteries supplied, No charger supplied, No kitbox or bag supplied	1x ball inflation needle, 1x presta chuck, 1x inflator nozzle, 1x schrader chuck	4933464124	4058546220693
M18 BI	M18™ Inflator	40	M18 BI-0	No batteries supplied, No charger supplied, No kitbox or bag supplied	1x inflation needle, 1x presta chuck, 1x inflator nozzle, 1x schrader chuck	4933478706	4058546348991
M18 FAC	M18 FUEL™ air compressor	40	M18 FAC-0	No batteries supplied, No charger supplied, No kitbox or bag supplied	-	4933472166	4058546325626
Inspection cameras							
M12 POSIC	M12™ PACKOUT™ sewer inspection camera	53	M12 POSIC-0	No batteries supplied, No charger supplied, No kitbox or bag supplied	1x 63 mm skid, 1x 30 mm skid	4933498371	4058546522407
M12 SIC020	M12™ sewer inspection camera 20 m with ONE-KEY™	53	M12 SIC020-0	No batteries supplied, No charger supplied, No kitbox or bag supplied	1x 31 mm skid, 1x 27 mm skid, 1x shoulder strap	4933498231	4058546521004
M12 SIC026	M12™ sewer inspection camera 26 m with ONE-KEY™	53	M12 SIC026-0	No batteries supplied, No charger supplied, No kitbox or bag supplied	1x 48 mm skid, 1x 63 mm skid, 1x shoulder strap	4933498230	4058546520991
M18 SIC30 HDR	M18™ sewer inspection camera reel 30 m, 25 mm HDR camera head	52	M18 SIC30 HDR-0	No batteries supplied, No charger supplied, No kitbox or bag supplied	Supplied with 1x 75 mm skid, 1x 100 mm skid, 1x shoulder strap	4933493952	4058546511128
M18 SIC36 HDR	M18™ sewer inspection camera reel 36 m, 25 mm HDR camera head	52	M18 SIC36 HDR-0	No batteries supplied, No charger supplied, No kitbox or bag supplied	1x 100 mm skid, 1x 64 mm skid, 1x backpack strap	4933493953	4058546511135
M18 SIC60 HDR	M18™ sewer inspection camera reel 60 m, 34 mm camera head	52	M18 SIC60 HDR-0	No batteries supplied, No charger supplied, No kitbox or bag supplied	1x 115 mm skid, 1x 75 mm skid	4933493954	4058546511142
M18 SIC60SC HDR	M18™ sewer inspection camera reel 60 m, 25 mm camera head	53	M18 SIC60SC HDR-0	No batteries supplied, No charger supplied, No kitbox or bag supplied	Supplied with 1x 75 mm skid, 1x 100 mm skid	4933493955	4058546511159
Jigsaws							
FSPE 110 X	Heavy Duty body grip jigsaw	34	FSPE 110 X	-	4 m cable, 5 saw blades, anti-splintering device, dust cap, absorption adaptor, sliding shoe	4933500567	4058546618698
JSPE 135	Heavy Duty top handle jigsaw	34	JSPE 135 TX	-	4 m cable, 5 saw blades, anti-splintering device, sliding shoe, dust cup, absorption adaptor	4933500568	4058546618704
M12 FJS	M12 FUEL™ bodygrip jigsaw	34	M12 FJS-0	No batteries supplied, No charger supplied, No kitbox or bag supplied	1 x blade, dust extraction adapter, dust cover, splinter guard, soft shoe	4933500574	4058546618766
			M12 FJS-422X	1 x M12 B4, 1 x M12 B2 Battery packs, C12 C Charger, HD Box	1 x blade, dust extraction adapter, dust cover, splinter guard, soft shoe	4933500575	4058546618773
M18 BJS	M18™ top handle jigsaw	34	M18 BJS-0	No batteries supplied, No charger supplied, No kitbox or bag supplied	Non scratch shoe, jigsaw blade, dust guard, dust pipe	4933451391	4002395157990
			M18 BJS-0X	No batteries supplied, No charger supplied, HD Box	Non scratch shoe, jigsaw blade, dust guard, dust pipe	4933459573	4058546027452
			M18 BJS-402C	2 x M18 B4 Battery packs, M12-18 C Charger, Kitbox	Non scratch shoe, jigsaw blade, dust guard, dust pipe	4933451389	4002395157976
M18 FBJS	M18 FUEL™ body grip jigsaw	34	M18 FBJS-0	No batteries supplied, No charger supplied, No kitbox or bag supplied	1 x blade, dust extraction adapter, dust cover, splinter guard, soft shoe	4933500558	4058546618605
			M18 FBJS-0X	No batteries supplied, No charger supplied, HD Box	1 x blade, dust extraction adapter, dust cover, splinter guard, soft shoe	4933500555	4058546618575
			M18 FBJS-502X	2 x M18 B5 Battery packs, M12-18 FC Charger, HD Box	1 x blade, dust extraction adapter, dust cover, splinter guard, soft shoe	4933500556	4058546618582
M18 FJS	M18 FUEL™ top handle jigsaw	34	M18 FJS-0	No batteries supplied, No charger supplied, No kitbox or bag supplied	1 x blade, dust extraction adapter, dust cover, splinter guard, soft shoe	4933499153	4058546530228

INDEX

Model		Page	Name	Kit included	Standard equipment	Article Number	EAN Code
	M18 FJS-0X			No batteries supplied, No charger supplied, HD Box	1 x blade, dust extraction adapter, dust cover, splinter guard, soft shoe	4933464726	4058546226718
	M18 FJS-502X			2 x M18 B5 Battery packs, M12-18 FC Charger, HD Box	1 x blade, dust extraction adapter, dust cover, splinter guard, soft shoe	4933464727	4058546226725
Knockout punch							
M18 HKP	M18™ FORCE LOGIC™ hydraulic knockout punch	45	M18 HKP-201C	1 x M18 B2 Battery pack, M12-18 C Charger, Kitbox	11.1 mm (7/16") draw stud, 19 mm (3/4") draw stud, quick connector, ball pull, adaptor	4933451202	4002395138906
			M18 HKP-201CA	1 x M18 B2 Battery pack, M12-18 C Charger, Kitbox	11.1 mm (7/16") draw stud, 19 mm (3/4") draw stud, quick connector, ball pull, adaptor, punches and dies: M16, M20, M25, M32, M40	4933451204	4002395138920
Laser distance meters							
LDM 100	100 m Laser distance meter	43	LDM 100	2 x AAA Batteries, No kitbox or bag supplied	Nylon carry pouch	4933459278	4058546002442
LDM 30	30 m Laser distance meter	43	LDM 30	2 x AAA Batteries, Blister packaging	Belt clip	4933459276	4058546002428
LDM 45	45 m Laser distance meter	43	LDM 45	2 x AAA Batteries, No kitbox or bag supplied	Nylon carry pouch	4933459277	4058546002435
LDM 50	50 m Laser distance meter	43	LDM 50	2 x AAA Batteries, No kitbox or bag supplied	Belt clip	4933447700	4002395006540
Lasers							
CLL	Alkaline green cross line laser	43	CLL-C	4 x AA Batteries, Kitbox	Track clip	4933478753	4058546360351
L4 CLL	USB rechargeable green cross line laser	43	L4 CLL-301C	1 x L4 B3 Battery pack, USB cable and wall plug, Kitbox	Track clip	4933478098	4058546340315
L4 CLLP	USB rechargeable green cross line laser with plumb points	43	L4 CLLP-301C	1 x L4 B3 Battery pack, USB cable and wall plug, Kitbox	Track clip	4933478099	4058546340322
M12 3PL	M12™ green 360° 3 plane laser	43	M12 3PL-0C	No batteries supplied, No charger supplied, Kitbox	Track clip, HIVIST	4933478103	4058546340360
			M12 3PL-401C	1 x M12 B4 Battery pack, C12 C Charger, Kitbox	Track clip, HIVIST	4933478102	4058546340353
			M12 3PLKIT-401P	1 x M12 B4 Battery pack, C12 C Charger, PACKOUT™ box	HIVIST, LLD50, LM360, TRP120, track clip	4933478960	4058546362423
			M12 3PLSKIT-401P	1 x M12 B4 Battery pack, C12 C Charger, PACKOUT™ box	HIVIST, TRP120, track clip	4933499379	4058546565435
M12 A3PLO	M12™ green auto alignment 360° 3 plane laser	43	M12 A3PLO-0C	No batteries supplied, No charger supplied, Kitbox	HVIST, laser detector	4933499001	4058546528706
			M12 A3PLO-401C	1 x M12 B4 Battery pack, C12 C Charger, Kitbox	HVIST, laser detector	4933499002	4058546528713
M12 CLL4P	M12™ cross line laser with 4 points	42	M12 CLL4P-0C	No batteries supplied, No charger supplied, Kitbox	Track clip, HIVIST	4933479202	4058546369965
			M12 CLL4P-301C	1 x M12 B3 Battery pack, C12 C Charger, Kitbox	Track clip, HIVIST	4933479203	4058546369972
M12 CLLP	M12™ green cross line laser with plumb points	43	M12 CLLP-0C	No batteries supplied, No charger supplied, Kitbox	Track clip, HIVIST	4933478101	4058546340346
			M12 CLLP-301C	1 x M12 B3 Battery pack, C12 C Charger, Kitbox	Track clip, HIVIST	4933478100	4058546340339
M18 RLOH600	M18™ 600 m horizontal rotary laser with ONE-KEY™	42	M18 RLOH600-201C	1 x M18 B2 Battery pack, M12-18 C Charger, Kitbox	1x RD600, detector clamp	4933493191	4058546480622
M18 RLOHV1200	M18™ 1200 m horizontal vertical auto dual grade rotary laser with ONE-KEY™	42	M18 RLOHV1200-501C	1 x M18 B5 Battery pack, M12-18 C Charger, Kitbox	1x RD1200, detector clamp, 1x remote control	4933493204	4058546480752
M18 RLOHVG300	M18™ 300 m green horizontal vertical rotary laser with ONE-KEY™	42	M18 RLOHVG300-501C	1 x M18 B5 Battery pack, M12-18 C Charger, Kitbox	1x RD300G, detector clamp	4933493194	4058546480653
Lawn mowers							
M18 F2LM46	M18 FUEL™ dual battery self-propelled lawn mower 46 cm	55	M18 F2LM46-0	No batteries supplied, No charger supplied, No kitbox or bag supplied	Mulch plug, 60 litre bag, rear side discharge chute	4933492010	4058546413774
			M18 F2LM46-802	2 x M18 FB8 Battery packs, M18 DBSC Charger, No kitbox or bag supplied	Mulch plug, 60 litre bag, rear side discharge chute	4933499215	4058546563790
M18 F2LM53	M18 FUEL™ dual battery self-propelled lawn mower 53 cm	55	M18 F2LM53-0	No batteries supplied, No charger supplied, No kitbox or bag supplied	Mulch plug, 70 litre bag, rear side discharge chute	4933479584	4058546373788
			M18 F2LM53-122	2 x M18 FB12 Battery packs, M18 DBSC Charger, No kitbox or bag supplied	Mulch plug, 70 litre bag, rear side discharge chute	4933499213	4058546563776
Metal saws							
CHS 355	2300 W chopsaw	29	CHS 355	-	Spanner, allen key, 355 mm cutting disc	4933411760	4002395236220
M18 FMCS	M18 FUEL™ 57 mm metal circular saw	29	M18 FMCS-0	No batteries supplied, No charger supplied, No kitbox or bag supplied	150 mm metal cutting blade, allen key	4933459191	4002395289264

Model		Page	Name	Kit included	Standard equipment	Article Number	EAN Code
	M18 FMCS-0X			No batteries supplied, No charger supplied, HD Box	150 mm metal cutting blade, allen key	4933459192	4002395289271
	M18 FMCS-502X			2 x M18 B5 Battery packs, M12-18 FC Charger, HD Box	150 mm metal cutting blade, allen key	4933459193	4002395289288
M18 FMCS66	M18 FUEL™ 66 mm metal circular saw	29	M18 FMCS66-0C	No batteries supplied, No charger supplied, Kitbox	203 mm metal cutting blade, allen key	4933472110	4058546325060
MCS 66	Dry cut metal circular saw	29	MCS 66	-	Cermet tipped blade, 42 teeth	4933440615	4002395000432
Mitre saw legstands, table saw and pipe stand							
MPS	MILWAUKEE® pipe stand	31	MPS	-	-	4933472022	4058546324186
MSL 1000	Mitre saw stand extendable up to 2 m	31	MSL 1000	-	-	4933428970	4002395241729
MSL 2000	Mitre saw stand extendable up to 2.5 m	31	MSL 2000	-	Pair of brackets	4933459617	4058546027896
MSL 3000	Mitre saw stand extendable up to 3 m	31	MSL 3000	-	-	4933411565	4002395236213
MSUV 280	Mitre saw stand extendable up to 2.8 m	31	MSUV 280	-	Universal brackets	4933478992	4058546362744
TSS 1000	Table saw stand	31	TSS 1000	-	-	4933464227	4058546221720
Mitre saws and table saw							
M18 FMS190	M18 FUEL™ 190 mm mitre saw	30	M18 FMS190-0	No batteries supplied, No charger supplied, No kitbox or bag supplied	Blade, clamp, dust bag	4933459619	4058546027919
M18 FMS254	M18 FUEL™ 254 mm mitre saw	30	M18 FMS254-0	No batteries supplied, No charger supplied, No kitbox or bag supplied	Saw blade, blade key, side handles, clamp	4933451729	4002395279418
M18 FMS305	M18 FUEL™ ONE-KEY™ 305 mm mitre saw	30	M18 FMS305-0	No batteries supplied, No charger supplied, No kitbox or bag supplied	Blade, clamp, wrench, side handles and dust bag	4933471205	4058546288334
			M18 FMS305-121	1 x M18 FB12 Battery pack, M12-18 FC Charger, No kitbox or bag supplied	Blade, clamp, wrench, side handles and dust bag	4933499181	4058546563455
M18 FTS210	M18 FUEL™ ONE-KEY™ table saw	30	M18 FTS210-0	No batteries supplied, No charger supplied, No kitbox or bag supplied	Blade, blade spanner, push stick, side fence, mitre gauge, anti-kickback pawls, riving knife, dust extraction chute	4933464722	4058546226671
			M18 FTS210-121B	1 x M18 FB12 Battery pack, M12-18 FC Charger, No kitbox or bag supplied	Blade, blade spanner, push stick, side fence, mitre gauge, anti-kickback pawls, riving knife, dust extraction chute	4933499179	4058546563431
Multi-tools							
C12 MT	M12™ sub compact multi-tool	34	C12 MT-0	No batteries supplied, No charger supplied, No kitbox or bag supplied	Hex wrench, 1 x adapter, 1 x plunge cut blade for wood, 1 x sanding backing pad, 3 x grit 60, 3 x grit 80, 3 x grit 120, 3 x grit 240	4933427180	4002395239276
			C12 MT-202B	2 x M12 B2 Battery packs, C12 C Charger, Tool bag	Hex wrench, 1 x adapter, 1 x plunge cut blade for wood, 1 x sanding backing pad, 3 x grit 60, 3 x grit 80, 3 x grit 120, 3 x grit 240	4933441710	4002395002009
			C12 MT-402B	2 x M12 B4 Battery packs, C12 C Charger, Tool bag	Hex wrench, 1 x adapter, 1 x plunge cut blade for wood, 1 x sanding backing pad, 3 x grit 60, 3 x grit 80, 3 x grit 120, 3 x grit 240	4933441705	4002395001989
M12 FMT	M12 FUEL™ multi-tool	34	M12 FMT-0	No batteries supplied, No charger supplied, No kitbox or bag supplied	Hex wrench, 1 x adapter, 1 x plunge cut blade OSC 112, 1 x sanding backing pad, 3 x grit 60, 3 x grit 80, 3 x grit 120, 3 x grit 240, dust guard, depth stop	4933472238	4058546326340
			M12 FMT-422X	1 x M12 B4, 1 x M12 B2 Battery packs, C12 C Charger, HD Box	Hex wrench, 1 x adapter, 1 x plunge cut blade OSC 112, 1 x sanding backing pad, 3 x grit 60, 3 x grit 80, 3 x grit 120, 3 x grit 240, dust guard, depth stop	4933472239	4058546326357
M18 BMT	M18™ multi-tool	34	M18 BMT-0	No batteries supplied, No charger supplied, No kitbox or bag supplied	Blade, sanding pad, UL blade adapter, blade adapter, clamp shaft, 5 x sanding paper	4933446203	4002395004928
			M18 BMT-0X	No batteries supplied, No charger supplied, HD Box	Blade, sanding pad, UL blade adapter, blade adapter, clamp shaft, 5 x sanding paper, dust port assembly, depth gauge, blade guard	4933459572	4058546027445
			M18 BMT-421C	1 x M18 B4, 1 x M18 B2 Battery packs, M12-18 C Charger, Kitbox	Blade, sanding pad, UL blade adapter, blade adapter, clamp shaft, 5 x sanding paper, dust port assembly, depth gauge, blade guard	4933446210	4002395004911
M18 FMT	M18 FUEL™ multi-tool	34	M18 FMT-0	No batteries supplied, No charger supplied, No kitbox or bag supplied	1x universal fit OPEN-LOK oscillating multi-tool wood blade, 1x multi-tool sanding pad, 1x 60 grit sand paper, 1x 80 grit sand paper, 2x 120 grit sand paper, and 1x 240 grit sand paper	4933498065	4058546512255

INDEX

Model		Page	Name	Kit included	Standard equipment	Article Number	EAN Code
	M18 FMT-0X			No batteries supplied, No charger supplied, HD Box	1x universal fit OPEN-LOK oscillating multi-tool wood blade, 1x multi-tool sanding pad, 1x 60 grit sand paper, 1x 80 grit sand paper, 2x 120 grit sand paper, and 1x 240 grit sand paper	4933478491	4058546346843
	M18 FMT-502X			2 x M18 B5 Battery packs, M12-18 FC Charger, HD Box	1x universal fit OPEN-LOK oscillating multi-tool wood blade, 1x multi-tool sanding pad, 1x 60 grit sand paper, 1x 80 grit sand paper, 2x 120 grit sand paper, and 1x 240 grit sand paper	4933478492	4058546346850
Nailers and staplers							
C12 PN	M12™ sub compact palm nailer	37	C12 PN-0	No batteries supplied, No charger supplied, No kitbox or bag supplied	Belt hook	4933427182	4002395239238
M12 BCST	M12™ sub compact cable stapler	37	M12 BCST-0	No batteries supplied, No charger supplied, No kitbox or bag supplied	Belt hook	4933480488	4058546407735
M12 BST	M12™ sub compact stapler	37	M12 BST-0	No batteries supplied, No charger supplied, No kitbox or bag supplied	Belt hook	4933459634	4058546028060
			M12 BST-202X	2 x M12 B2 Battery packs, C12 C Charger, HD Box	Belt hook	4933459635	4058546028077
M12 FCN18GS	M12 FUEL™ 18 GA straight brad nailer	37	M12 FCN18GS-0X	No batteries supplied, No charger supplied, HD Box	Belt hook	4933493354	4058546482251
			M12 FCN18GS-202X	2 x M12 B2 Battery packs, C12 C Charger, HD Box	Belt hook	4933493355	4058546482268
M18 FDN	M18 FUEL™ duplex nailer	37	M18 FDN-0C	No batteries supplied, No charger supplied, Kitbox	Belt hook	4933493600	4058546484712
M18 FFN	M18 FUEL™ 34° framing nailer 2-mode	36	M18 FFN-0C	No batteries supplied, No charger supplied, Kitbox	Allan key	4933471406	4058546290344
			M18 FFN-502C	2 x M18 B5 Battery packs, M12-18 FC Charger, Kitbox	Allan key	4933471404	4058546290320
M18 FFN21	M18 FUEL™ 21° framing nailer 2-mode	36	M18 FFN21-0C	No batteries supplied, No charger supplied, Kitbox	Allan key	4933478993	4058546362751
M18 FFNS	M18 FUEL™ 34° framing nailer with single shot only	36	M18 FFNS-502C	2 x M18 B5 Battery packs, M12-18 FC Charger, Kitbox	Allan key	4933478302	4058546344795
M18 FFUS	M18 FUEL™ fencing utility stapler	37	M18 FFUS-0C	No batteries supplied, No charger supplied, Kitbox	Allan key	4933479834	4058546376284
			M18 FFUS-302C	2 x M18 HB3 Battery packs, M12-18 FC Charger, Kitbox	Allan key	4933479832	4058546376260
M18 FN15GA	M18 FUEL™ 15 GA angled nail finish nailer 2-mode	36	M18 FN15GA-0X	No batteries supplied, No charger supplied, HD Box	Belt hook	4933478091	4058546340247
M18 FN16GA	M18 FUEL™ 16 GA angled nail finish nailer 2-mode	36	M18 FN16GA-0	No batteries supplied, No charger supplied, No kitbox or bag supplied	Belt hook	4933499154	4058546530235
			M18 FN16GA-0X	No batteries supplied, No charger supplied, HD Box	Belt hook	4933478094	4058546340278
			M18 FN16GA-202X	2 x M18 B2 Battery packs, M12-18 FC Charger, HD Box	Belt hook	4933478092	4058546340254
M18 FN16GS	M18™ FUEL™ 16 GA straight finish nailer	36	M18 FN16GS-0X	No batteries supplied, No charger supplied, HD Box	Belt hook	4933493353	4058546482244
M18 FN18GS	M18 FUEL™ 18 GS finish nailer	36	M18 FN18GS-0	No batteries supplied, No charger supplied, No kitbox or bag supplied	Belt hook	4933499155	4058546530242
			M18 FN18GS-0X	No batteries supplied, No charger supplied, HD Box	Belt hook	4933471409	4058546290375
			M18 FN18GS-202X	2 x M18 B2 Battery packs, M12-18 FC Charger, Tool bag	Belt hook	4933471407	4058546290351
M18 FNCS18GS	M18 FUEL™ narrow crown stapler 2-mode	37	M18 FNCS18GS-0X	No batteries supplied, No charger supplied, HD Box	Belt hook	4933471942	4058546298418
			M18 FNCS18GS-202X	2 x M18 B2 Battery packs, M12-18 FC Charger, HD Box	Belt hook	4933471940	4058546298395
M18 FRCN45	M18 FUEL™ roofing coil nailer	37	M18 FRCN45-0X	No batteries supplied, No charger supplied, HD Box	Belt hook	4933498168	4058546520373
			M18 FRCN45-302X	2 x M18 HB3 Battery packs, M12-18 FC Charger, HD Box	Belt hook	4933498169	4058546520380
Nibblers and shears							
M12 FNB16	M12 FUEL™ 1.6 mm nibbler	30	M12 FNB16-0	No batteries supplied, No charger supplied, No kitbox or bag supplied	Die, punch, die holder, chip collection bag	4933479617	4058546374112
			M12 FNB16-0X	No batteries supplied, No charger supplied, HD Box	Die, punch, die holder, chip collection bag	4933479618	4058546374129
			M12 FNB16-402X	2 x M12 B4 Battery packs, C12 C Charger, HD Box	Die, punch, die holder, chip collection bag	4933479619	4058546374136
M18 BMS12	M18™ metal shear	30	M18 BMS12-0	No batteries supplied, No charger supplied, No kitbox or bag supplied	Belt clip	4933447925	4002395006731
M18 BMS20	M18™ metal shear	30	M18 BMS20-0	No batteries supplied, No charger supplied, No kitbox or bag supplied	Belt clip	4933447935	4002395006748
M18 FNB35	M18 FUEL™ 3.5 mm nibbler	30	M18 FNB35-0X	No batteries supplied, No charger supplied, HD Box	Die, punch, die holder, chip collection bag	4933498982	4058546528515

Model		Page	Name	Kit included	Standard equipment	Article Number	EAN Code
	M18 FNB35-502X			2 x M18 B5 Battery packs, M12-18 FC Charger, HD Box	Die, punch, die holder, chip collection bag	4933498983	4058546528522
NRG kits							
L4 PPS	REDLITHIUM™ USB portable power source and charger kit	77	L4 PPS-301	1 x L4 B3 Battery pack, USB rechargeable power source and charger + USB cable, No kitbox or bag supplied	-	4932493335	4058546482060
M12 NRG-201	M12™ NRG pack	77	M12 NRG-201	1 x M12 B2 Battery packs, C12 C Charger, No kitbox or bag supplied	-	4933451900	4002395281497
M12 NRG-202	M12™ NRG pack	77	M12 NRG-202	2 x M12 B2 Battery packs, C12 C Charger, No kitbox or bag supplied	-	4933459209	4002395287246
M12 NRG-302	M12™ NRG pack	77	M12 NRG-302	2 x M12 B3 Battery packs, C12 C Charger, No kitbox or bag supplied	-	4933451902	4002395282111
M12 NRG-303	M12™ NRG pack	76	M12 NRG-303	3 x M12 B3 Battery packs, C12 C Charger, No kitbox or bag supplied	-	4933459207	4002395287222
M12 NRG-402	M12™ NRG pack	76	M12 NRG-402	2 x M12 B4 Battery packs, C12 C Charger, No kitbox or bag supplied	-	4933459211	4002395287260
M12 NRG-602	M12™ NRG pack	76	M12 NRG-602	2 x M12 B6 Battery packs, C12 C Charger, No kitbox or bag supplied	-	4933451903	4002395282128
M12 NRG-603	M12™ NRG pack	76	M12 NRG-603	3 x M12 B6 Battery packs, C12 C Charger, No kitbox or bag supplied	-	4933459208	4002395287239
M18 FORGEN-RG-122	M18™ FORGE™ batteries and charger kit	76	M18 FORGENRG-122	2 x M18 FB12 Battery packs, M12-18 FC Charger, No kitbox or bag supplied	-	4933498610	4058546524791
M18 FORGEN-RG-122DBSC	M18™ FORGE™ batteries and charger kit	77	M18 FORGEN-RG-122DBSC	2 x M18 FB12 Battery packs, M18 DBSC Charger, No kitbox or bag supplied	-	4933498614	4058546524838
M18 FORGEN-RG-602DBSC	M18™ FORGE battery and charger kit	76	M18 FORGEN-RG-602DBSC	2 x M18 FB6 Battery packs, M18 DBSC Charger, No kitbox or bag supplied	-	4933498549	4058546524180
M18 FORGEN-RG-802	M18™ FORGE™ batteries and charger kit	77	M18 FORGENRG-802	2 x M18 FB8 Battery packs, M12-18 FC Charger, No kitbox or bag supplied	-	4933498612	4058546524814
M18 FORGEN-RG-802DBSC	M18™ FORGE™ batteries and charger kit	77	M18 FORGEN-RG-802DBSC	2 x M18 FB8 Battery packs, M18 DBSC Charger, No kitbox or bag supplied	-	4933498616	4058546524852
M18 HNRG-302	M18™ HIGH OUTPUT™ NRG pack	76	M18 HNRG-302	2 x M18 HB3, 1 x M12 B2 Battery packs, M12-18 FC Charger, No kitbox or bag supplied	-	4933471071	4058546286996
M18 HNRG-552	M18™ HIGH OUTPUT™ NRG pack	76	M18 HNRG-552	2 x M18 HB5.5, 1 x M12 B3 Battery packs, M12-18 FC Charger, No kitbox or bag supplied	-	4933464713	4058546226589
M18 NRG-202	M18™ NRG pack	77	M18 NRG-202	2 x M18 B2 Battery packs, M12-18 C Charger, No kitbox or bag supplied	-	4933459213	4002395287284
M18 NRG-402	M18™ NRG pack	77	M18 NRG-402	2 x M18 B4 Battery packs, M12-18 FC Charger, No kitbox or bag supplied	-	4933459215	4002395287901
M18 NRG-502	M18™ NRG pack	77	M18 NRG-502	2 x M18 B5, 1 x M12 B2 Battery packs, M12-18 FC Charger, No kitbox or bag supplied	-	4933459217	4002395287925
M18 NRGR-502	M18™ resistant NRG kit	77	M18 NRGR-502	2 x M18 B5-CR Battery packs, M12-18 FC Charger, No kitbox or bag supplied	-	4932479831	4058546376253
MXF FORGEN-RG-122	MX FUEL™ FORGE batteries and charger kit	77	MXF FORGENRG-122	2 x MXF HD812 Battery packs, MXF SC Charger, No kitbox or bag supplied	-	4933493549	4058546484200
MXF FORGEN-RG-802FC	MX FUEL™ FORGE™ batteries and charger kit	76	MXF FORGEN-RG-802FC	2 x MXF XC608 Battery packs, MXF FC Charger, No kitbox or bag supplied	-	4932500037	4058546572013
MXF NRG-406	MX FUEL™ batteries and charger kit	76	MXF NRG-406	2 x MXF XC406 Battery packs, MXF C Charger, No kitbox or bag supplied	-	4933479160	4058546369545
Other M18 FOPH2 attachments							
M18 FOPH-BBA	QUIK-LOK™ bristle brush attachment	59	M18 FOPH-BBA	-	-	4932479985	4058546377793
M18 FOPH-CA	QUIK-LOK™ cultivator attachment	59	M18 FOPH-CA	-	-	4932492667	4058546475383
M18 FOPH-EXA	QUIK-LOK™ extension attachment	59	M18 FOPH-EXA	-	-	4932464960	4058546229054
M18 FOPH-RBA	QUIK-LOK™ rubber broom attachment	59	M18 FOPH-RBA	-	-	4932479984	4058546377786
Percussion drills							
M12 BLPDRC	M12™ compact brushless percussion drill	15	M12 BLPDRC-0	No batteries supplied, No charger supplied, No kitbox or bag supplied	Belt clip	4933500421	4058546617233
			M12 BLPDRC-202C	2 x M12 B2 Battery packs, C12 C Charger, Kitbox	Belt clip	4933500422	4058546617240
			M12 BLPDRC-402C	2 x M12 B4 Battery packs, C12 C Charger, Kitbox	Belt clip	4933500424	4058546617264
M12 FPD2	M12 FUEL™ sub compact percussion drill	15	M12 FPD2-0	No batteries supplied, No charger supplied, No kitbox or bag supplied	Belt clip and bit holder	4933479867	4058546376611
			M12 FPD2-202X	2 x M12 B2 Battery packs, C12 C Charger, HD Box	Belt clip and bit holder	4933479868	4058546376628

INDEX

Model		Page	Name	Kit included	Standard equipment	Article Number	EAN Code
			M12 FPD2-402X	2 x M12 B4 Battery packs, C12 C Charger, HD Box	Belt clip and bit holder	4933479869	4058546376635
			M12 FPD2-602X	2 x M12 B6 Battery packs, C12 C Charger, HD Box	Belt clip and bit holder	4933479870	4058546376642
M12 FPDX	M12 FUEL™ sub compact percussion drill with removable chuck	15	M12 FPDX-0	No batteries supplied, No charger supplied, No kitbox or bag supplied	Removable chuck and belt clip	4933464135	4058546220808
			M12 FPDX-202X	2 x M12 B2 Battery packs, C12 C Charger, HD Box	Removable chuck and belt clip	4933464136	4058546220815
			M12 FPDXXIT-202X	2 x M12 B2 Battery packs, C12 C Charger, HD Box	Removable chuck, offset attachment, right angle attachment	4933464138	4058546220839
M18 BLPD2	M18™ brushless percussion drill	14	M18 BLPD2-0X	No batteries supplied, No charger supplied, HD Box	Belt clip, side handle	4933464516	4058546224615
			M18 BLPD2-402X	2 x M18 B4 Battery packs, M12-18 FC Charger, HD Box	Belt clip, side handle	4933464560	4058546225056
			M18 BLPD2-502X	2 x M18 B5 Battery packs, M12-18 FC Charger, HD Box	Belt clip, side handle	4933464517	4058546224622
M18 BLPDRC	M18™ compact brushless percussion drill	15	M18 BLPDRC-0	No batteries supplied, No charger supplied, No kitbox or bag supplied	Belt clip	4933492820	4058546476915
			M18 BLPDRC-0X	No batteries supplied, No charger supplied, HD Box	Belt clip	4933492821	4058546476922
			M18 BLPDRC-202C	2 x M18 B2 Battery packs, M12-18 C Charger, Kitbox	Belt clip	4933492822	4058546476939
			M18 BLPDRC-402C	2 x M18 B4 Battery packs, M12-18 C Charger, Kitbox	Belt clip	4933492824	4058546476953
			M18 BLPDRC-502C	2 x M18 B5 Battery packs, M12-18 C Charger, Kitbox	Belt clip	4933492826	4058546476977
M18 FPD3	M18 FUEL™ percussion drill	14	M18 FPD3-0	No batteries supplied, No charger supplied, No kitbox or bag supplied	Belt clip, side handle	4933498060	4058546512200
			M18 FPD3-0X	No batteries supplied, No charger supplied, HD Box	Belt clip, side handle	4933479859	4058546376536
			M18 FPD3-402C	2 x M18 B4 Battery packs, M12-18 C Charger, Kitbox	Belt clip, side handle	4933492473	4058546418403
			M18 FPD3-502X	2 x M18 B5 Battery packs, M12-18 FC Charger, HD Box	Belt clip, side handle	4933479860	4058546376543
M18 ONEPD3	M18 FUEL™ ONE-KEY™ percussion drill	14	M18 ONEPD3-0	No batteries supplied, No charger supplied, No kitbox or bag supplied	Belt clip, side handle	4933501116	4058546624187
			M18 ONEPD3-0X	No batteries supplied, No charger supplied, HD Box	Belt clip, side handle	4933492798	4058546476694
			M18 ONEPD3-502X	2 x M18 B5 Battery packs, M12-18 FC Charger, HD Box	Belt clip, side handle	4933492801	4058546476724
Pipe cutters							
C12 PC	M12™ sub compact copper pipe cutter	50	C12 PC-0	No batteries supplied, No charger supplied, No kitbox or bag supplied	1 cutting wheel	4933411920	4002395236374
C12 PPC	M12™ sub compact PEX cutter	50	C12 PPC-0	No batteries supplied, No charger supplied, No kitbox or bag supplied	-	4933416550	4002395237203
M12 PCSS	M12™ RAPTOR pipe cutter stainless steel	50	M12 PCSS-0	No batteries supplied, No charger supplied, No kitbox or bag supplied	1 x spare blade, 2 x retaining clip, 1 x oil tube	4933479241	4058546370350
			M12 PCSS-202C	2 x M12 B2 Battery packs, C12 C Charger, Kitbox	1 x spare blade, 2 x retaining clip, 1 x oil tube	4933479242	4058546370367
M12 PCSS54	M12™ RAPTORXL pipe cutter stainless steel	50	M12 PCSS54-0	No batteries supplied, No charger supplied, No kitbox or bag supplied	1 x spare blade, 1 x retaining clip, 1 x oil tube	4933498374	4058546522438
			M12 PCSS54-402C	2 x M12 B4 Battery packs, C12 C Charger, Kitbox	1 x spare blade, 1 x retaining clip, 1 x oil tube	4933498605	4058546524746
M18 FPCS	M18 FUEL™ steel pipe cutter	50	M18 FPCS-0	No batteries supplied, No charger supplied, No kitbox or bag supplied	1 x blade	4933498914	4058546527839
			M18 FPCS-502X	2 x M18 B5 Battery packs, M12-18 FC Charger, HD Box	1 x blade	4933498915	4058546527846
Pipe threaders							
M18 FPT114	M18 FUEL™ pipe threader 1 1/4" with ONE-KEY™	49	M18 FPT114-0C	No batteries supplied, No charger supplied, Kitbox	1 x support arm	4933480220	4058546405052
			M18 FPT114-802C	2 x M18 FB8 Battery packs, M12-18 FC Charger, Kitbox	1 x support arm	4933499198	4058546563622
			M18 FPT114-802CA	2 x M18 FB8 Battery packs, M12-18 FC Charger, Kitbox	1 x support arm, 4 x BSPT alloy heads (5/7 3/4 1 1/4)	4933499199	4058546563639
M18 FPT2	M18 FUEL™ pipe threader 2" with ONE-KEY™	49	M18 FPT2-0C	No batteries supplied, No charger supplied, Kitbox	1 x support arm	4933478596	4058546347895
			M18 FPT2-121C	1 x M18 FB12 Battery pack, M12-18 FC Charger, Kitbox	1 x support arm	4933499200	4058546563646
MXF PTR2	MX FUEL™ pipe threading machine 2"	49	MXF PTR2-0	No batteries supplied, No charger supplied, No kitbox or bag supplied	1/2" - 3/4" BSPT HS die set, 1" - 2" BSPT HS die set	4933498324	4058546521936
			MXF PTR2-601	1 x MXF XC406 Battery pack, MXF C Charger, No kitbox or bag supplied	1/2" - 3/4" BSPT HS die set, 1" - 2" BSPT HS die set	4933492100	4058546414672

Model		Page	Name	Kit included	Standard equipment	Article Number	EAN Code
Planer, routers, rotary tools							
C12 RT	M12™ sub compact rotary tool	35	C12 RT-0	No batteries supplied, No charger supplied, No kitbox or bag supplied	-	4933427183	4002395239030
M12 BLP	M12™ brushless planer	35	M12 BLP-0X	No batteries supplied, No charger supplied, HD Box	2 x spare blades, 1 x allen key, 1 x dust extraction adapter	4933492850	4058546477219
			M12 BLP-402X	2 x M12 B4 Battery packs, C12 C Charger, HD Box	2 x spare blades, 1 x allen key, 1 x dust extraction adapter	4933492851	4058546477226
M12 BLROT	M12™ brushless rotary tool	35	M12 BLROT-0	No batteries supplied, No charger supplied, No kitbox or bag supplied	3.2 mm collet	4933493591	4058546484620
M18 BP	M18™ planer	35	M18 BP-0	No batteries supplied, No charger supplied, No kitbox or bag supplied	Dust bag, edge & bevel guide	4933451113	4002395137374
			M18 BP-402C	2 x M18 B4 Battery packs, M12-18 C Charger, Kitbox	Dust bag, edge & bevel guide	4933451114	4002395137381
M18 FR12	M18 FUEL™ 12 mm router	35	M18 FR12-0X	No batteries supplied, No charger supplied, HD Box	1/4", 8 mm, 12 mm, 1/2" collets, side fence, sub base, wrench, dust extraction pipe	4933493304	4058546481759
			M18 FR12KIT-0P	No batteries supplied, No charger supplied, PACKOUT™ XL tool box	1/4", 8 mm, 12 mm, 1/2" collets, side fence, sub base, wrench, dust extraction pipe and plunge base	4933493305	4058546481766
M18 FTR8	M18 FUEL™ trim router with 8 mm/ 6 mm collets and bases	35	M18 FTR8-0X	No batteries supplied, No charger supplied, HD Box	2 x dust extraction attachments, 146 mm sub-base plate which accepts 31.75 mm guide bushings, 6 mm and 8 mm collets, plunge base, 2 x side fences	4933479073	4058546368678
Plumbing locator and inspection cameras							
AIC2	Alkaline inspection camera 2nd Gen	54	AIC2	4 x AA Batteries, Kitbox	4 x accessories	4933480738	4058546410230
M12 360IC12	M12™ 360° inspection camera 1.2 m 2nd Gen	54	M12 360IC12-0C	No batteries supplied, No charger supplied, Kitbox	4 x accessories	4933480739	4058546410247
			M12 360IC12-201C	1 x M12 B2 Battery pack, C12 C Charger, Kitbox	4 x accessories	4933480740	4058546410254
M12 360IC32	M12™ 360° Inspection Camera 3 m 2nd Gen	54	M12 360IC32-0C	No batteries supplied, No charger supplied, Kitbox	4 x accessories	4933480741	4058546410261
M12 PL	M12™ plumbing locator	54	M12 PL-0C	No batteries supplied, No charger supplied, Kitbox	1 x usb cable	4933471995	4058546298944
			M12 PL-201C	1 x M12 B2 Battery pack, C12 C Charger, Kitbox	1 x usb cable	4933478615	4058546348083
Plunge saw and circular saws							
CS 60	184 mm circular saw (61 mm DOC)	31	CS 60	-	Side fence, saw blade key	4933419225	4002395238361
CS 85 CBE	235 mm circular saw (85 mm DOC)	31	CS 85 CBE	-	side fence, saw blade, blade key	4933451116	4002395137404
CS 85 SB	235 mm circular saw (85 mm DOC)	31	CS 85 SB	-	Saw blade, fence, blade key	4933451117	4002395137411
HD18 CS	M18™ 55 mm circular saw for wood and plastic	33	HD18 CS-0	No batteries supplied, No charger supplied, No kitbox or bag supplied	24 tooth saw blade, parallel guide, dust port, allen key	4933419134	4002395238248
			HD18 CS-402B	2 x M18 B4 Battery packs, M12-18 C Charger, Tool bag	24 tooth saw blade, parallel guide, dust port, allen key, key, rip fence	4933441400	4002395001613
M12 FCS442	M12 FUEL™ sub compact circular saw	33	M12 FCS442-0	No batteries supplied, No charger supplied, No kitbox or bag supplied	Circular saw blade, side fence	4933493488	4058546483593
			M12 FCS442-502X	2 x M12 B5 Battery packs, C12 C Charger, HD Box	Circular saw blade, side fence	4933493489	4058546483609
M18 BLCS66	M18™ brushless 66 mm circular saw for wood and plastics	33	M18 BLCS66-0	No batteries supplied, No charger supplied, No kitbox or bag supplied	Saw blade, side fence, dust extraction chute, blade wrench	4933464588	4058546225339
			M18 BLCS66-0X	No batteries supplied, No charger supplied, HD Box	Saw blade, side fence, dust extraction chute, blade wrench	4933464589	4058546225346
			M18 BLCS66-502X	2 x M18 B5 Battery packs, M12-18 FC Charger, HD Box	Saw blade, side fence, dust extraction chute, blade wrench	4933464590	4058546225353
M18 FCS552	M18 FUEL™ compact circular saw	32	M18 FCS552-0	No batteries supplied, No charger supplied, No kitbox or bag supplied	Rip fence	4933493587	4058546484583
			M18 FCS552-0X	No batteries supplied, No charger supplied, HD Box	Rip fence	4933493588	4058546484590
			M18 FCS552-302X	2 x M18 HB3 Battery packs, M12-18 FC Charger, HD Box	Rip fence	4933493589	4058546484606
M18 FCS66GR3	M18 FUEL™ guide rail compatible circular saw	33	M18 FCS66GR3-0	No batteries supplied, No charger supplied, No kitbox or bag supplied	Rip fence, 190 x 30 x 1.8 mm 24 teeth blade (4932498976)	4933493491	4058546483623
			M18 FCS66GR3-121C	1 x M18 FB12 Battery pack, M12-18 FC Charger, Kitbox	Rip fence, 190 x 30 x 1.8 mm 24 teeth blade (4932498976)	4933493492	4058546483630
M18 FCSDC165	M18 FUEL™ 165 mm deep cut circular saw	32	M18 FCSDC165-0	No batteries supplied, No charger supplied, No kitbox or bag supplied	Side fence, blade CSB P W 165 x 20 x 1.6 x 24 ATB (4932471931)	4933500002	4058546571665
			M18 FCSDC165-0C	No batteries supplied, No charger supplied, Kitbox	Guide rail adapter, side fence, blade CSB P W 165 x 20 x 1.6 x 24 ATB (4932471931)	4933499996	4058546571603

INDEX

Model		Page	Name	Kit included	Standard equipment	Article Number	EAN Code
			M18 FCSDC165-552C	2 x M18 HB5.5 Battery packs, M12-18 FC Charger, Kitbox	Guide rail adapter, side fence, blade CSB P W 165 x 20 x 1.6 x 24 ATB (4932471931)	4933499997	4058546571610
M18 FCSO190GR	M18 FUEL™ 190 mm circular saw, guide rail and ONE-KEY™ compatible	33	M18 FCSO190GR-OC	No batteries supplied, No charger supplied, Kitbox	Rip fence, 190 x 30 x 1.8 mm 24 teeth blade (4932498976)	4933498993	4058546528621
			M18 FCSO-190GR-121C	1 x M18 FB12 Battery pack, M12-18 FC Charger, Kitbox	Rip fence, 190 x 30 x 1.8 mm 24 teeth blade (4932498976)	4933498994	4058546528638
M18 FCSRH662	M18 FUEL™ rear handle circular saw Gen2	32	M18 FCSRH662-0	No batteries supplied, No charger supplied, No kitbox or bag supplied	Rip fence, 190 x 30 x 1.8 mm 24 teeth blade 4932498976	4933498992	4058546528614
M18 FPS55	M18 FUEL™ 55 mm plunge saw	32	M18 FPS55-0P	No batteries supplied, No charger supplied, PACKOUT™ XL tool box	Dust bag, saw blade (4932471931), allen key	4933478777	4058546360597
			M18 FPS55-552P	2 x M18 HB5.5 Battery packs, M12-18 FC Charger, PACKOUT™ XL tool box	Dust bag, saw blade (4932471931), allen key	4933478778	4058546360603
SCS 65 Q	190 mm circular saw (65 mm DOC)	31	SCS 65 Q	-	4 m QUIK-LOK™ cable, carbide tipped 20 tooth saw blade, parallel guide, spanner	638051	4002395229529
Polishers							
AGS 15-125 C	1500 W grinder/sander	28	AGS 15-125 C	-	Quick release safety guard, side handle, flange, flange nut, spanner, 4 m cable, filter grill	4933407480	4002395236015
AP 12 E	1200 W polisher with electronic variable speed	28	AP 12 E	-	Side handle, 6 m cable, polishing backing pad	4933383925	4002395229406
AP 14-2 200 E	1450 W polisher	28	AP 14-2 200 E	-	Side handle, flexible backing pad	4933432800	4002395001156
			AP 14-2 200 E KIT	-	Side handle, flexible backing pad, soft & hard polishing sponge, lambswool pad, sanding & finishing compound, cloth	4933493427	4058546482985
AS 12 E	1200 W sander with electronic variable speed	28	AS 12 E	-	Hand guard, side handle, nut, spanner, 4 m cable, backing pad	4933383940	4002395229390
M12 BPS	M12™ sub compact polisher / sander	28	M12 BPS-0	No batteries supplied, No charger supplied, No kitbox or bag supplied	Polishing pad, sanding pad, polishing sponge white, polishing sponge yellow, lambswool, side handle	4933447791	4002395006557
			M12 BPS-421X	1 x M12 B4, 1 x M12 B2 Battery packs, C12 C Charger, HD Box	Polishing pad, sanding pad, polishing sponge white, polishing sponge yellow, lambswool, side handle	4933447799	4002395006564
M18 FAP	M18 FUEL™ polisher	28	M18 FAP180-0	No batteries supplied, No charger supplied, No kitbox or bag supplied	Polishing backing pad, dust screen, bale handle, AVS side handle	4933451549	4002395144518
			M18 FAP180-0X	No batteries supplied, No charger supplied, HD Box	Polishing backing pad, dust screen, bale handle, AVS side handle	4933451552	4002395144549
			M18 FAP180-502X	2 x M18 B5 Battery packs, M12-18 FC Charger, HD Box	Polishing backing pad, polishing sponge white, polishing sponge orange, lambswool, dust screen, bale handle, AVS side handle	4933451550	4002395144525
M18 FROP15	M18 FUEL™ random orbital polisher with 15 mm stroke	28	M18 FROP15-0	No batteries supplied, No charger supplied, No kitbox or bag supplied	125 mm backing pad, dust screen	4933499156	4058546530259
			M18 FROP15-0X	No batteries supplied, No charger supplied, HD Box	125 mm backing pad, dust screen	4933478834	4058546361167
			M18 FROP15-502X	2 x M18 B5 Battery packs, M12-18 FC Charger, HD Box	125 mm backing pad, dust screen	4933478835	4058546361174
			M18 FROP15-502X KIT	2 x M18 B5 Battery packs, M12-18 FC Charger, HD Box	125 mm backing pad, dust screen, 140 mm red sponge (hard), 140 mm yellow sponge (medium), red cloth, heavy compound, medium compound	4933492352	4058546417192
M18 FROP21	M18 FUEL™ random orbital polisher with 21 mm stroke	28	M18 FROP21-0X	No batteries supplied, No charger supplied, HD Box	150 mm backing pad, dust screen	4933478836	4058546361181
			M18 FROP21-502X	2 x M18 B5 Battery packs, M12-18 FC Charger, HD Box	150 mm backing pad, dust screen	4933478837	4058546361198
Portable lights							
FL-LED	Alkaline flood light	65	FL-LED	2 x AA Batteries, Blister packaging	-	4933464824	4058546227692
HL2-LED	Alkaline slim headlamp	67	HL2-LED	3 x AAA Batteries, Blister packaging	-	4933471286	4058546289140
HL-SF	Alkaline spot flood headlamp	67	HL-SF	3 x AAA Batteries, Blister packaging	-	4933471388	4058546290160
IPL-LED	Alkaline pen light	67	IPL-LED	2 x AAA Batteries, Blister packaging	-	4933459440	4058546011017
IR FFL	Internal rechargeable folding flood light	65	IR FFL	Integrated battery, USB cable, No kitbox or bag supplied	-	4933493528	4058546483999
IR FL	Internal USB rechargeable flashlight 500 lumens	67	IR FL500	Integrated battery, USB cable, Blister packaging	-	4933478586	4058546347796
IR HL	Internal USB rechargeable headlamp 450 lumens	67	IR HL450	Integrated battery, USB cable, Blister packaging	-	4933478587	4058546347802
IR PL	Internal USB rechargeable pen light 250 lumens	67	IR PL250	Integrated battery, USB cable, Blister packaging	-	4933478705	4058546348984

Model		Page	Name	Kit included	Standard equipment	Article Number	EAN Code
ISHL-LED	Alkaline intrinsically safe headlamp	67	ISHL-LED	3 x AAA Batteries, No kitbox or bag supplied	-	4933478112	4058546340452
L4 BOLTHL	BOLT™ headlamp 600 lumens USB rechargeable	66	L4 BOLTHL-301	1 x L4 B3 Battery pack, USB cable, Blister packaging	-	4933479902	4058546376963
L4 FFL	USB rechargeable folding flood light	64	L4 FFL-301	1 x L4 B3 Battery pack, USB cable, Blister packaging	-	4933479766	4058546375607
L4 FL	USB rechargeable pocket flood light	65	L4 FL-301	1 x L4 B3 Battery pack, USB cable, Blister packaging	-	4933479763	4058546375577
L4 FL2000	USB rechargeable flashlight 2000 lumens	66	L4 FL2000-301	1 x L4 B3 Battery pack, USB cable, Blister packaging	-	4933479637	4058546374310
L4 FMLED	USB rechargeable 800l fixed flashlight	66	L4 FMLED-301	1 x L4 B3 Battery pack, USB cable, Blister packaging	-	4933479770	4058546375645
L4 HL2	USB rechargeable headlamp 600 lumens	66	L4 HL2-301	1 x L4 B3 Battery pack, USB cable, Blister packaging	-	4933479963	4058546377571
L4 HLRP	USB rechargeable hard hat headlamp	66	L4 HLRP-301	1 x L4 B3 Battery pack, USB cable, Blister packaging	Hard hat clips	4933479767	4058546375614
L4 HL-VIS	USB rechargeable HI-VIS headlamp	66	L4 HL-VIS-301	1 x L4 B3 Battery pack, USB cable, Blister packaging	-	4933479768	4058546375621
L4 HSL	USB rechargeable hot stick light	65	L4 HSL-301	1 x L4 B3 Battery pack, USB cable, No kitbox or bag supplied	-	4933493968	4058546511289
L4 NL400	USB rechargeable neck light 400 lumens	67	L4 NL400-301	1 x L4 B3 Battery pack, USB cable, Blister packaging	-	4933479898	4058546376925
L4 PWL	USB rechargeable pivoting work light	65	L4 PWL-301	1 x L4 B3 Battery pack, USB cable, Blister packaging	-	4933479765	4058546375591
L4 SL	USB rechargeable stick light 550 lumens	64	L4 SL550-301	1 x L4 B3 Battery pack, USB cable, Blister packaging	-	4933478869	4058546361518
L4 TMLED	USB rechargeable 1100 lumens twist focus flashlight	66	L4 TMLED-301	1 x L4 B3 Battery pack, USB cable, Blister packaging	-	4933479769	4058546375638
M12 AL	M12™ LED area light	64	M12 AL-0	No batteries supplied, No charger supplied, Blister packaging	-	4933451394	4002395158621
M12 ALIP	M12™ multi-directional flood light with PACKOUT™ compatibility	65	M12 ALIP-0	No batteries supplied, No charger supplied, No kitbox or bag supplied	-	4933500321	4058546616236
M12 CML	M12™ colour matching light	64	M12 CML-401	1 x M12 B4 Battery pack, C12 C Charger, No kitbox or bag supplied	-	4933479366	4058546371609
M12 LL	M12™ LED lantern light	65	M12 LL-0	No batteries supplied, No charger supplied, Blister packaging	-	4932430562	4002395382231
M12 PAL	M12™ pivot area light	64	M12 PAL-0	No batteries supplied, No charger supplied, Blister packaging	-	4933478226	4058546344030
M12 POAL	M12™ PACKOUT™ area light 1400 lumens	65	M12 POAL-0	No batteries supplied, No charger supplied, No kitbox or bag supplied	-	4933480473	4058546407582
M12 SAL	M12™ stand light	63	M12 SAL-0	No batteries supplied, No charger supplied, No kitbox or bag supplied	-	4933464823	4058546227685
M12 SL	M12™ LED stick light	67	M12 SL-0	No batteries supplied, No charger supplied, Blister packaging	-	4932430178	4002395378395
M12 SLED	M12™ LED spot light	66	M12 SLED-0	No batteries supplied, No charger supplied, Blister packaging	-	4933451261	4002395170159
M12 TLED	M12™ LED torch	67	M12 TLED-0	No batteries supplied, No charger supplied, Blister packaging	-	4932430360	4002395380213
M12 UCL	M12™ undercarriage light	65	M12 UCL-0	No batteries supplied, No charger supplied, No kitbox or bag supplied	-	4933478868	4058546361501
M12 UHL	M12™ LED underhood light	65	M12 UHL-0	No batteries supplied, No charger supplied, No kitbox or bag supplied	Clamping attachment	4933459432	4058546010935
M18 ABL	M18™ area boom light	64	M18 ABL-0	No batteries supplied, No charger supplied, No kitbox or bag supplied	-	4933498147	4058546513078
M18 AL	M18™ LED area light	65	M18 AL-0	No batteries supplied, No charger supplied, Blister packaging	-	4932430392	4002395380534
M18 ALIS	M18™ service area light	65	M18 ALIS-0	No batteries supplied, No charger supplied, No kitbox or bag supplied	-	4933498148	4058546513085
M18 HOAL	M18™ high output area light	64	M18 HOAL-0	No batteries supplied, No charger supplied, No kitbox or bag supplied	-	4933478118	4058546340513
M18 HOSALC	M18™ high output stand area light charger	63	M18 HOSALC-0	No batteries supplied, No charger supplied, No kitbox or bag supplied	-	4933478116	4058546340490
M18 IL	M18™ LED inspection light	65	M18 IL-0	No batteries supplied, No charger supplied, Blister packaging	-	4932430564	4002395382255
M18 LL	M18™ LED lantern light	64	M18 LL-0	No batteries supplied, No charger supplied, Blister packaging	-	4932430563	4002395382248
M18 MDTL	M18™ multi-directional task light	64	M18 MDTL-0	No batteries supplied, No charger supplied, No kitbox or bag supplied	-	4933498149	4058546513092
M18 ONERSAL	M18™ ONE-KEY™ LED remote stand light	63	M18 ONERSAL-0	No batteries supplied, No charger supplied, No kitbox or bag supplied	-	4933459431	4058546010928
M18 ONESLDP	M18™ ONE-KEY™ LED compact site light charger	63	M18 ONESLDP-0	No batteries supplied, No charger supplied, No kitbox or bag supplied	-	4933459160	4002395287154
M18 ONESLSP	M18™ ONE-KEY™ LED compact site light	63	M18 ONESLSP-0	No batteries supplied, No charger supplied, No kitbox or bag supplied	Security cable	4933459155	4002395287109

INDEX

Model		Page	Name	Kit included	Standard equipment	Article Number	EAN Code
M18 PAL2	M18™ pivoting area light	64	M18 PAL2-0	No batteries supplied, No charger supplied, No kitbox or bag supplied	-	4933493547	4058546484187
M18 POALC	M18™ PACKOUT™ area light charger	64	M18 POALC-0	No batteries supplied, No charger supplied, No kitbox or bag supplied	-	4933478120	4058546340537
M18 SAL2	M18™ LED stand light	63	M18 SAL2-0	No batteries supplied, No charger supplied, No kitbox or bag supplied	-	4933492486	4058546418533
			M18 SAL2-502B	2 x M18 B5 Battery packs, M12-18 C Charger, Tool bag	-	4933492903	4058546477745
M18 SLED	M18™ LED search light	66	M18 SLED-0	No batteries supplied, No charger supplied, No kitbox or bag supplied	-	4933459159	4002395287147
M18 TAL	M18™ tradesman area light	65	M18 TAL-0	No batteries supplied, No charger supplied, No kitbox or bag supplied	-	4933464134	4058546220792
M18 TLED	M18™ LED torch	67	M18 TLED-0	No batteries supplied, No charger supplied, Blister packaging	-	4932430361	4002395380220
M18 URSL	M18™ utility remote spot light with ONE-KEY™	64	M18 URSL-0	No batteries supplied, No charger supplied, No kitbox or bag supplied	-	4933498303	4058546521721
ML-LED	Alkaline flashlight	67	ML-LED	3 x AAA Batteries, Blister packaging	-	4933464825	4058546227708
MXF TL	MX FUEL™ tower light	63	MXF TL-0	No batteries supplied, Integrated charger, No kitbox or bag supplied	-	4933492340	4058546417079
			MXF TL-601	1 x MXF XC406 Battery pack, Integrated charger, No kitbox or bag supplied	-	4933471844	4058546297435
MXF TLIC	MX FUEL™ compact site light	63	MXF TLIC-0	No batteries supplied, No charger supplied, No kitbox or bag supplied	-	4933498075	4058546512354
			MXF TLIC-601	1 x MXF XC406 Battery pack, MXF C Charger, No kitbox or bag supplied	-	4933498072	4058546512323
Power supplies							
IRPSUOP2500	ROLL-ON 7200/ 3600 W 2.5 kWh power supply	62	IRPSUOP2500	-	-	4933492133	4058546415006
IRPSUOP6000	Roll-on 7,200/ 3,600 W 6.0 kWh power supply	62	IRPSUOP6000	-	-	4933500156	4058546573201
MXF PS	MX FUEL™ power supply	62	MXF PS-0	No batteries supplied, Integrated charger, No kitbox or bag supplied	-	4933493922	4058546510824
			MXF PS-602	2 x MXF XC406 Battery packs, Integrated charger, No kitbox or bag supplied	-	4933479266	4058546370602
Precision fastening							
M12 ONEFTR12	M12 FUEL™ ONE-KEY™ 1/2" digital torque wrench	23	M12 ONEFTR12-0C	No batteries supplied, No charger supplied, Kitbox	-	4933464969	4058546229146
			M12 ONEFTR12-201C	1 x M12 B2 Battery pack, C12 C Charger, Kitbox	-	4933464970	4058546229153
M12 ONEFTR38	M12 FUEL™ ONE-KEY™ 3/8" digital torque wrench	23	M12 ONEFTR38-0C	No batteries supplied, No charger supplied, Kitbox	-	4933464966	4058546229115
			M12 ONEFTR38-201C	1 x M12 B2 Battery pack, C12 C Charger, Kitbox	-	4933464967	4058546229122
M18 ONEFIW2FC12	M18 FUEL™ ONE-KEY™ TORQUE-SENSE™ 1/2" controlled solar compact impact wrench with friction ring	23	M18 ONEFIW-2FC12-0X	No batteries supplied, No charger supplied, HD Box	Belt hook	4933493412	4058546482831
M18 ONEFMTIW-2FC12	M18 FUEL™ ONE-KEY™ TORQUE-SENSE™ 1/2" controlled solar mid-torque impact wrench with friction ring	23	M18 ONEFMTIW-2FC12-0X	No batteries supplied, No charger supplied, HD Box	Belt hook	4933493413	4058546482848
Press tools							
M12 ONEHPT	M12™ sub compact FORCE LOGIC™ hydraulic press tool with ONE-KEY™	48	M12 ONEHPT-0C	No batteries supplied, No charger supplied, Kitbox	-	4933481031	4058546413163
			M12 ONEHPT-202C	2 x M12 B2 Battery packs, C12 C Charger, Kitbox	-	4933481032	4058546413170
			M12 ONEHPT-202C Geberit Mapress Set	2 x M12 B2 Battery packs, C12 C Charger, Kitbox	3 x Geberit licensed Mapress jaws (15, 22, 28 mm)	4933481038	4058546413231
			M12 ONEHPT-202C M-Set	2 x M12 B2 Battery packs, C12 C Charger, Kitbox	3 x M-profile press jaws (15, 22, 28 mm)	4933481033	4058546413187
			M12 ONEHPT-202C TH-Set	2 x M12 B2 Battery packs, C12 C Charger, Kitbox	3 x TH-profile press jaws (16, 20, 26 mm)	4933481036	4058546413217
			M12 ONEHPT-202C U-Set	2 x M12 B2 Battery packs, C12 C Charger, Kitbox	3 x U-profile press jaws (16, 20, 25 mm)	4933481037	4058546413224
			M12 ONEHPT-202C V-Set	2 x M12 B2 Battery packs, C12 C Charger, Kitbox	3 x V-profile press jaws (15, 22, 28 mm)	4933481034	4058546413194
			M12 ONEHPT-202C V-Set 2	2 x M12 B2 Battery packs, C12 C Charger, Kitbox	3 x V-profile press jaws (14, 16, 22 mm)	4933481035	4058546413200
M18 BLHPT	M18™ FORCE LOGIC™ brushless presstool	48	M18 BLHPT-0C	No batteries supplied, No charger supplied, Kitbox	-	4933478248	4058546344252
			M18 BLHPT-202C	2 x M18 B2 Battery packs, M12-18 C Charger, Kitbox	-	4933451132	4002395138012

Model		Page	Name	Kit included	Standard equipment	Article Number	EAN Code
			M18 BLHPT-202C Geberit Mapress Set	2 x M18 B2 Battery packs, M12-18 C Charger, Kitbox	3 x Geberit Licensed Mapress jaws (15/22/28 mm)	4933480903	4058546411886
			M18 BLHPT-202C M-SET	2 x M18 B2 Battery packs, M12-18 C Charger, Kitbox	3 x M-profile jaws (15/22/28 mm)	4933451133	4002395138029
			M18 BLHPT-202C TH-SET	2 x M18 B2 Battery packs, M12-18 C Charger, Kitbox	3 x TH-profile jaws (16/20/32 mm)	4933451135	4002395138043
			M18 BLHPT-202C TH-SET2	2 x M18 B2 Battery packs, M12-18 C Charger, Kitbox	3 x TH-profile jaws (16/20/26 mm)	4933478071	4058546340049
			M18 BLHPT-202C U-SET	2 x M18 B2 Battery packs, M12-18 C Charger, Kitbox	3 x U-profile jaws (16/20/25 mm)	4933451136	4002395138050
			M18 BLHPT-202C V-SET	2 x M18 B2 Battery packs, M12-18 C Charger, Kitbox	3 x V-profile jaws (15/22/28 mm)	4933451134	4002395138036
M18 BLHPTXL	M18™ FORCE LOGIC™ brushless XL press tool	48	M18 BLHPTXL-0C	No batteries supplied, No charger supplied, PACKOUT™ box	-	4933479440	4058546372347
			M18 BLHPTXL-502C	2 x M18 B5 Battery packs, M12-18 C Charger, PACKOUT™ box	-	4933479441	4058546372354
M18 ONEBLHPT	M18™ FORCE LOGIC™ brushless press tool with ONE-KEY™	48	M18 ONEBLHPT-0C	No batteries supplied, No charger supplied, Kitbox	-	4933478305	4058546344825
			M18 ONEBLHPT-302C	2 x M18 HB3 Battery packs, M12-18 FC Charger, Kitbox	-	4933478306	4058546344832
			M18 ONEBLHPT-302C Geberit Mapress Set	2 x M18 HB3 Battery packs, M12-18 FC Charger, Kitbox	3 x Geberit licensed Mapress jaws (15/22/28 mm)	4933480904	4058546411893
			M18 ONEBLHPT-302C M-SET	2 x M18 HB3 Battery packs, M12-18 FC Charger, Kitbox	3 x M-profile jaws (15/22/28 mm)	4933478310	4058546345013
			M18 ONEBLHPT-302C TH-SET	2 x M18 HB3 Battery packs, M12-18 FC Charger, Kitbox	3 x TH-profile jaws (16/20/32 mm)	4933478307	4058546344986
			M18 ONEBLHPT-302C U-SET	2 x M18 HB3 Battery packs, M12-18 FC Charger, Kitbox	3 x U-profile jaws (16/20/25 mm)	4933478309	4058546345006
			M18 ONEBLHPT-302C V-SET	2 x M18 HB3 Battery packs, M12-18 FC Charger, Kitbox	3 x V-profile jaws (15/22/28 mm)	4933478308	4058546344993
Pruning shears							
M12 BLPRS	M12™ brushless pruning shears	58	M12 BLPRS-0	No batteries supplied, No charger supplied, No kitbox or bag supplied	Wrist strap, blade cover	4933480114	4058546403997
			M12 BLPRS-202	2 x M12 B2 Battery packs, C12 C Charger, No kitbox or bag supplied	Wrist strap, blade cover	4933480115	4058546404000
M18 BLTS	M18™ brushless telescopic shear	58	M18 BLTS-0	No batteries supplied, No charger supplied, No kitbox or bag supplied	Blade cover	4933480865	4058546411503
			M18 BLTS-551	1 x M18 HB5.5 Battery pack, M12-18 FC Charger, No kitbox or bag supplied	Blade cover	4933480866	4058546411510
Radios and speakers							
M12 RCDAB+	M12™ radio charger DAB+	35	M12 RCDAB+-0	No batteries supplied, No charger supplied, No kitbox or bag supplied	230V power adaptor	4933472114	4058546325107
M12 SPEJSG2	M12™ jobsite speaker	35	M12 SPEJSG2-0	No batteries supplied, No charger supplied, No kitbox or bag supplied	-	4933498433	4058546523022
M18 PRCDAB+	M18™ PACKOUT™ radio charger	35	M18 PRCDAB+-0	No batteries supplied, No charger supplied, No kitbox or bag supplied	-	4933472112	4058546325084
M18 RADDAB+G2	M18™ jobsite radio DAB+	35	M18 RADDAB+G2-0	No batteries supplied, No charger supplied, No kitbox or bag supplied	Power adaptor	4933492344	4058546417116
M18 RC	M18™ jobsite radio charger with Bluetooth®	35	M18 RC-0	No batteries supplied, No charger supplied, No kitbox or bag supplied	-	4933446639	4002395005420
M18 SPEJSG2	M18™ jobsite speaker	35	M18 SPEJSG2-0	No batteries supplied, No charger supplied, No kitbox or bag supplied	-	4933493530	4058546484019
Ratchets							
M12 FHIR14LR	M12 FUEL™ 1/4" extended reach high speed ratchet	22	M12 FHIR14LR-0	No batteries supplied, No charger supplied, No kitbox or bag supplied	-	4933480790	4058546410759
M12 FHIR38LR	M12 FUEL™ 3/8" extended reach high speed ratchet	22	M12 FHIR38LR-0	No batteries supplied, No charger supplied, No kitbox or bag supplied	-	4933480791	4058546410766
M12 FIR12G2	M12 FUEL™ 1/2" ratchet	22	M12 FIR12G2-0	No batteries supplied, No charger supplied, No kitbox or bag supplied	Button trigger, paddle trigger	4933498939	4058546528089
			M12 FIR12G2-252B	2 x M12 HB2.5 Battery pack, C12 C Charger, Tool bag	Button trigger, paddle trigger	4933498940	4058546528096
M12 FIR14G2	M12 FUEL™ 1/4" ratchet	22	M12 FIR14G2-0	No batteries supplied, No charger supplied, No kitbox or bag supplied	Button trigger, paddle trigger	4933498933	4058546528027
			M12 FIR14G2-252B	2 x M12 HB2.5 Battery pack, C12 C Charger, Tool bag	Button trigger, paddle trigger	4933498934	4058546528034
M12 FIR38G2	M12 FUEL™ 3/8" ratchet	22	M12 FIR38G2-0	No batteries supplied, No charger supplied, No kitbox or bag supplied	Button trigger, paddle trigger	4933498936	4058546528058
			M12 FIR38G2-252B	2 x M12 HB2.5 Battery pack, C12 C Charger, Tool bag	Button trigger, paddle trigger	4933498937	4058546528065
M12 FIR38LR	M12 FUEL™ 3/8" extended reach ratchet	22	M12 FIR38LR-0	No batteries supplied, No charger supplied, No kitbox or bag supplied	1/4" adaptor	4933471500	4058546293994

INDEX

Model		Page	Name	Kit included	Standard equipment	Article Number	EAN Code
M12 FPTR	M12 FUEL™ INSIDER™ pass-through ratchet	22	M12 FPTR-0	No batteries supplied, No charger supplied, No kitbox or bag supplied	8 mm - 15 mm pass-through socket, 16 mm - 19 mm socket, 21 mm socket, 1/4" anvil adapter, 3/8" anvil adapter, 1/4" Hex bit holder	4933499413	4058546565770
			M12 FPTR-202X	2 x M12 B2 Battery packs, C12 C Charger, HD Box	8 mm - 15 mm pass-through socket, 16 mm - 19 mm socket, 21 mm socket, 1/4" anvil adapter, 3/8" anvil adapter, 1/4" Hex bit holder	4933499411	4058546565756
M12 IR	M12™ sub compact ratchet	22	M12 IR-201B 3/8	1 x M12 B2 Battery pack, C12 C Charger, Tool bag	-	4933441720	4002395002023
			M12 IR-201B 1/4	1 x M12 B2 Battery pack, C12 C Charger, Tool bag	-	4933441725	4002395002030
Right angle drills							
C12 RAD	M12™ sub compact right angle drill	19	C12 RAD-0	No batteries supplied, No charger supplied, No kitbox or bag supplied	-	4933416900	4002395237678
			C12 RAD-202B	2 x M12 B2 Battery packs, C12 C Charger, Tool bag	-	4933441215	4002395001248
C18 RAD	M18™ compact right angle drill	19	C18 RAD-0	No batteries supplied, No charger supplied, No kitbox or bag supplied	-	4933427189	4002395239085
M18 CRAD2	M18 FUEL™ right angle drill	19	M18 CRAD2-0X	No batteries supplied, No charger supplied, HD Box	-	4933471641	4058546295400
M18 FRAD2	M18 FUEL™ SUPER HAWG™ 2-speed right angle drill driver gen II	19	M18 FRAD2-0	No batteries supplied, No charger supplied, No kitbox or bag supplied	Chuck key, side handle	4933471207	4058546288358
Rivet guns							
M12 BPRT	M12™ sub compact rivet tool	19	M12 BPRT-0	No batteries supplied, No charger supplied, No kitbox or bag supplied	Belt hook, allen key, 4 x nose pieces	4933464404	4058546223496
			M12 BPRT-201X	1 x M12 B2 Battery pack, C12 C Charger, HD Box	Belt hook, allen key, 4 x nose pieces	4933464405	4058546223502
M18 ONEFLT	M18 FUEL™ lockbolt tool with ONE-KEY™	19	M18 ONEFLT-0X	No batteries supplied, No charger supplied, HD Box	Belt hook	4933478637	4058546348304
			M18 ONEFLT-502X	2 x M18 B5 Battery packs, M12-18 FC Charger, HD Box	Belt hook	4933478638	4058546348311
M18 ONEFPRT	M18 FUEL™ rivet tool with ONE-KEY™	19	M18 ONEFPRT-0X	No batteries supplied, No charger supplied, HD Box	Belt hook, allen key, 4 x nose pieces	4933478601	4058546347949
			M18 ONEFPRT-202X	2 x M18 B2 Battery packs, M12-18 FC Charger, HD Box	Belt hook, allen key, 4 x nose pieces	4933478602	4058546347956
Roll groovers							
M18 FRGRO	M18 FUEL™ roll groover	49	M18 FRGRO114-0C	No batteries supplied, No charger supplied, Kitbox	-	4933479788	4058546375829
			M18 FRGRO114-802C	2 x M18 B5 Battery packs, M12-18 FC Charger, Kitbox	-	4933479789	4058546375836
M18 FRGRO2	M18 FUEL™ roll groover	49	M18 FRGRO2-0C	No batteries supplied, No charger supplied, Kitbox	-	4933499440	4058546566043
			M18 FRGRO2-122C	2 x M18 B5 Battery packs, M12-18 FC Charger, Kitbox	-	4933499441	4058546566050
Rotary drills and drivers							
DE 10 RX	630 W single high speed rotary drill	16	DE 10 RX	-	10 mm chuck	4933409211	4002395235353
DE 13 RP	630 W single speed rotary drill	16	DE 13 RP	-	Additional side handle with metal depth gauge	4933409194	4002395235346
PD2E 22 R	850 W 2-speed percussion drill	16	PD2E 22 R	-	Additional handle with metal depth gauge	4933419570	4002395238613
PD2E 24 R	1020 W 2-speed percussion drill	16	PD2E 24 R	-	Additional handle with metal depth gauge	4933419595	4002395238651
PD-705	705 W percussion drill	16	PD-705	-	Chuck, side handle, depth gauge, cable	4933431955	4002395243914
PDE 13 RX	630 W single speed percussion drill	16	PDE 13 RX	-	Additional side handle with metal depth gauge	4933409200	4002395235322
Rotary laser detectors							
LLD50	Laser line detector	42	LLD50	1 x AA Battery, No kitbox or bag supplied	Material clamp	4932478104	4058546340377
LRD100	Line/ rotary laser detector	42	LRD100	1 x AA Battery, No kitbox or bag supplied	Material clamp	4932479555	4058546373498
RD1200	Rotary laser detector 1200 m	42	RD1200	2 x AA Batteries, No kitbox or bag supplied	-	4932493207	4058546480783
RD300G	Rotary laser detector 300 m green	42	RD300G	2 x AA Batteries, No kitbox or bag supplied	-	4932493198	4058546480691
RD600	Rotary laser detector 600 m	42	RD600	2 x AA Batteries, No kitbox or bag supplied	-	4932493197	4058546480684

Model		Page	Name	Kit included	Standard equipment	Article Number	EAN Code
SAWZALL™, HACKZALL™							
C12 HZ	M12™ sub compact HACKZALL™	33	C12 HZ-0	No batteries supplied, No charger supplied, No kitbox or bag supplied	1 blade	4933500559	4058546618612
			C12 HZ-202C	2 x M12 B2 Battery packs, C12 C Charger, Kitbox	1 blade	4933500560	4058546618629
C18 HZ	M18™ HACKZALL™	33	C18 HZ-0	No batteries supplied, No charger supplied, No kitbox or bag supplied	1 blade	4933501112	4058546624149
			C18 HZ-0X	No batteries supplied, No charger supplied, HD Box	1 blade	4933459575	4058546027476
			C18 HZ-402B	2 x M18 B4 Battery packs, M12-18 C Charger, Tool bag	1 blade	4933501114	4058546624163
M12 CHZ	M12 FUEL™ sub compact hackzall™	33	M12 CHZ-0	No batteries supplied, No charger supplied, No kitbox or bag supplied	1 x SAWZALL™ blade	4933500572	4058546618742
			M12 CHZ-202X	2 x M12 B2 Battery packs, C12 C Charger, HD Box	1 x SAWZALL™ blade	4933500573	4058546618759
			M12 CHZ-402C	2 x M12 B4 Battery packs, C12 C Charger, Kitbox	1 x SAWZALL™ blade	4933500571	4058546618735
			M12 CHZ-602X	2 x M12 B6 Battery packs, C12 C Charger, HD Box	1 x SAWZALL™ blade	4933501117	4058546624194
M18 BSX	M18™ SAWZALL™	32	M18 BSX-0	No batteries supplied, No charger supplied, No kitbox or bag supplied	Saw blade	4933447275	4002395006113
			M18 BSX-402C	2 x M18 B4 Battery packs, M12-18 C Charger, Kitbox	Blade	4933447285	4002395006120
M18 FHZ	M18 FUEL™ HACKZALL™	33	M18 FHZ-0	No batteries supplied, No charger supplied, No kitbox or bag supplied	Saw blade	4933500566	4058546618681
			M18 FHZ-0X	No batteries supplied, No charger supplied, HD Box	Saw blade	4933500564	4058546618667
			M18 FHZ-502X	2 x M18 B5 Battery packs, M12-18 FC Charger, HD Box	Saw blade	4933500562	4058546618643
M18 FSX	M18 FUEL™ Super SAWZALL™	32	M18 FSX-0C	No batteries supplied, No charger supplied, Kitbox	Saw blade	4933464724	4058546226695
			M18 FSX-801C	1 x M18 B8 Battery pack, M12-18 FC Charger, Kitbox	Saw blade	4933499177	4058546563417
M18 FSZ	M18 FUEL™ SAWZALL™	32	M18 FSZ-0	No batteries supplied, No charger supplied, No kitbox or bag supplied	Saw blade	4933498063	4058546512231
			M18 FSZ-0X	No batteries supplied, No charger supplied, HD Box	Saw blade	4933478293	4058546344702
			M18 FSZ-502X	2 x M18 B5 Battery packs, M12-18 FC Charger, HD Box	Saw blade	4933478291	4058546344689
M18 ONEFSZ	M18 FUEL™ ONE-KEY™ SAWZALL™	32	M18 ONEFSZ-0	No batteries supplied, No charger supplied, No kitbox or bag supplied	Saw blade	4933499161	4058546530303
			M18 ONEFSZ-0X	No batteries supplied, No charger supplied, HD Box	Saw blade	4933478296	4058546344733
			M18 ONEFSZ-502X	2 x M18 B5 Battery packs, M12-18 FC Charger, HD Box	Saw blade	4933478294	4058546344719
SSD 1100 X	1100 W SAWZALL™	33	SSD 1100 X	-	4 m cable, 1 blade	4933416710	4002395237623
SSPE 1300 RX	1300 W SAWZALL™ with rotating handle	33	SSPE 1300 RX	-	4 m cable, 1 saw blade	4933440590	4002395001095
SSPE 1300 SX	1300 W SAWZALL™	33	SSPE 1300 SX	-	4 m cable, 1 SAWZALL™ blade, additional keyed blade clamp	4933428520	4002395241545
SSPE 1500 X	1500 W Super SAWZALL™	32	SSPE 1500 X	-	4 m cable, 1 SAWZALL™ blade, additional keyed blade clamp	4933428900	4002395241699
Screed, trowels							
MXF PSC	MX FUEL™ screed	5	MXF PSC-0	No batteries supplied, No charger supplied, No kitbox or bag supplied	MXF PSCA	4933479771	4058546375652
			MXF PSC-302	2 x MXF CP203 Battery packs, MXF C Charger, No kitbox or bag supplied	MXF PSCA	4933479772	4058546375669
MXF WBT60	MX FUEL™ 600 mm walk behind edging trowel	5	MXF WBT60-0	No batteries supplied, No charger supplied, No kitbox or bag supplied	1x set of combination blades (4pcs)	4933498325	4058546521943
			MXF WBT60-122	2 x MXF HD812 Battery packs, MXF SC Charger, No kitbox or bag supplied	1x set of combination blades (4pcs)	4933493601	4058546484729
MXF WBT90	MX FUEL™ 900 mm walk behind power trowel	5	MXF WBT90-0	No batteries supplied, No charger supplied, No kitbox or bag supplied	1x set of combination blades (4pcs)	4933498326	4058546521950
			MXF WBT90-122	2 x MXF HD812 Battery packs, MXF SC Charger, No kitbox or bag supplied	1x set of combination blades (4pcs)	4933493602	4058546484736
Screwdrivers							
M12 BD	M12™ sub compact driver	18	M12 BD-0	No batteries supplied, No charger supplied, No kitbox or bag supplied	-	4933441910	4002395002566
			M12 BD-202C	2 x M12 B2 Battery packs, C12 C Charger, Kitbox	-	4933441900	4002395002559

INDEX

Model		Page	Name	Kit included	Standard equipment	Article Number	EAN Code
M12 BSD	M12™ sub compact single speed driver	18	M12 BSD-0	No batteries supplied, No charger supplied, No kitbox or bag supplied	-	4933447135	4002395006021
M12 CD	M12 FUEL™ sub compact driver	18	M12 CD-0	No batteries supplied, No charger supplied, No kitbox or bag supplied	Belt clip	4933440450	4002395000968
M18 FSG	M18 FUEL™ screw gun	18	M18 FSG-0X	No batteries supplied, No charger supplied, HD Box	Belt clip	4933459201	4002395289967
M18 FSGC	M18 FUEL™ screw gun with a collated attachment	18	M18 FSGC-202X	2 x M18 B2 Battery packs, M12-18 FC Charger, HD Box	Belt clip	4933459199	4002395289943
Sectional sewer machines							
M12 HSFSM	M12™ high speed flexible shaft machine	52	M12 HSFSM-0	No batteries supplied, No charger supplied, No kitbox or bag supplied	1 X 10.5m with 6mm reception, 1 x standard chain 32-40mm, 1 x standard chain 50mm, 1 x 500 ml oil, 1 x set screw tool	4933498377	4058546522469
			M12 HSFSM-602	2 x M12 B6 Battery packs, C12 C Charger, No kitbox or bag supplied	1 X 10.5m with 6mm reception, 1 x standard chain 32-40mm, 1 x standard chain 50mm, 1 x 500 ml oil, 1 x set screw tool	4933498378	4058546522476
M18 FCSSM	M18 FUEL™ compact sectional sewer machine	52	M18 FCSSM-0	No batteries supplied, No charger supplied, No kitbox or bag supplied	1 x shoulder strap, 1 x 22 mm guide hose	4933478408	4058546345990
			M18 FCSSM-121	1 x M18 FB12 Battery pack, M12-18 FC Charger, No kitbox or bag supplied	1 x shoulder strap, 1 x 22 mm guide hose	4933499308	4058546564728
M18 HSFSM	M18™ high speed flexible shaft machine	52	M18 HSFSM-0	No batteries supplied, No charger supplied, No kitbox or bag supplied	1 x 23 m cable with 8 mm reception, 4 x standard chains in kitbox (32-40 mm/ 50 mm/ 75 mm/ 110 mm), 1 x 500 ml oil, 1x set screw tool	4933480721	4058546410063
			M18 HSFSM-122	2 x M18 FB12 Battery packs, M12-18 FC Charger, No kitbox or bag supplied	1 x 23 m cable with 8 mm reception, 4 x standard chains in kitbox (32-40 mm/ 50 mm/ 75 mm/ 110 mm), 1 x 500 ml oil, 1x set screw tool	4933499309	4058546564735
Sewer inspection monitors							
M12 SIM	M12™ sewer inspection monitor	53	M12 SIM-0	No batteries supplied, No charger supplied, No kitbox or bag supplied	-	4933493592	4058546484637
M18 SIM	M18™ sewer inspection monitor	53	M18 SIM-0	No batteries supplied, No charger supplied, No kitbox or bag supplied	-	4933471414	4058546290429
Sheet, detail, belt and random orbital sanders							
BS 100 LE	4" (100 mm) belt sander	36	BS 100 LE	-	4 m cable, dust bag, sanding belt 100 x 620 mm, grit 100	4933385150	4002395229222
M12 FBFL10	M12 FUEL™ band file 10 mm	36	M12 FBFL10-0	No batteries supplied, No charger supplied, No kitbox or bag supplied	2 x 60 grit belts	4933480958	4058546412432
			M12 FBFL10-402B	2 x M12 B4 Battery packs, C12 C Charger, Tool bag	2 x 60 grit belts	4933480959	4058546412449
M12 FBFL13	M12 FUEL™ band file 13 mm	37	M12 FBFL13-0	No batteries supplied, No charger supplied, No kitbox or bag supplied	2 x 60 grit belts	4933480960	4058546412456
			M12 FBFL13-402B	2 x M12 B4 Battery packs, C12 C Charger, Tool bag	2 x 60 grit belts	4933480961	4058546412463
M12 FDSS	M12 FUEL™ sub compact spot sander	36	M12 FDSS-0B	No batteries supplied, No charger supplied, Tool bag	Soft pad, pad saver, mesh paper	4933479680	4058546374747
			M12 FDSS-422X	1 x M12 B4, 1 x M12 B2 Battery packs, C12 C Charger, HD Box	Soft pad, pad saver, mesh paper	4933479681	4058546374754
M12 FROS2.5	M12 FUEL™ 150 mm random orbital sander with 2.5 mm orbit	37	M12 FROS2.5-0	No batteries supplied, No charger supplied, No kitbox or bag supplied	Backing pad - soft and hook & loop, backing pad - soft and PSA, universal vacuum adaptor, left-hand vacuum port, right-hand vacuum port	4933493647	4058546485184
			M12 FROS2.5-502X	2 x M12 HB5 Battery packs, C12 C Charger, HD Box	Backing pad - soft and hook & loop, backing pad - soft and PSA, universal vacuum adaptor, left-hand vacuum port, right-hand vacuum port	4933493648	4058546485191
M12 FROS5	M12 FUEL™ 150 mm random orbital sander with 5.0 mm orbit	37	M12 FROS5-0	No batteries supplied, No charger supplied, No kitbox or bag supplied	Backing pad - hard and hook & loop, backing pad - hard and PSA, universal vacuum adaptor, left-hand vacuum port, right-hand vacuum port	4933493650	4058546485214
			M12 FROS5-502X	2 x M12 HB5 Battery packs, C12 C Charger, HD Box	Backing pad - hard and hook & loop, backing pad - hard and PSA, universal vacuum adaptor, left-hand vacuum port, right-hand vacuum port	4933493651	4058546485221
M12 FSDR75	M12 FUEL™ 75 mm random orbit sander	37	M12 FSDR75-0B	No batteries supplied, No charger supplied, Tool bag	Hose adaptor, dust bag, holster, 9 x sanding pads	4933498232	4058546521011
			M12 FSDR75-202B	2 x M12 B2 Battery packs, C12 C Charger, Tool bag	Hose adaptor, dust bag, holster, 9 x sanding pads	4933498233	4058546521028
M18 BOS125	M18™ 125 mm random orbital sander	37	M18 BOS125-0	No batteries supplied, No charger supplied, No kitbox or bag supplied	Dust bag, vacuum adaptor, extension adaptor, two sanding sheets	4933464228	4058546221737
			M18 BOS125-502B	2 x M18 B5 Battery packs, M12-18 C Charger, Tool bag	Dust bag, vacuum adaptor, extension adaptor, two sanding sheets	4933464229	4058546221744
M18 BQSS	M18™ quarter sheet sander	36	M18 BQSS-0	No batteries supplied, No charger supplied, No kitbox or bag supplied	Dust bag, hole punch, spare smooth base, sanding sheets	4933479966	4058546377601

Model		Page	Name	Kit included	Standard equipment	Article Number	EAN Code
			M18 BQSS-502B	2 x M18 B5 Battery packs, M12-18 C Charger, Tool bag	Dust bag, hole punch, spare smooth base, sanding sheets	4933479967	4058546377618
M18 FBTS75	M18 FUEL™ 75 mm belt sander	36	M18 FBTS75-0	No batteries supplied, No charger supplied, No kitbox or bag supplied	Dust bag, 1 x sanding belt	4933479614	4058546374082
			M18 FBTS75-552X	2 x M18 HB5.5 Battery packs, M12-18 FC Charger, HD Box	Dust bag, 1 x sanding belt	4933479615	4058546374099
M18 FROS125	M18 FUEL™ 125 mm random orbit sander	37	M18 FROS125-0B	No batteries supplied, No charger supplied, Tool bag	Dust bag, sand paper	4933498253	4058546521226
			M18 FROS125-502X	2 x M18 B5 Battery packs, M12-18 FC Charger, HD Box	Dust bag, sand paper	4933498254	4058546521233
ROS 125 E	5" (125 mm) random orbit sander	37	ROS 125 E	-	Textile dust bag, sanding paper set (60, 80, 120 grit)	4933433180	4002395244010
Smart HUB for sewer machines							
M18 SISH	M18™ sewer inspection smart hub	53	M18 SISH-0	No batteries supplied, No charger supplied, No kitbox or bag supplied	1x USB-C cable	4933471415	4058546290436
M12 SICO BU	M12™ sewer inspection camera base unit	53	M12 SICO BU	No batteries supplied, No charger supplied, No kitbox or bag supplied	-	4933501257	4058546639730
Snow thrower							
M18 F2SSBL	M18 FUEL™ dual battery single stage snow blower	58	M18 F2SSBL-0	No batteries supplied, No charger supplied, No kitbox or bag supplied	-	4933500054	4058546572181
			M18 F2SSBL-122	2 x M18 FB12 Battery packs, M18 DFC Charger, No kitbox or bag supplied	-	4933500055	4058546572198
Specialised cutting tools							
M18 BLTRC	M18™ brushless threaded rod cutter	47	M18 BLTRC-0X	No batteries supplied, No charger supplied, HD Box	M6, M8, M10, M12 cutting dies	4933471150	4058546287788
			M18 BLTRC-522X	1 x M18 B5, 1 x M18 B2 Battery packs, M12-18 C Charger, HD Box	M6, M8, M10, M12 cutting dies	4933471151	4058546287795
M18 FRBC032	M18 FUEL™ rebar cutter	47	M18 FRBC032-0X	No batteries supplied, No charger supplied, HD Box	Cermet teeth blade, sparks collecting bag, hex key	4933499366	4058546565305
			M18 FRBC032-502X	2 x M18 B5 Battery packs, M12-18 FC Charger, HD Box	Cermet teeth blade, sparks collecting bag, hex key	4933499367	4058546565312
Sprayers							
M12 BHCS3L	M12™ handheld chemical sprayer 3.7 l	59	M12 BHCS3L-0	No batteries supplied, No charger supplied, No kitbox or bag supplied	Fan nozzle, angled adapter, shoulder strap, measuring cup, funnel	4933480781	4058546410667
			M12 BHCS3L-201	1 x M12 B2 Battery pack, C12 C Charger, No kitbox or bag supplied	Fan nozzle, angled adapter, shoulder strap, measuring cup, funnel	4933480782	4058546410674
M18 BBPFP2-CST	M18™ SWITCH TANK™ 15l chemical spray tank	59	M18 BBPFP2-CST	-	1 x straight cone and 1 x angled flat nozzle, stainless steel wand	4933498964	4058546528331
M18 BBPFP2-WST	M18™ SWITCH TANK™ 15l water supply	59	M18 BBPFP2-WST	-	1 x water nozzle	4933498965	4058546528348
Straight grinders							
DG 30 E	Variable speed single handed die grinder	28	DG 30 E	-	Spanner SW 17 / SW 15, 4 m cable, collet 6 mm	4933385100	4002395230013
DG 7 E	Low speed die grinder	28	DG 7 E	-	4 m cable, 6 mm collet, spanner SW 17 / SW 15	4933391200	4002395231928
DGL 30 E	Variable speed 2-handed die grinder	29	DGL 30 E	-	Spanner SW 17 / SW 15, 4 m cable, collet 6 mm	4933385120	4002395230037
DGL 34	Single high speed 2-handed die grinder	29	DGL 34	-	Spanner SW 17 / SW 15, 4 m cable, collet 6 mm	4933385110	4002395230020
M12 FDGA2	M12 FUEL™ angled die grinder with variable speed	28	M12 FDGA2-0	No batteries supplied, No charger supplied, No kitbox or bag supplied	6 & 8mm collet and spanner	4933498979	4058546528485
			M12 FDGA2-522B	1 x M12 HB5, 1 x M12 HB2.5 Battery packs, C12 C Charger, Tool bag	6 & 8mm collet and spanner	4933498980	4058546528492
			M12 FDGA2-522BA	1 x M12 HB5, 1 x M12 HB2.5 Battery packs, C12 C Charger, Tool bag	6 & 8mm collet, spanner, adaptor M16 x 1F - M14 M, M14 diamond drill 6 mm, M14 diamond drill 8 mm	4933500525	4058546618278
M12 FDGS	M12 FUEL™ straight die grinder	28	M12 FDGS-0	No batteries supplied, No charger supplied, No kitbox or bag supplied	6, 8 mm collet	4933471435	4058546290634
			M12 FDGS-422B	1 x M12 B4, 1 x M12 B2 Battery packs, C12 C Charger, Tool bag	6, 8 mm collet	4933471436	4058546290641
M18 FDGRB	M18 FUEL™ braking die grinder with slide switch	28	M18 FDGRB-0	No batteries supplied, No charger supplied, No kitbox or bag supplied	6 & 8mm collet, spanner, dust screen	4933480952	4058546412371
			M18 FDGRB-0X	No batteries supplied, No charger supplied, HD Box	6 & 8mm collet, spanner, dust screen	4933480953	4058546412388
			M18 FDGRB-502X	2 x M18 B5 Battery packs, M12-18 FC Charger, HD Box	6 & 8mm collet, spanner, dust screen	4933480954	4058546412395
M18 FDGROVB	M18 FUEL™ braking die grinder with ONE-KEY™, variable speed and slide switch	28	M18 FDGROVB-0X	No batteries supplied, No charger supplied, HD Box	6 & 8mm collet, spanner, dust screen	4933480955	4058546412401

INDEX

Model		Page	Name	Kit included	Standard equipment	Article Number	EAN Code
			M18 FDGROVB-502X	2 x M18 B5 Battery packs, M12-18 FC Charger, HD Box	6 & 8mm collet, spanner, dust screen	4933480956	4058546412418
M18 FDGROVPDB	M18 FUEL™ braking die grinder with ONE-KEY™, variable speed and paddle switch	28	M18 FDGROVPDB-0X	No batteries supplied, No charger supplied, HD Box	6 & 8mm collet, spanner, dust screen	4933480957	4058546412425
Strut shear							
M18 STSO	M18™ FORCE LOGIC™ strut shear	49	M18 STSO-0B	No batteries supplied, No charger supplied, Tool bag	41 x 41 mm cutting die set	4933492097	4058546414641
Test & measurement							
2205-40	Fork meter for electricians	46	2205-40	2 x AA Batteries, Tool bag	1 x test lead set	4933416972	4002395238026
2212-20	Auto voltage / continuity tester	46	2212-20	2 x AAA Batteries, No kitbox or bag supplied	Belt clip, test lead set	4933447776	4002395006526
2216-40	Light commercial multimeter	46	2216-40	2 x AA Batteries, No kitbox or bag supplied	1 x electrical test lead set	4933427309	4002395240128
2217-40	Digital multimeter	46	2217-40	2 x AA Batteries, Tool bag	1 x test lead set, 1 x thermocouple (dual banana)	4933416976	4002395238064
2235-40	Light commercial clamp meter	46	2235-40	2 x AA Batteries, No kitbox or bag supplied	1 x test lead set	4933427315	4002395240135
2267-40	10:1 Infrared Temp-Gun™	46	2267-40	1 x 9V Block Battery Batteries, No kitbox or bag supplied	-	4933451906	4002395282159
Tyre buffer, jump starter							
M12 FTB	M12 FUEL™ low speed tyre buffer	41	M12 FTB-0	No batteries supplied, No charger supplied, No kitbox or bag supplied	Adapter	4933472215	4058546326111
M18 JS2000	M18™ jump starter	41	M18 JS2000-0	No batteries supplied, No charger supplied, No kitbox or bag supplied	-	4933498026	4058546511869
Vacuum pump							
M18 FVP5	M18 FUEL™ vacuum pump 5 CFM	48	M18 FVP5-0	No batteries supplied, No charger supplied, No kitbox or bag supplied	500 ml oil bottle, 5/16" adaptor	4933492853	4058546477240
			M18 FVP5-801	1 x M18 FB8 Battery pack, M12-18 FC Charger, No kitbox or bag supplied	500 ml oil bottle, 5/16" adaptor	4933499248	4058546564124
Voltage detectors							
2225-20	Non contact voltage detector with laser thermometer	46	2225-20	2 x AAA Batteries, No kitbox or bag supplied	-	4932498859	4058546527280
NCVD	Non-contact voltage detector	46	NCVD	2 x AAA Batteries, No kitbox or bag supplied	-	4933500160	4058546573249
NCVDDF	Dual range non-contact voltage detector with flashlight	46	NCVDDF	2 x AAA Batteries, No kitbox or bag supplied	-	4933500162	4058546573263
NCVDF	Non-contact voltage detector with flashlight	46	NCVDF	Batteries,	-	4933500161	4058546573256
Water pumps							
M12 BSWP	M12™ HYDROPASS™ brushed stick water pump	8	M12 BSWP-0	No batteries supplied, No charger supplied, No kitbox or bag supplied	1x wrist lanyard	4933479639	4058546374334
			M12 BSWP-601	1 x M12 B6 Battery pack, C12 C Charger, No kitbox or bag supplied	1x wrist lanyard	4933479640	4058546374341
M18 BLSWP	M18™ HYDROPASS™ brushless stick water pump	8	M18 BLSWP-0	No batteries supplied, No charger supplied, No kitbox or bag supplied	Y-adapter for two 3/4" BSPT male, adapter for one 1 1/4" BSPT male	4933498559	4058546524289
			M18 BLSWP-801	1 x M18 FB8 Battery, M12-18 FC Charger, No kitbox or bag supplied	Y-adapter for two 3/4" BSPT male, adapter for one 1 1/4" BSPT male	4933498560	4058546524296
M18 BTP	M18™ compact transfer pump	8	M18 BTP-0	No batteries supplied, No charger supplied, No kitbox or bag supplied	-	4933471494	4058546293932
MXF SMP2	MX FUEL™ submersible pump	8	MXF SMP2-0	No batteries supplied, No charger supplied, No kitbox or bag supplied	Submersible pump incl. 10m power cord, power base unit, backpack harness, remote control	4933498162	4058546513221
			MXF SMP2-802	2 x MXF XC608 Battery packs, MXF FC Charger, No kitbox or bag supplied	Submersible pump incl. 10m power cord, power base unit, backpack harness, remote control	4933498163	4058546513238

System attachments	Page
Crimper dies	104 - 105
Strut shear dies	107
System attachments - angle grinders	100
Cutting and grinding dust extraction	100
Dust guard for cutting	100
Flexible backing pads	100
System attachments - bandsaws	101
Bandsaw covers	101
System attachments - cable cutters	106
System attachments - caulk guns	110
System attachments - circular saws	101
Guide rails and attachments	101
System attachments - die grinders	92
System attachments - drain cleaners	84
System attachments - dust absorption	113 - 115
Filter bags	114
Filter cartridges	114
M12™ / M18™ dust absorption system	113
System attachments - AIR TIP™ attachments	115
Vacuum cleaners	114
System attachments - electrical Test & Measuring	111
System attachments - expansion tools	109
Expander heads	109
RAPID SEAL™ expander heads	109
System attachments - flexible shaft machine	85
System attachments - hydraulic pump	108
System attachments - hydraulic knockout punch	108
System attachments - impact wrenches	96
System attachments - inspection cameras	112
System attachments - jigsaws	92
System attachments - lasers	116
System attachments - M18 FUEL™ fish tapes	107
System attachments - magnetic drill stands	82
System attachment - nailers	92
System attachments - nibblers	93
System attachments - ONE-KEY™ Bluetooth® tracking	111
System attachments - outdoor products	102 - 103
System attachments - chainsaws	102
System attachments - line trimmers	103
System attachments - mowers	103
System attachments - blowers	103
System attachments - other outdoor products	103
System attachments - pass-through ratchet	113
System attachments - pipe cutters	106

System attachments	Page
System attachments - pipe stand	112
System attachments - pipe threader	System attachments - pipe threader 80 - 81
System attachments - pipe threader die heads	81
System attachments - pipe threader dies	80
System attachments - planers	102
System attachments - plate shears	93
System attachments - portable battery extension	116
System attachments - press jaws	87 - 90
Empty PACKOUT™ foam insert	90
Pivoting ring jaws	90
Press jaw ACR streamline	90
Profile BPM	89
Profile FF	88
Profile G	88
Profile G 2	89
Profile M	87
Profile M 2	89
Profile TH	88
Profile U	87
Profile V	87
Profile Viega MEga Press	88
System attachments - rotary hammers	97 - 99
Keyed chucks	98
Keyless chucks	99
System attachments - routers	111
System attachments - sanders	91
Belt sanders	91
Random orbital sanders	91
System attachment - SAWZALL™	92
System attachments - screwdrivers	95 - 96
Side handles	95
QUIK-LOK™ cables	96
Universal right angle drill attachment	96
System attachments - sectional sewer machines	85
System attachments - threaded rod cutter	107
System attachments - vibrators	78 - 79
System attachments - concrete vibrator whips	78
System attachments - concrete vibrator heads	78
System attachments - high frequency concrete vibrator	78
System attachments - plate compactor	79
System attachments - screed	79
System attachments - trowel	79
System attachments - wall chasers	94
System attachments - wet diamond drilling	83



Nothing but **HEAVY DUTY.**[™]

Distributed by:

Techtronic Industries GmbH

Postfach 320
D-71361 Winnenden
Germany
Tel +497195120
Fax +49719512666