

Milwaukee®

Nothing but **HEAVY DUTY.**™



2026

ACCESSORIES, HAND TOOLS,
STORAGE AND PPE CATALOGUE



CONTENTS

ACCESSORIES

DRILLING & CHISELING

CHISELS

Hex 21mm/28mm/30mm	31 - 32
SDS-Max	30
SDS-Max Sledge Chisels	27 - 28
SDS-Plus	29
SDS-Plus Sledge Chisels	27 - 28

DIAMOND DRILLING

1 1/4" UNC / 1/2" G - Wet Diamond Drilling Core Drills	87 - 88
1 1/4" UNC / M16 - Dry Diamond Drilling Core Drills	89 - 90
M14 Dry Diamond Drills	83 - 85
Wet/Dry Diamond Holesaws	85 - 86

DRILLBITS: CONCRETE & MASONRY

Round Shank - Concrete/Masonry	35
SDS-Max - Other	23 - 26
SDS-Max 4 Cutter	20 - 21
SDS-Max Core Cutters/Tunnel Bits	22 - 23
SDS-Plus 2 Cutter (M2)	9 - 12
SDS-Plus 4 Cutter (MX4)	4 - 8
SDS-Plus Core Cutters	19
SDS-Plus Extensions	13 - 14
Dust Management	15 - 18

DRILLBITS: METAL

Countersinks	52
HSS Annular	66 - 67
HSS-G	57 - 58, 61
HSS-G Red Cobalt	50 - 51
HSS-G Ti Red Hex - SHOCKWAVE™ IMPACT DUTY	48 - 49
HSS-R	59 - 60
Step Drills	62 - 65
Thunderweb	53 - 57

DRILLBITS: OTHER

Glass & Tile	35
Multi Material	33 - 34

DRILLBITS: WOOD

Auger Bits	37 - 38
Auger Bits - SHOCKWAVE™ IMPACT DUTY	36
Cable Bits	44
Flat Bits	43
Forstner Bits	37, 39
Lip & Spur Bits	42
Selffeed Bits	41
SPEED FEED™ Bits	44
SWITCHBLADE™ Selffeed bits - SHOCKWAVE™ IMPACT DUTY	40

HOLESAWS

Adjustable Holesaw	78
BIG HAWG™ Multi Material	81
Contractor Bi-Metal	74
HCS PVC Holesaws	82
HOLE DOZER™ Bi-Metal	68 - 72, 79
HOLE DOZER™ Carbide	73, 79
Holesaw Accessories	75 - 77
Holesaws - SHOCKWAVE™ IMPACT DUTY	82
TCT Holesaws	80

FASTENING

Bit Holders - SHOCKWAVE™ IMPACT DUTY	96 - 97
Nails and Staples	116 - 121
Nut Drivers - SHOCKWAVE™ IMPACT DUTY	97 - 98
Screwdriving Attachments	99 - 100
Screwdriving Bits	100 - 101
Screwdriving Bits - SHOCKWAVE™ IMPACT DUTY	91 - 96
Sockets & Adaptors - SHOCKWAVE™ IMPACT DUTY	98, 102 - 115

SAWING, CUTTING & GRINDING

Cutting and Grinding	180
Coated Abrasives	187
Belts	194 - 196
Orbital/ Random Orbital/Delta Sheets	188 - 193
Wire Brushes	197 - 202
Polishing Accessories	203 - 205
System Attachments - Wet Diamond Drilling	206
System Attachments - Rotary Hammer	207
System Attachments - Planers	210
Chucks	208 - 209

DIAMOND TECHNOLOGY

Diamond Blades	170 - 178
Diamond Grinding Cup Wheels	179

GRINDING

Carbide Burrs	186
Fixtec Nuts	185
Flap Discs	183 - 184
Metal Cutting Grinding Discs	180 - 183

SAWING

Bandsaw Blades	168 - 169
Router Bits	148 - 163

CIRCULAR SAW BLADES

Hand held circular saws	164 - 165
Mitresaws	166
Table saws	166
Steel/metal cutting blades	167

JIGSAW BLADES

Metal	141 - 142
Special Applications	142 - 143
Wood & Plastics	138 - 140

MULTITOOL ACCESSORIES

Starlock Reception	144 - 148
--------------------	-----------

SAWZALL™ BLADES

DEMOLITION WOOD & NAILS

The AX™	130 - 131
Thin Kerf	131

METAL

The TORCH™ NITRUS / Carbide	124 - 126
The TORCH™	127 - 128
Thin Kerf	129

MULTI MATERIAL

The WRECKER™ Carbide	132
The Wrecker™	133
Sets	136
Special Applications	134 - 136
Wood & Plastics	133 - 134
HACKZALL™ Blades	137

HANDTOOLS

MEASURING, MARKING AND LEVELS

Tape Measures	211 - 218
Folding Rules	218
Long Tapes	219
Distance Meters	220
Levels	221 - 227
Digital Angle Gauge	221
Chalk Reels	228
Framing Square	229
Rafter Square	229
Inkzall Markers	230 - 232

CUTTING HAND TOOLS

Knives and Blades	233 - 238
Cutters (flush, plastic, tubing, bolt, cable)	237, 241 - 244
Saws	239 - 240
Scissors	240
Aviation Snips	241
Reaming Pen	242
Deburrer	243
Tap and Die	245 - 247

STRIKING AND DEMOLITION HAND TOOLS

Pullers	248 - 249
Wrecking Bars	249
Pry Bars	249, 254
Hammers	250 - 253
Chisels	253
Hook and Pick Sets	254

SCREWDRIVERS AND ELECTRICIAN HAND TOOLS

Wrenches	255 - 257
Hex Keys	258 - 259
ScrewDrivers	260 - 263
Nut Drivers	264 - 265
VDE ScrewDrivers	265 - 266
Wire and Cable Strippers	266 - 267
Fish Tape	267
Insulated Crimper	267

PLIERS

VDE Pliers	268 - 269
(Non VDE) Pliers	270
Pliers Wrenches	270

Fencing Pliers	272
Automotive Pliers	273 - 274
TORQUE LOCK™ Pliers	275
TORQUE LOCK™ clamps	276 - 277

SPANNERS AND WRENCHES

Wrenches	278 - 279
MAX BITE™ Combination Spanners	279 - 280
MAX BITE™ Ratcheting Combination Spanners	281
MAX BITE™ Flexible Head Ratcheting Combination Spanners	282
Double Open End Spanners	283
Double Ring Offset Spanners	284
Flare Nut Spanners	285
Pipe Wrenches	286 - 287
Adjustable Wrenches	287

RATCHETS AND SOCKETS

Ratchets and Sockets Sets	288 - 289
1/4" Drive Ratchets	290 - 292
1/4" Drive FOUR FLAT™ Sockets	293
1/4" Drive Hex Sockets	293
1/4" Drive Etorx Sockets	294
1/4" Drive Torx Sockets	294
1/4" Drive Adapters and Extensions	294 - 296
3/8" Drive Ratchets	296
3/8" Drive FOUR FLAT™ Sockets	297
3/8" Drive Spark Plug Sockets	298
3/8" Drive 12-Point Sockets	299
3/8" Drive Etorx Sockets	300
3/8" Drive Torx Sockets	300
3/8" Drive Hex Sockets	301
3/8" Drive Adapters and Extensions	301 - 302
1/2" Drive Ratchets	303
1/2" Drive FOUR FLAT™ Sockets	304
1/2" Drive Hex Sockets	305
1/2" Drive Torx Sockets	305
1/2" Drive 12-Point Sockets	306
1/2" Drive Etorx Sockets	307
1/2" Drive Adapters and Extensions	303, 308
T-bar Handles	309

OUTDOOR HAND TOOLS

TRADE SETS	310 - 313
	314 - 315

PERSONAL PROTECTIVE EQUIPMENT

BOLT™ Head Protection	326 - 333
Safety Glasses	333 - 336
Hearing Protection	337 - 338
High-Visibility Vests	339
Gloves	340 - 355
Lanyards	356 - 359
Heated Gear	360 - 364
Workwear	365 - 375
Knee Pads	376
Footwear	377-391

STORAGE

PACKOUT™

PACKOUT™ SETS	392 - 395
PACKOUT™ Rolling Storage	395 - 397
PACKOUT™ Boxes + Drawers	398 - 399, 402
PACKOUT™ Organisers	400 - 402
PACKOUT™ Coolers	403, 407
PACKOUT™ Soft Storage	404 - 407
PACKOUT™ Mounting Plates	408
PACKOUT™ Side attachments	409
Trays and dividers	410
PACKOUT™ Foam inserts	411 - 417
PACKOUT™ Drinkware	417 - 418
PACKOUT™ Shop storage	419 - 421
Aprons	422
Utility Buckets	423
Bags and totes	424 - 425
Workbelts and rigs	426 - 427
STEEL STORAGE	428 - 432
Filled TOOLGUARD™	434 - 436
Foam inserts	437 - 450



NEXT GEN SDS-PLUS DRILL BITS



**SPEED AND HEAVY-DUTY®
FLUTE DESIGN**

**4-CUTTER
SOLID CARBIDE**



**CONVEX
SHANK END**

**PRECISION
GERMAN
ENGINEERING**

**PGM®
RATED**



**TARGET TIP
TECHNOLOGY**

**FULLY-WELDED
HEAD EXPANSION**



SDS-Plus MX4 drill bits - 4 cut

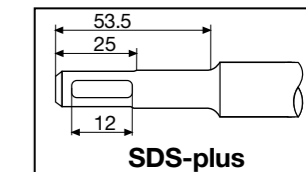

The Milwaukee MX4™ SDS-Plus drill bit is engineered for the toughest applications, featuring innovative fully welded solid carbide tip technology (up to Ø 20 mm) for maximum durability in rebar and unmatched drilling speed in concrete.

4-Cutter solid carbide tip: Enhanced geometry with a sharp centering tip, rebar guards, and new dust grooves delivers clean starts, precise holes, and maximum life when drilling through rebar - even under extreme jobsite conditions.

Optimised flute design with reinforced core: A thicker core combined with alternating SPEED and HEAVY-DUTY spirals ensures fast debris removal, reduced friction, and superior stability in demanding applications.

Convex shank for maximum energy transfer: The convex shank end optimises energy transfer from tool to tip, boosting impact force, drilling efficiency, and jobsite productivity.

One-Piece slotted carbide tip for Ø > 20 mm: For large-diameter concrete drilling, this design offers exceptional strength, extended bit life, and break resistance in heavy-duty use.

PGM certified: Meets industry standards for precision and safety, making it the ideal choice for anchor setting.

Made in Germany: Manufactured to the highest standards for uncompromising quality, reliability, and performance on every jobsite.



Diameter (mm)	Total length (mm) A	Working length (mm) B	Pre-drill	Pack quantity	Min. order quantity	Article Number	EAN Code
3.5	115	50		1	1	4932500056	4058546572204
3.5	165	100		1	1	4932500057	4058546572211
4	115	50		1	1	4932500058	4058546572228
4	165	100		1	1	4932500059	4058546572235
5	115	50		1	1	4932352007	4002395366644
5	165	100		1	1	4932352008	4002395368891
5	215	150		1	1	4932478465	4058546346560
5	265	200		1	1	4932478466	4058546346577
5	315	250		1	1	4932478467	4058546346584
5.5	115	50		1	1	4932352009	4002395368907
5.5	165	100		1	1	4932352010	4002395368914
5.5	215	150		1	1	4932478469	4058546346607
5.5	315	250		1	1	4932478470	4058546346614
6	115	50		1	1	4932352011	4002395368921
6	165	100		1	1	4932352012	4002395368938
6	215	150		1	1	4932352013	4002395366705
6	265	200		1	1	4932352014	4002395366712
6	315	250		1	1	4932352015	4002395366729
6.5	115	50		1	1	4932492017	4058546413293
6.5	165	100		1	1	4932430146	4002395378074
6.5	215	150		1	1	4932352016	4002395366736
6.5	265	200		1	1	4932352017	4002395366743
6.5	315	250		1	1	4932352018	4002395366750
6.5	465	400		1	1	4932464596	4058546225414
7	115	50		1	1	4932352019	4002395366767
7	165	100		1	1	4932352020	4002395366774
7	215	150		1	1	4932492018	4058546413309
8	115	50		1	1	4932352021	4002395366781
8	165	100		1	1	4932352022	4002395366798
8	215	150		1	1	4932352023	4002395366804
8	265	200		1	1	4932352024	4002395366811
8	315	250		1	1	4932352712	4002395373703
8	365	300		1	1	4932492019	4058546413316
8	465	400	✓	1	1	4932352713	4002395373710
9	165	100		1	1	4932352944	4002395376025
9	215	150		1	1	4932492020	4058546413323
10	115	50		1	1	4932352025	4002395366828
10	165	100		1	1	4932352026	4002395366835
10	215	150		1	1	4932352027	4002395366842
10	265	200		1	1	4932352028	4002395366859
10	315	250		1	1	4932352029	4002395366866
10	365	300		1	1	4932492021	4058546413330
10	455	400	✓	1	1	4932352030	4002395366873
10	600	540	✓	1	1	4932352945	4002395376032

✓ Pre drill with a short drill bit of the same diameter.

SDS-Plus MX4 drill bits - 4 cut

Diameter (mm)	Total length (mm) A	Working length (mm) B	Pre-drill	Pack quantity	Min. order quantity	Article Number	EAN Code
10	1000	940	✓	1	1	4932352946	4002395376049
11	165	100		1	1	4932492022	4058546413347
11	215	150		1	1	4932492023	4058546413354
12	165	110		1	1	4932352031	4002395366880
12	215	160		1	1	4932352032	4002395366897
12	265	210		1	1	4932352033	4002395366903
12	315	260		1	1	4932352034	4002395366910
12	360	300		1	1	4932492024	4058546413361
12	450	400	✓	1	1	4932352035	4002395366927
12	600	550	✓	1	1	4932352947	4002395376056
12	1000	940	✓	1	1	4932352948	4002395376063
13	165	100		1	1	4932492025	4058546413378
13	215	150		1	1	4932492026	4058546413385
14	165	110		1	1	4932352036	4002395366934
14	215	150		1	1	4932352037	4002395366941
14	265	200		1	1	4932352949	4002395376070
14	315	260		1	1	4932352038	4002395366958
14	380	330		1	1	4932478473	4058546346645
14	450	400	✓	1	1	4932352039	4002395366965
14	600	550	✓	1	1	4932352950	4002395376087
14	1000	950	✓	1	1	4932352951	4002395376094
15	165	100		1	1	4932430725	4002395383863
15	265	200		1	1	4932352952	4002395376100
15	450	400	✓	1	1	4932492027	4058546413392
16	165	110		1	1	4932430726	4002395383870
16	215	160		1	1	4932352953	4002395376117
16	265	210		1	1	4932352819	4002395374779
16	315	260		1	1	4932352954	4002395376124
16	450	400		1	1	4932352820	4002395374786
16	600	540	✓	1	1	4932352955	4002395376131
16	1000	950	✓	1	1	4932352956	4002395376148
17	215	150		1	1	4932478474	4058546346652
18	200	150		1	1	4932478899	4058546361815
18	250	200		1	1	4932356502	4002395320950
18	450	400	✓	1	1	4932356503	4002395320967
18	600	550	✓	1	1	4932492028	4058546413408
18	1000	940	✓	1	1	4932479345	4058546371395
20	250	200		1	1	4932356504	4002395320974
20	450	400	✓	1	1	4932356505	4002395320981
20	600	550	✓	1	1	4932492029	4058546413415
20	1000	940	✓	1	1	4932479346	4058546371401
22	250	200		1	1	4932399332	4002395359608
22	450	400	✓	1	1	4932356506	4002395320998
22	1000	940	✓	1	1	4932479347	4058546371418
24	250	200		1	1	4932356507	4002395321001
24	450	400	✓	1	1	4932356508	4002395321018
24	1000	940	✓	1	1	4932479348	4058546371425
25	250	200		1	1	4932399333	4002395359615
25	450	400	✓	1	1	4932356509	4002395321025
25	1000	940	✓	1	1	4932479349	4058546371432
28	250	200		1	1	4932399334	4002395359622
28	450	400	✓	1	1	4932356510	4002395321032
30	250	200		1	1	4932399335	4002395359639
30	450	400	✓	1	1	4932356511	4002395321049
32	450	400	✓	1	1	4932399336	4002395359646

✓ Pre drill with a short drill bit of the same diameter.

SDS-Plus MX4 drill bits - 4 cut / 10 pack

Diameter (mm)	Total length (mm) A	Working length (mm) B	Pack quantity	Min. order quantity	Article Number	EAN Code
5	115	50	10	1	4932352040	4002395366972
5	165	100	10	1	4932471250	4058546288785
5.5	115	50	10	1	4932471251	4058546288792
5.5	165	100	10	1	4932352041	4002395366989
6	115	50	10	1	4932352042	4002395366996
6	165	100	10	1	4932352043	4002395367009
6	215	150	10	1	4932430234	4002395378951
6	265	200	10	1	4932471252	4058546288808
6.5	165	100	10	1	4932479556	4058546373504
6.5	215	150	10	1	4932430235	4002395378968
6.5	265	200	10	1	4932459588	4058546027605
7	165	100	10	1	4932352044	4002395367016
8	115	50	10	1	4932352045	4002395367023
8	165	100	10	1	4932352046	4002395367030
8	215	150	10	1	4932464872	4058546228170
8	265	200	10	1	4932471253	4058546288815
10	165	100	10	1	4932352047	4002395367047
10	215	150	10	1	4932352048	4002395367054
10	265	200	10	1	4932471254	4058546288822
10	315	250	10	1	4932471255	4058546288839
12	165	100	10	1	4932352049	4002395367061
12	215	150	10	1	4932352050	4002395367078
12	265	200	10	1	4932471256	4058546288846
14	215	150	10	1	4932471257	4058546288853
16	265	200	10	1	4932471258	4058546288860

SDS-Plus MX4 drill bits - 4 cut / 50 pack

Diameter (mm)	Total length (mm) A	Working length (mm) B	Pack quantity	Min. order quantity	Article Number	EAN Code
5.5	165	100	50	1	4932472234	4058546326302
6	115	50	50	1	4932430437	4002395380985
6	165	100	50	1	4932430438	4002395380992
6	215	150	50	1	4932430462	4002395381234
6.5	165	100	50	1	4932479557	4058546373511
6.5	215	150	50	1	4932430463	4002395381241
6.5	265	200	50	1	4932459589	4058546027612
7	115	50	50	1	4932472154	4058546325503
7	165	100	50	1	4932472155	4058546325510
8	115	50	50	1	4932479368	4058546371623
8	165	100	50	1	4932430439	4002395381005
8	215	150	50	1	4932430440	4002395381012
8	315	250	50	1	4932472156	4058546325527
8	465	400	50	1	4932472157	4058546325534
10	115	50	50	1	4932479369	4058546371630
10	165	100	50	1	4932430441	4002395381029
10	215	150	50	1	4932430442	4002395381036
10	315	250	50	1	4932472158	4058546325541
10	455	390	50	1	4932472159	4058546325558
12	165	100	50	1	4932472160	4058546325565
12	215	150	50	1	4932430443	4002395381043
12	315	250	50	1	4932472161	4058546325572
12	450	400	50	1	4932472162	4058546325589
14	210	150	50	1	4932478097	4058546340308

SDS-Plus MX4 drill bits - 4 cut / sets

Description	Supplied in	Pack quantity	Min. order quantity	Article Number	EAN Code
SDS-Plus MX4 drill bit set (5pc)	Plastic cassette	5	12	4932500063	4058546572273
① Ø 5 / 6 x 115 mm, Ø 6 / 8 x 165 mm, Ø 10 x 165 mm					
SDS-Plus MX4 drill bit set (5pc)	Plastic cassette	5	12	4932500064	4058546572280
① Ø 5.5 x 115 mm, Ø 5.5 / 6 / 7 / 8 x 165 mm					
SDS-Plus MX4 drill bit set (7pc)	Plastic cassette	7	6	4932500060	4058546572242
② Ø 5 / 6 x 115 mm, Ø 6 / 8 / 8 / 10 x 165 mm, Ø 12 x 160 mm					
SDS-Plus MX4 drill bit set (7pc)	Plastic cassette	7	6	4932500061	4058546572259
② Ø 5.5 / 6 x 115 mm, Ø 5 / 5.5 / 6 / 8 / 10 x 165 mm					
SDS-Plus MX4 drill bit set (10pc)	Plastic cassette	10	6	4932500062	4058546572266
② Ø 5 / 6 / 6 x 115 mm, Ø 6 / 6 / 8 / 8 / 8 / 10 / 12 x 165 mm					



**DESIGNED FOR USE IN
PACKOUT™**



PROFESSIONAL
FAST DRILLING IN CONCRETE



**25%
FASTER**
3 BREAKER POINTS

*vs. previous generation



**2
VARIABLE
FLUTE
DESIGN**



**2
CUTTER**
IDEAL IN CONCRETE
DRILLING APPLICATIONS
WITH CORDLESS HAMMERS

SDS-Plus M2 drill bits - 2 cut



Made in Germany

FASTEST: New aggressive tip geometry with 3 chip breakers demolishes the concrete quicker and a tapered shoulder design minimises friction enabling the M2 drill bit to deliver faster drilling speed

DURABILITY: Rebar chamfers on the tip prevent side tip damage when hitting metal reinforcement and a thicker core body ensures higher power transfer, lower vibrations and less flute breakages

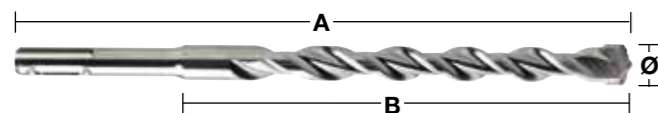
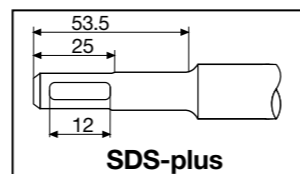

Diameter (mm)	Total length (mm) A	Working length (mm) B	Pre-drill	Pack quantity	Min. order quantity	Article Number	EAN Code
3	110	50		1	1	4932352892	4002395375509
3.5	110	50		1	1	4932373908	4002395353378
4	110	50		1	1	4932339498	4002395304561
4	160	100		1	1	4932399143	4002395357505
4.8	110	50		1	1	4932352130	4002395367832
5	110	50		1	1	4932307067	4002395308835
5	160	100		1	1	4932399315	4002395359431
5	210	150		1	1	4932399316	4002395359448
5.5	110	50		1	1	4932339499	4002395304578
5.5	160	100		1	1	4932340408	4002395311910
5.5	210	150		1	1	4932399317	4002395359455
5.5	260	200		1	1	4932399318	4002395359462
5.5	310	250		1	1	4932399319	4002395359479
5.5	410	350		1	1	4932399320	4002395359486
6	110	50		1	1	4932307068	4002395308842
6	160	100		1	1	4932307069	4002395308859
6	210	150		1	1	4932373136	4002395346394
6	260	200		1	1	4932353819	4002395320127
6	310	250		1	1	4932399321	4002395359493
6	460	400	✓	1	1	4932399322	4002395359509
6.5	110	50		1	1	4932344292	4002395312276
6.5	160	100		1	1	4932344293	4002395312269
6.5	210	150		1	1	4932399147	4002395357574
6.5	260	200		1	1	4932399148	4002395357581
6.5	310	260		1	1	4932399323	4002395359516
7	110	50		1	1	4932353820	4002395320134
7	160	100		1	1	4932340409	4002395311927
7	210	150		1	1	4932399222	4002395358366
7	250	200		1	1	4932399324	4002395359523
8	110	50		1	1	4932307070	4002395308866
8	160	100		1	1	4932307071	4002395308873
8	210	150		1	1	4932307072	4002395308880
8	260	200		1	1	4932353821	4002395320141
8	310	250		1	1	4932399325	4002395359530
8	400	350		1	1	4932399326	4002395359547
8	460	400	✓	1	1	4932367013	4002395336692
8	600	540	✓	1	1	4932399327	4002395359554
8	1000	940	✓	1	1	4932399328	4002395359561
9	160	100		1	1	4932353823	4002395320165
9	210	150		1	1	4932353822	4002395320158
10	110	50		1	1	4932340410	4002395311934
10	160	100		1	1	4932307073	4002395308897
10	210	150		1	1	4932307074	4002395308903
10	260	200		1	1	4932344295	4002395312252
10	310	250		1	1	4932353824	4002395320172
10	450	400	✓	1	1	4932344296	4002395312245
10	600	550	✓	1	1	4932367014	4002395336708
10	1000	950	✓	1	1	4932367015	4002395336715

✓ Pre drill with a short drill bit of the same diameter.

SDS-Plus M2 drill bits - 2 cut



Diameter (mm)	Total length (mm) A	Working length (mm) B	Pre-drill	Pack quantity	Min. order quantity	Article Number	EAN Code
11	160	100		1	1	4932367066	4002395336722
11	260	210		1	1	4932399329	4002395359578
12	160	110		1	1	4932307075	4002395308910
12	210	160		1	1	4932307076	4002395308927
12	260	210		1	1	4932344297	4002395312238
12	310	260		1	1	4932353825	4002395320189
12	450	400	✓	1	1	4932307077	4002395308934
12	600	550	✓	1	1	4932367068	4002395336746
12	1000	950	✓	1	1	4932367017	4002395336760
13	160	110		1	1	4932307946	4002395309054
13	260	210		1	1	4932344298	4002395312221
14	160	110		1	1	4932307078	4002395308941
14	210	160		1	1	4932353826	4002395320196
14	260	210		1	1	4932307079	4002395308958
14	310	260		1	1	4932399330	4002395359585
14	450	400	✓	1	1	4932307088	4002395309047
14	600	550	✓	1	1	4932367018	4002395336777
14	1000	950	✓	1	1	4932367019	4002395336784
15	160	110		1	1	4932373910	4002395353392
15	260	210		1	1	4932344300	4002395312207
16	160	110		1	1	4932307080	4002395308965
16	210	160		1	1	4932307081	4002395308972
16	260	210		1	1	4932399331	4002395359592
16	310	260		1	1	4932344301	4002395312191
16	450	400	✓	1	1	4932307082	4002395308989
16	600	550	✓	1	1	4932367069	4002395336791
16	1000	950	✓	1	1	4932367021	4002395336814
18	200	150		1	1	4932344303	4002395312177
18	250	200		1	1	4932307083	4002395308996
18	300	250		1	1	4932344304	4002395312160
18	450	400	✓	1	1	4932340411	4002395311941
18	600	550	✓	1	1	4932367022	4002395336821
18	1000	950	✓	1	1	4932367024	4002395336845
20	200	150		1	1	4932344305	4002395312153
20	250	200		1	1	4932307084	4002395309009
20	300	250		1	1	4932399027	4002395356126
20	450	400	✓	1	1	4932307085	4002395309016
20	600	550	✓	1	1	4932367025	4002395336876
20	1000	950	✓	1	1	4932367026	4002395336883
22	250	200		1	1	4932373911	4002395353408
22	450	400	✓	1	1	4932344307	4002395312139
22	600	550	✓	1	1	4932367027	4002395336890
22	1000	950	✓	1	1	4932367029	4002395336913
24	250	200		1	1	4932373922	4002395353521
24	450	400	✓	1	1	4932307087	4002395309030
25	250	200		1	1	4932344308	4002395312122
25	450	400	✓	1	1	4932344309	4002395312115
25	1000	950	✓	1	1	4932367030	4002395336975
26	250	200		1	1	4932344310	4002395323814
26	450	400	✓	1	1	4932344311	4002395312092

✓ Pre drill with a short drill bit of the same diameter.

SDS-Plus M2 drill bits - 2 cut / 10 pack

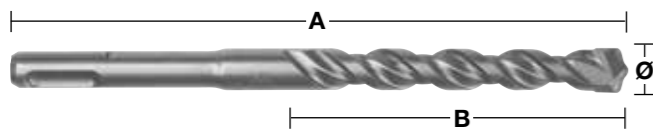

Diameter (mm)	Total length (mm) A	Working length (mm) B	Pack quantity	Min. order quantity	Article Number	EAN Code
5	110	50	10	1	4932371702	4002395344017
5	160	100	10	1	4932352520	4002395371785
5.5	110	50	10	1	4932352521	4002395371792
5.5	160	100	10	1	4932371703	4002395344024
6	110	50	10	1	4932371704	4002395344031
6	160	100	10	1	4932371705	4002395344048
6	210	150	10	1	4932399337	4002395359653
6.5	160	100	10	1	4932399338	4002395359660
6.5	210	150	10	1	4932399339	4002395359677
6.5	260	200	10	1	4932399340	4002395359684
7	160	100	10	1	4932373225	4002395348619
8	160	100	10	1	4932371706	4002395344055
8	210	150	10	1	4932399341	4002395359691
10	110	50	10	1	4932352522	4002395371808
10	160	100	10	1	4932371708	4002395344079
10	210	150	10	1	4932371709	4002395344086
10	260	200	10	1	4932399342	4002395359707
12	160	100	10	1	4932399343	4002395359714
12	210	160	10	1	4932371710	4002395344093
12	260	210	10	1	4932399344	4002395359721
14	260	210	10	1	4932371711	4002395344109

SDS-Plus M2 drill bits - 2 cut / 50 pack



Diameter (mm)	Total length (mm) A	Working length (mm) B	Pack quantity	Min. order quantity	Article Number	EAN Code
5	110	50	50	1	4932399176	4002395357833
5.5	160	100	50	1	4932399177	4002395357840
6	110	50	50	1	4932399178	4002395357857
6	160	100	50	1	4932399179	4002395357864
7	160	110	50	1	4932399181	4002395357888
8	160	100	50	1	4932399182	4002395357895
8	210	150	50	1	4932399183	4002395357901
10	160	110	50	1	4932399345	4002395359738
10	210	150	50	1	4932399184	4002395357918
10	260	200	50	1	4932399185	4002395357925
12	210	160	50	1	4932399186	4002395357932

SDS-Plus M2 drill bits - 2 cut / cassettes



Description	Pack quantity	Min. order quantity	Article Number	EAN Code
① SDS-Plus M2 drill bit set (5pc) Ø 5 / 6 x 110 mm and Ø 6 / 8 / 10 x 160 mm	5	1	4932352338	4002395369973
① SDS-Plus M2 drill bit set (5pc) Ø 5.5 x 110 mm and Ø 5.5 / 6 / 7 / 8 x 160 mm	5	1	4932352834	4002395374922
① SDS-Plus M2 drill bit set (5pc) Ø 10 / 12 / 14 / 16 / 20 x 450 mm	5	1	4932352801	4002395374595
② SDS-Plus M2 drill bit set (7pc) Ø 5 / 6 / 8 x 110 mm and Ø 6 / 8 / 10 / 12 x 160 mm	7	6	4932492116	4058546414832
② SDS-Plus M2 drill bit set (10pc) Ø 5 / 5 / 6 / 6 x 110 mm and Ø 6 / 6 / 8 / 8 / 10 / 12 x 160 mm	10	6	4932492117	4058546414849
③ Drill bit and chisel set (5pc) SDS-Plus drill bits Ø 6 / 8 / 10 x 160 mm, pointed and flat chisel	5	1	4932430002	4002395376636



INVESTMENT IN CARBIDE



RESEARCH DEVELOPMENT
NEW TECHNOLOGIES

PROTOTYPING
RAPID PROTOTYPING



TESTING
COMPREHENSIVE TESTING

PRODUCTION
BEST IN CLASS PRODUCTION



SDS-PLUS

SDS-MAX

CHISELS



MADE IN GERMANY

SDS-Plus extensions

Universal SDS-Plus extensions to extend the reach of SDS-Plus drill bits.
Tool free drill bit click & connect system.
Fits to all SDS-Plus rotary hammers and drill bits.
Optimal for drilling around obstructions such as previously installed pipes and for overhead drilling.
Allows deep hole drilling e.g. rebar applications without buying an expensive long drill bit.
Diameter of the quick lock mechanism: 21 mm.



Length (mm)	Pack quantity	Min. order quantity	Article Number	EAN Code
300	1	1	4932471153	4058546287818
450	1	1	4932471154	4058546287825



DUST MANAGEMENT

Accurate concentricity and high dimensional accuracy drilled holes, according to PGM Conformity

Faster and more efficient drilling due to **99% dust removal**

Efficient drilling without dust for a safer and cleaner working environment

Active drill bit heads **cooling for a longer life**



SDS-Plus DUST-LOK dustless drill bits - 4 cut - Modular design

Efficient drilling without dust for a safer and cleaner work environment.
Captures 99% of drilled dust.
Active drill bit head cooling for a longer life.
4 cutter design prevents the drill bit from jamming in the rebar.
Accurate concentricity and high dimensional accuracy drilled holes, according to PGM.
Universal connector for all common vacuum cleaners with hose diameter 32 - 38 mm.

	Diameter (mm)	Total length (mm) A	Working length (mm) B	Pack quantity	Min. order quantity	Article Number	EAN Code
①	5	136	100	1	1	4932471155	4058546287832
②	6	136	100	1	1	4932471156	4058546287849
③	8	136	100	1	1	4932471157	4058546287856
④	10	136	100	1	1	4932471158	4058546287863
⑤	12	136	100	1	1	4932471159	4058546287870
⑥	SDS-Plus DC arbor with vacuum adapter			1	1	4932471160	4058546287887
SDS-Plus DC dustless drill bit set (6pc)							
⑦	Ø 5 / 6 / 8 / 10 / 12 x 136 mm. 1 x arbor with vacuum adapter			7	1	4932471162	4058546287900



Scan the QR Code to see our full video.



SDS-Plus dustless drill bits - 2 cut - 2 piece design

Faster and more efficient drill bit due to effective dust removal.
Efficient drilling without dust for a safer and cleaner working environment.
Active drill bit head cooling for a longer life. Accurate concentricity and high dimensional accuracy drilled holes, according to PGM Conformity.
Universal connector for all common vacuum cleaners with hose diameter 32 – 38 mm.

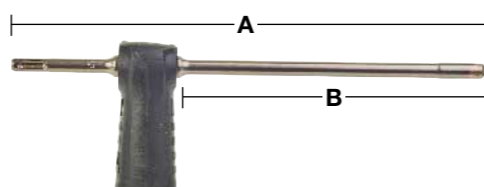

Diameter (mm)	Total length (mm) A	Working length (mm) B	Pack quantity	Min. order quantity	Article Number	EAN Code
12	325	200	1	1	4932459283	4058546002497
14	360	240	1	1	4932459284	4058546002503
16	360	240	1	1	4932459285	4058546002510

SDS-Max dustless drill bits - 4 cut - One piece design

Faster and more efficient drilling due to 99% dust removal.
Efficient drilling without dust for a safer and cleaner working environment.
Active drill bit head cooling for a longer life.
4 cutter design prevents the drill bit from jamming in the rebar.
Accurate concentricity and high dimensional accuracy drilled holes, according to PGM Conformity.
Universal connector for all common vacuum cleaners with hose diameter 32 – 38 mm.

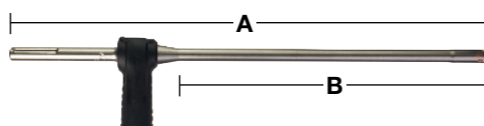

Diameter (mm)	Total length (mm) A	Working length (mm) B	Pack quantity	Min. order quantity	Article Number	EAN Code
16	600	400	1	1	4932459287	4058546002534
18	600	400	1	1	4932459288	4058546002541
20	600	400	1	1	4932459289	4058546002558
22	600	400	1	1	4932459290	4058546002565
24	600	400	1	1	4932459291	4058546002572
25	600	400	1	1	4932459292	4058546002589
28	600	400	1	1	4932459293	4058546002596
28	900	900	1	1	4932459294	4058546002602
30	600	400	1	1	4932459295	4058546002619
30	900	700	1	1	4932459296	4058546002626
32	600	400	1	1	4932459297	4058546002633
32	900	700	1	1	4932459298	4058546002640
35	900	700	1	1	4932459300	4058546002664
Universal vacuum cleaner adaptor			1	1	4931416173	4002395805501

Dust guard

Prevents dust and dirt entering the tool reception area when using spades and ground rod drivers.

Description	Pack quantity	Min. order quantity	Article Number	EAN Code
Dust guard cap	1	1	9170086960	4002395565504



Rotary hammer dust extraction

Description	Pack quantity	Min. order quantity	Article Number	EAN Code
① Dust collection ring for collecting dust when overhead drilling. Suitable for Ø 5 - 8 mm	1	1	4932430912	4002395385744

①



② Extractor for dust collection on the wall or when overhead drilling. Maximum diameter drill bit Ø 28 mm. Fits to all industrial dust extraction units (universal reception Ø 26 – 41 mm)	1	1	4932430446	4002395381074
--	---	---	------------	---------------

②



③ Drilling shroud - PHDE72. For drilling and coring from Ø 6 - 72 mm. Brush insert to improve suction and extraction. Brushes to be removed for coring applications. Outlet nozzle: Ø 37 mm outside / Ø 32 mm inside. Replacement sealing lips (2 pcs): 4931448564. Replacement brush: 4931448565	1	1	4932430480	4002395381418
---	---	---	------------	---------------

③



④ Drilling shroud - PHDE152	1	1	4932471990	4058546298890
-----------------------------	---	---	------------	---------------

④



⑤ DE16 unit, 1 x side handle and 3 x neck collars - allows fitting to drills with gear neck from Ø 43 - 59 mm. 2 x drilling nozzles (49902301)	1	1	4932430835	4002395384976
--	---	---	------------	---------------

⑤



SDS-Plus dust trap

Universal fit - Fits ALL SDS-Plus rotary hammer brands and styles.
 Fits ALL SDS-Plus drill bits up to 215mm total length.
 Fits ALL standard vacuum cleaners.
 Clear sleeve for visibility & accuracy.
 Collects up to 99% of airborne dust.
 Useable with or without vacuum cleaner.

Description	Pack quantity	Min. order quantity	Article Number	EAN Code
SDS-Plus dust trap	1	1	4932464916	4058546228613
SDS-Plus dust trap sleeve	1	1	4932464917	4058546228620



SDS-Max chisel boot

Universal fit - Fits ALL standard SDS-Max rotary hammer brands and styles.
 Universal fit to pointed and flat chisels up to 400mm length and 25mm tip width.
 Slim design for reaching tight areas.
 Hose clip adapter for easy attachment to MILWAUKEE® vacuum cleaners.

Description	Pack quantity	Min. order quantity	Article Number	EAN Code
SDS-Max chisel boot	1	1	4932471991	4058546298906



Breaker boot

Universal fit - Fits most 28 & 30 mm breaking hammers. Perfect match to 28 mm MX FUEL™ breaker.
 Universal fit to pointed and flat chisels.
 Slim design for reaching tight areas.
 Hose clip adapter for easy attachment to MILWAUKEE® vacuum cleaners.

Description	Pack quantity	Min. order quantity	Article Number	EAN Code
Breaker boot	1	1	4932471992	4058546298913



SDS-Plus TCT core cutters

Core cutters for rotary hammers up to 4 kg.
 All TCT cores have a M16 x 2 thread and fit to both SDS-Plus and Hex 11 arbors.
 Arbor and pilot drill bit required additionally.
 Made in Germany.
 Not suitable for reinforced concrete.

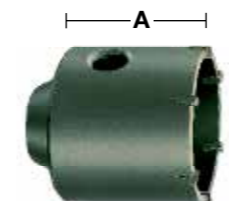
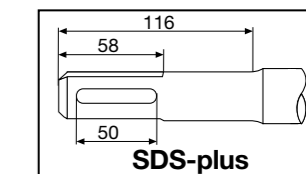

Diameter (mm)	Total length (mm) A	Pack quantity	Min. order quantity	Article Number	EAN Code
35	58	1	1	4932344478	4002395312559
50	58	1	1	4932344479	4002395312566
65	50	1	1	4932344480	4002395312573
68	50	1	1	4932399099	4002395357031
82	50	1	1	4932344481	4002395312580
90	50	1	1	4932344482	4002395312597
100	50	1	1	4932480689	4058546409746

SDS-Plus TCT core cutter - set

Set version includes: TCT core cutter, SDS-Plus arbor 105 mm length, TCT pilot drill bit Ø 8 x 120 mm and allen key.

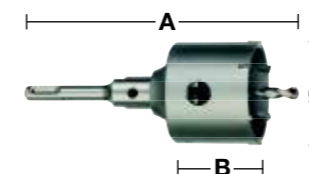

Diameter (mm)	Total length (mm) A	Working length (mm) B	Pack quantity	Min. order quantity	Article Number	EAN Code
65	182	50	4	1	4932399295	4002395359097
68	182	50	4	1	4932399296	4002395359103
82	182	50	4	1	4932399297	4002395359110

SDS-Plus TCT core cutter arbors

Both SDS-Plus and Hex arbors include an allen key and require a pilot drill bit additionally.

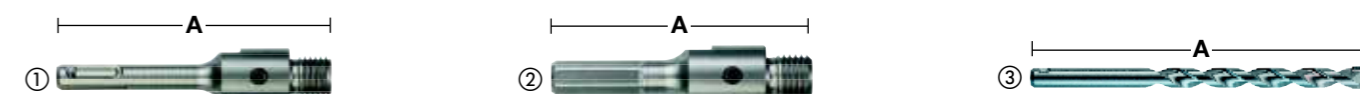

Description	Reception	Diameter (mm)	Total length (mm) A	Pack quantity	Min. order quantity	Article Number	EAN Code
① SDS-plus arbor	SDS-Plus		105	2	1	4932399966	4002395366255
① SDS-plus arbor	SDS-Plus		370	2	1	4932399967	4002395366262
② Hex arbor	11 mm Hex		90	2	1	4932399968	4002395366279
③ TCT pilot drill bit for use in masonry, concrete, brick etc.		8	120	1	1	4932399125	4002395357291



DRILL TO THE MAX.

SDS-MAX MX4™ DRILL BITS

MILWAUKEE® Tool leads the way in accessories development and technology for the professional job site. Our relentless pursuit of innovation has resulted in the Next Generation MX4™ SDS-MAX drill bits, our most powerful and durable drill bit for toughest tasks on the job site.

Driven and developed by countless hours on the jobsite, MILWAUKEE® has created MX4™ SDS-MAX as a drill bit designed to offer the fastest performance and longest lifespan when drilling in reinforced concrete. Featuring MILWAUKEE® exclusive Target Tip Technology, SDS-MAX is larger than the standard SDS-PLUS bits, providing improved accuracy and performance in rebar as well as other heavy-duty applications.

NEW
TARGET TIP TECHNOLOGY
SHARPER ANGLED TIP
IMPROVED REBAR PERFORMANCE

2x
LIFE IN REBAR*

* Vs previous generation

4 VARIABLE FLUTE DESIGN*
FOR FASTER DRILLING

PRECISION GERMAN ENGINEERING

NEW TARGET TIP TECHNOLOGY

PGM RATED
FOR PRECISE DRILLING

*Variable 4 flute design for diameters up to 16mm, all larger diameters have a variable 2 flute design.

SDS-Max MX4 drill bits - 4 cut

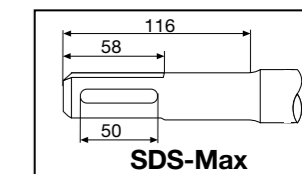
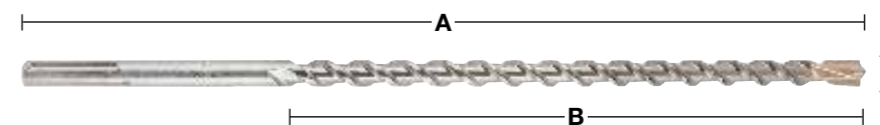

Diameter (mm)	Total length (mm) A	Working length (mm) B	Pre-drill	Pack quantity	Min. order quantity	Article Number	EAN Code
12	340	200		1	1	4932352750	4002395374083
12	540	400	✓	1	1	4932352751	4002395374090
12	740	550		1	1	4932430727	4002395383887
14	340	200		1	1	4932352752	4002395374106
14	540	400	✓	1	1	4932352753	4002395374113
15	340	200		1	1	4932352754	4002395374120
15	540	400	✓	1	1	4932352755	4002395374137
16	340	200		1	1	4932352756	4002395374144
16	540	400	✓	1	1	4932352757	4002395374151
16	940	800	✓	1	1	4932352758	4002395374168
16	1320	1180	✓	1	1	4932352759	4002395374175
18	340	200		1	1	4932352760	4002395374182
18	540	400	✓	1	1	4932352761	4002395374199
18	940	800	✓	1	1	4932352762	4002395374205
18	1320	1180	✓	1	1	4932352763	4002395374212
20	320	200		1	1	4932352764	4002395374229
20	520	400	✓	1	1	4932352765	4002395374236
20	920	800	✓	1	1	4932352766	4002395374243
20	1320	1200	✓	1	1	4932352767	4002395374250
22	320	200		1	1	4932352768	4002395374267
22	520	400	✓	1	1	4932352769	4002395374274
22	920	800	✓	1	1	4932352770	4002395374281
22	1320	1200	✓	1	1	4932352771	4002395374298
24	320	200		1	1	4932352772	4002395374304
24	520	400	✓	1	1	4932352773	4002395374311
25	320	200		1	1	4932352774	4002395374328
25	520	400	✓	1	1	4932352775	4002395374335
25	920	800	✓	1	1	4932352776	4002395374342
25	1320	1200	✓	1	1	4932352777	4002395374359
26	520	400		1	1	4932430728	4002395383894
28	370	250		1	1	4932352778	4002395374366
28	570	450	✓	1	1	4932352779	4002395374373
28	670	550	✓	1	1	4932352780	4002395374380
28	920	800	✓	1	1	4932352781	4002395374397
28	1320	1200	✓	1	1	4932352782	4002395374403
30	370	250		1	1	4932352783	4002395374410
30	570	450		1	1	4932352784	4002395374427
30	920	800		1	1	4932430729	4002395383900
32	370	250		1	1	4932352785	4002395374434
32	570	450		1	1	4932352786	4002395374441
32	920	800	✓	1	1	4932352787	4002395374458
32	1320	1200	✓	1	1	4932352788	4002395374465
35	370	250		1	1	4932352789	4002395374472
35	570	450		1	1	4932352790	4002395374489
35	920	800	✓	1	1	4932352791	4002395374496
38	370	250		1	1	4932352792	4002395374502
38	570	450		1	1	4932352793	4002395374519
40	370	250		1	1	4932352794	4002395374526
40	570	450	✓	1	1	4932352795	4002395374533
40	920	800	✓	1	1	4932352796	4002395374540
40	1320	1200	✓	1	1	4932352797	4002395374557
45	570	450		1	1	4932352798	4002395374564
45	920	800		1	1	4932430730	4002395383917
50	570	450		1	1	4932430731	4002395383924
52	570	450		1	1	4932352799	4002395374571
SDS-Max drill bits set (5pc) Ø 16 / 18 x 540 mm, Ø 20 / 22 / 25 x 520 mm				5	1	4932352800	4002395374588

✓ Pre drill with a short drill bit of the same diameter.

additional length available upon request

SDS-Max TCT tunnel drill bits - One piece design

One piece solid steel tool.
Premium 3 cutter centering drill bit.
Massive head with 3 large dust removal channels.
Rebar chamfers to prevent side tip damage when hitting metal reinforcement.
Suitable for reinforced concrete.
Made in Germany.

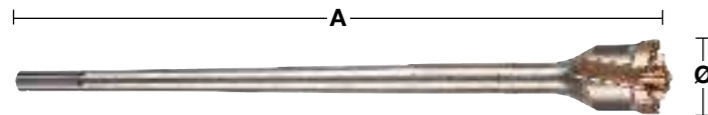
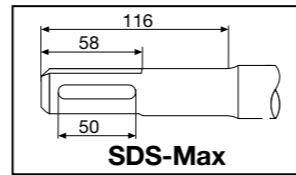

Diameter (mm)	Total length (mm) A	Pack quantity	Min. order quantity	Article Number	EAN Code
40	550	1	1	4932492053	4058546414207
45	550	1	1	4932492054	4058546414214
45	990	1	1	4932492055	4058546414221
55	550	1	1	4932492056	4058546414238
55	990	1	1	4932492057	4058546414245
65	550	1	1	4932492058	4058546414252
65	990	1	1	4932492059	4058546414269
80	550	1	1	4932492060	4058546414276
80	990	1	1	4932492061	4058546414283

SDS-Max TCT core cutters - One piece design

One piece solid steel tool.
Increased lifetime.
Supplied with pilot drill bit and ejector tool.
Made in Germany.
Suitable for use in reinforced concrete with rebar.

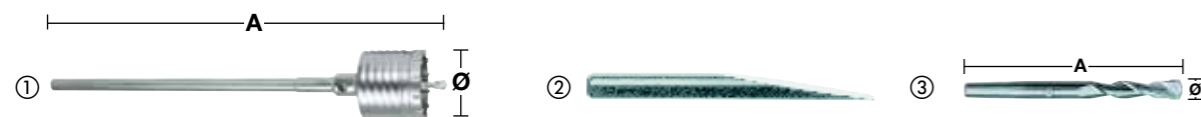

Description	Diameter (mm)	Total length (mm) A	Pack quantity	Min. order quantity	Article Number	EAN Code
①	50	290	1	1	4932399373	4002395359905
	50	550	1	1	4932373884	4002395353132
	68	290	1	1	4932399374	4002395359912
	68	550	1	1	4932373885	4002395353149
	80	290	1	1	4932399375	4002395359929
	80	550	1	1	4932373886	4002395353156
	100	550	1	1	4932373888	4002395353170
	125	550	1	1	4932373889	4002395353187
	150	550	1	1	4932373890	4002395353194
② Ejector tool			1	1	4932399021	4002395356065
③ Pilot drill bit	11	120	1	1	4932245967	4002395307111

SDS-Max TCT core cutters - Two piece design

Not suitable for rotary hammers > 10 kg.
Made in Germany.
Not suitable for reinforced concrete.

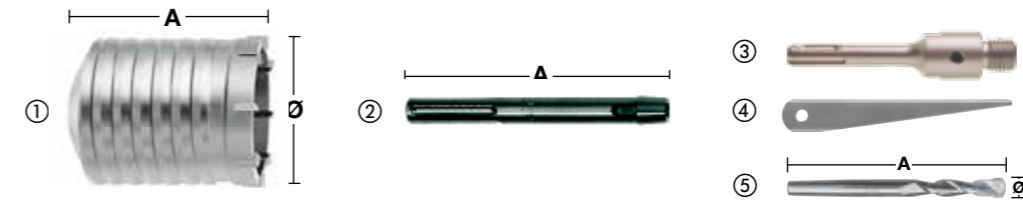
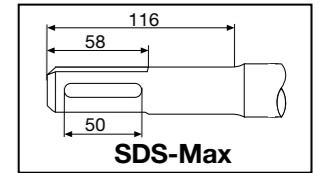

Description	Diameter (mm)	Total length (mm) A	Pack quantity	Min. order quantity	Article Number	EAN Code
① TCT core cutter	40	100	1	1	4932245992	4002395307180
	50	100	1	1	4932430732	4002395383931
	60	100	1	1	4932430733	4002395383948
	65	100	1	1	4932245994	4002395307203
	68	100	1	1	4932430734	4002395383955
	80	100	1	1	4932245995	4002395307210
	90	100	1	1	4932430735	4002395383962
	100	100	1	1	4932367304	4002395336432
	125	100	1	1	4932367306	4002395336456
	150	100	1	1	4932367308	4002395336470
② Arbor SDS-Max	-	180	1	1	4932343667	4002395315932
	-	450	1	1	4932343670	4002395315949
③ SDS+ Arbor for SDS-Max TCT core cutters		115	1	1	4932480690	4058546409753
④ Ejector tool	-	-	1	1	4932604214	4002395311231
⑤ Pilot drill bit	11	120	1	1	4932245967	4002395307111

SDS-Max to SDS-Plus chuck adaptor



Description	Tool reception	Drill reception	Pack quantity	Min. order quantity	Article Number	EAN Code
SDS-Max to SDS-Plus chuck adaptor	SDS-Max	SDS-Plus	1	1	4932359490	4002395325795

SDS-Max vario extension system

Flexible tool system: can be extended to variable lengths in combination with core cutters or tunnel bits. We recommend a maximum of 3 extensions.

Cost effective: different drill sizes can be exchanged easily and fast with the threaded stud system.

Suitable for rotary hammers up to 8 kg.

Vario tunnel bits (supplied with thread).

Not suitable for reinforced concrete.

Description	Diameter (mm)	Total length (mm) A	Pack quantity	Min. order quantity	Article Number	EAN Code
① SDS-Max arbor with internal thread	-	195	1	1	4932430736	4002395383979
② Vario extension (incl. threaded stud)	25	280	1	1	4932430737	4002395383986
③ Vario threaded stud	-	-	1	1	4932430738	4002395383993
④ Vario threaded stud with tapered end 1:8 for TCT core cutters	-	-	1	1	4932430748	4002395384099
⑤ TCT core cutter	40	100	1	1	4932245992	4002395307180
	50	100	1	1	4932430732	4002395383931
	60	100	1	1	4932430733	4002395383948
	65	100	1	1	4932245994	4002395307203
	68	100	1	1	4932430734	4002395383955
	80	100	1	1	4932245995	4002395307210
	90	100	1	1	4932430735	4002395383962
	100	100	1	1	4932367304	4002395336432
	125	100	1	1	4932367306	4002395336456
	150	100	1	1	4932367308	4002395336470
⑥ Ejector tool	-	-	1	1	4932604214	4002395311231
⑦ Pilot drill bit	11	120	1	1	4932245967	4002395307111
⑧ Vario tunnel drill bits (supplied with thread)	30	150	1	1	4932430739	4002395384006
	35	150	1	1	4932430740	4002395384013
	40	150	1	1	4932430743	4002395384044
	45	150	1	1	4932430744	4002395384051
	55	150	1	1	4932430745	4002395384068
	60	150	1	1	4932430741	4002395384020
	68	150	1	1	4932430746	4002395384075
	80	150	1	1	4932430747	4002395384082
	90	150	1	1	4932430742	4002395384037

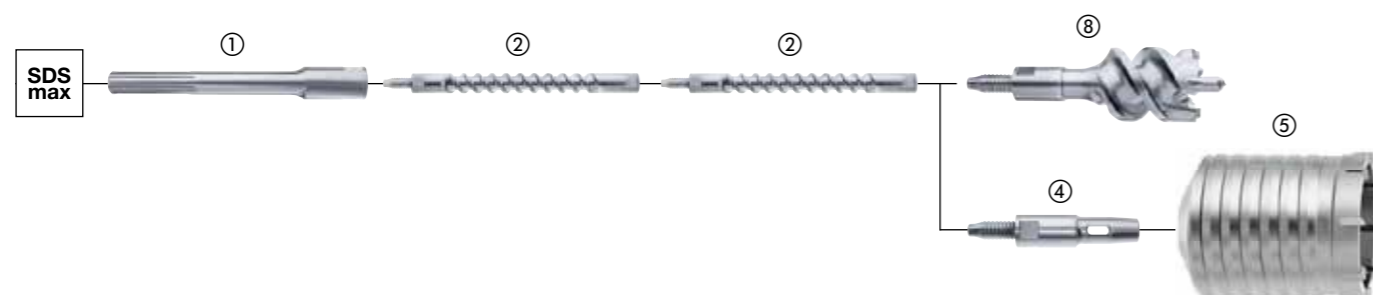
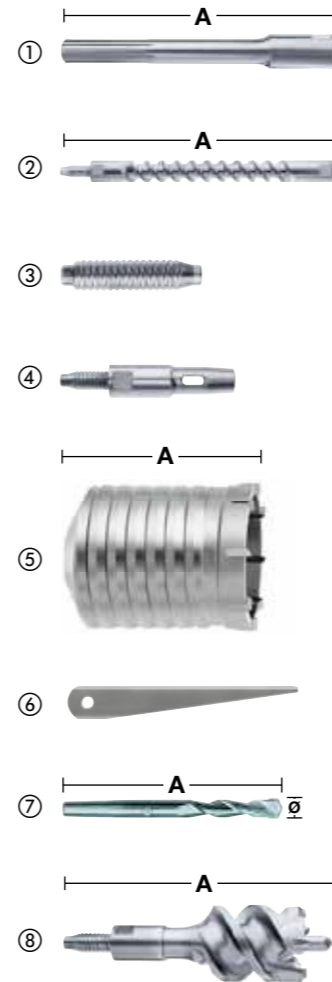

Drill Connect

The innovative Drill Connect System is the ultimate solution for those requiring maximum versatility with large diameter drilling tools.

Versatile:

Drill Connect acts as a link between machine and drilling tools. On one side the system is totally compatible to all SDS-Max reception drilling tools such as drill bits, tunnel bits and core cutters. On the opposite side, between the rotary hammer and the Drill Connect attachment, one can fit the extension piece with the desired length.

Cost effective:

Professional users always require both long and short length drill bits and depending on the application sometimes even of the same diameter. But now, one can reduce the total number of drilling tools with the help of the Drill Connect System which makes it possible to interchange the drilling tools diameter and length in one simple step. Therefore users can reap the benefits of purchasing the cheaper short length drill bits and extending the length with the economical extensions plus the flexibility of Drill Connect reduces the overall quantity of drill bits one must carry in their toolbox.

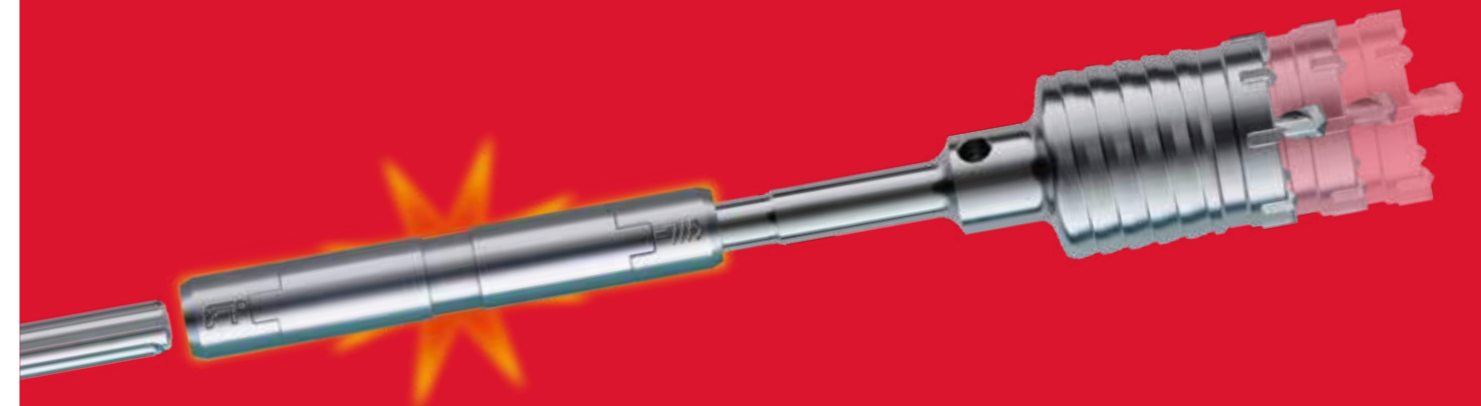

100% Power:

The Drill Connect attachment provides a quick and safe connection between drilling tool and extension piece and therefore ensures that 100% of the power is completely transmitted to the drill bit tip.

Less weight:

The combination of short drilling tools and 18 mm diameter extensions reduces the overall weight by up to 15%.

- We recommend that Drill Connect be cleaned of concrete dust and lubricated with grease at regular intervals (Grease – Part-no. 4932352273).
- Drill Connect is only suitable for drilling tools in excess of 32 mm diameter and limited for use with rotary hammers up to 8 kg in weight.

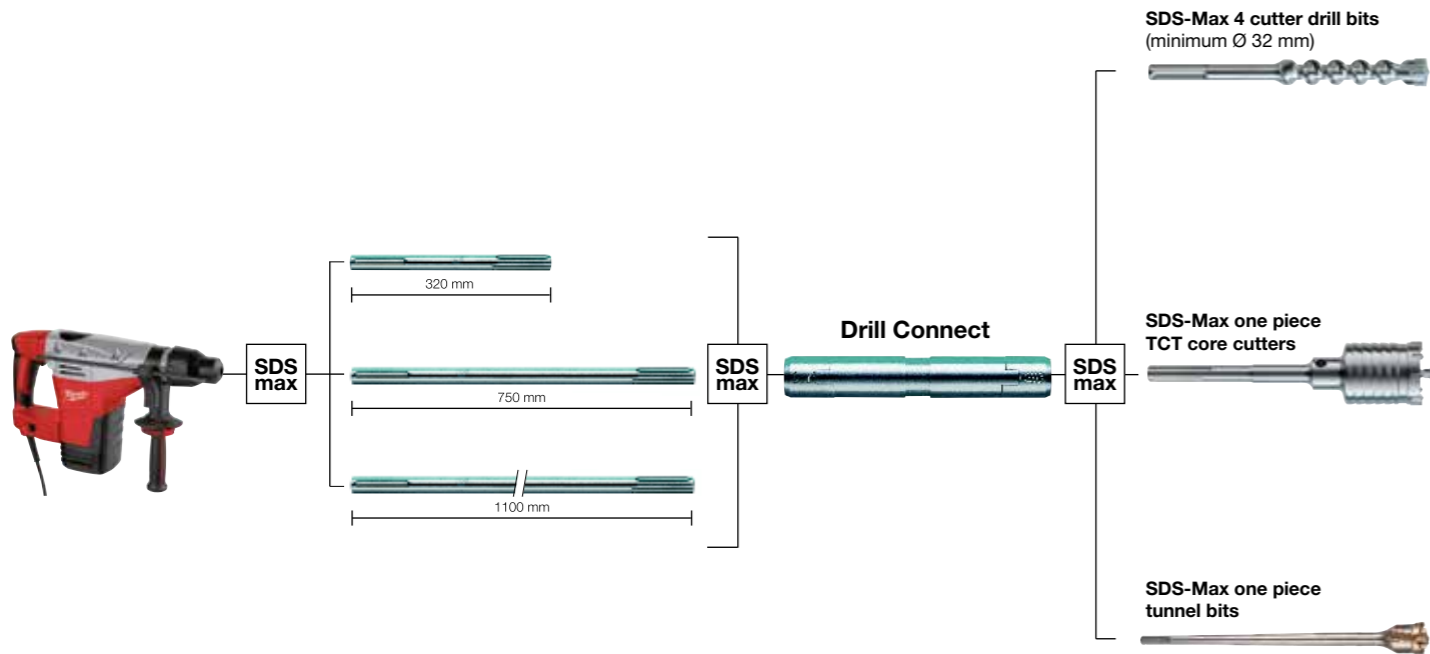

Drill connect

Suitable for use with drilling tools with a Ø of 32 mm and above.
For use with rotary hammers up to 8 kg in weight.

Description	Tool reception	Drill connect reception	Total length (mm) A	Pack quantity	Min. order quantity	Article Number	EAN Code
Drill connect	SDS-Max	SDS-Max	190	1	1	4932399128	4002395357321

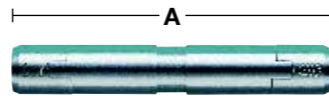

Extension pieces

Description	Tool reception	Drill connect reception	Length (mm) A	Pack quantity	Min. order quantity	Article Number	EAN Code
SDS-Max extension	SDS-Max	SDS-Max	320	1	1	4932399242	4002395358533
SDS-Max extension	SDS-Max	SDS-Max	750	1	1	4932399129	4002395357338
SDS-Max extension	SDS-Max	SDS-Max	1100	1	1	4932399243	4002395358540

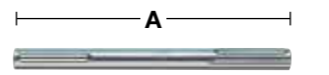

Grease

This grease has been specially formulated to lubricate and protect both the tool and accessories ensuring increased lifetime.
Apply sparingly directly onto the reception of the drill bit, chisel or core cutter, etc.
Contains 50 grams.

Description	Pack quantity	Min. order quantity	Article Number	EAN Code
Grease	1	1	4932352273	4002395369324
Counter display with 15 x single grease tube	15	1	4932352274	4002395369331



SLEDGE™ CHISELS

3X MORE LIFE

*VS STANDARD CHISELS

Our SLEDGE™ Chisels stay sharper for longer. Reinforced edges deliver maximum durability and reduced wear over the life of the chisel. We've engineered these chisels to maintain sharper edges for increased productivity with an optimized tip for fast removal of concrete, rust, cutting troughs, and asphalt.

No re-sharpening or re-hardening necessary for reduced downtime. High grade forged steel for maximum durability and longer life in concrete demolition over our standard scraping chisels. For use with SDS-Plus & Max rotary hammers.

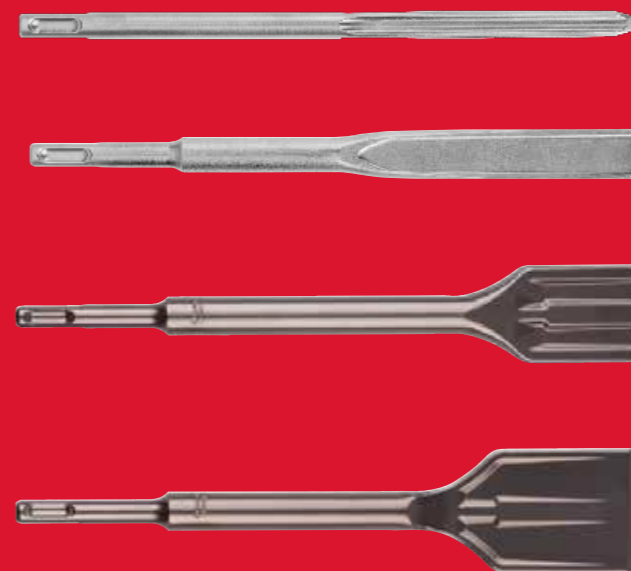

EXTRA LONG
WORKING LENGTH

SELF-SHARPENING TIP

MADE IN
GERMANY

RE-GRINDED TIP
STAYS SHARPER, BEST PERFORMANCE AND AVOIDS JAMMING

Scan the QR Code to see our full video.



SDS-Plus SLEDGE™ Chisels

Up to 3x longer life compared to standard chisels.
Self-sharpening tip geometry for increased productivity.
Reinforced edges for maximum durability.
Made in Germany.

Description	Total length (mm)	Blade width (mm)	Pack quantity	Min. order quantity	Article Number	EAN Code
① SDS-Plus SLEDGE™ pointed chisel	250	-	10	1	4932493607	4058546484781
② SDS-Plus SLEDGE™ flat chisel	250	20	10	1	4932493609	4058546484804
③ SDS-Plus SLEDGE™ wide chisel	250	40	1	1	4932478264	4058546344412
④ SDS-Plus SLEDGE™ tile chisel	250	50	1	1	4932478265	4058546344429



SDS-Max SLEDGE™ self sharpening chisels

Up to 2x longer life compared to standard chisels.
Self sharpening tip geometry.
Extra long working length for more material removal.
Re-ground tip stays sharper for longer and avoids jamming.
Made in Germany.

Description	Total length (mm)	Blade width (mm)	Pack quantity	Min. order quantity	Article Number	EAN Code
① SDS-Max SLEDGE™ pointed chisel	400	-	20	1	4932478266	4058546344436
② SDS-Max SLEDGE™ flat chisel	400	25	20	1	4932478267	4058546344443
③ SDS-Max SLEDGE™ 2 wide chisel	380	50	1	1	4932478268	4058546344450
④ SDS-Max SLEDGE™ 3 wide chisel	300	80	1	1	4932478269	4058546344467
⑤ SDS-Max SLEDGE™ tile chisel	380	50	1	1	4932478270	4058546344474
⑥ SDS-Max SLEDGE™ tile chisel	300	50	1	1	4932478271	4058546344481
⑦ SDS-Max floor scraping tool	635	152	1	1	4932480474	4058546407599
SDS-Max floor scraping service set (10pc) 1 x blade 152x180x1.5 mm, 1 x clamping blade, 4 x nuts, 4 x countersunk bolts			10	1	4932480475	4058546407605

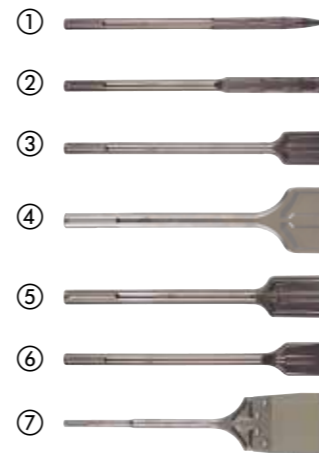

SDS-Plus chisels

Description	Total length (mm)	Blade width (mm)	Pack quantity	Min. order quantity	Article Number	EAN Code
① SDS-Plus thin pointed chisel	180	-	1	1	4932451731	4002395276813
② SDS-Plus pointed chisel	250	-	1	1	4932339625	4002395304813
③ SDS-Plus thin flat chisel	180	14	1	1	4932451732	4002395276820
④ SDS-Plus flat chisel	250	20	1	1	4932339626	4002395304820
⑤ SDS-Plus wide chisel	250	40	1	1	4932367146	4002395334377
⑥ SDS-Plus 3 pc chisel set: 1 x Pointed chisel, 1 x Flat chisel, 1 x Wide chisel	250	-	3	1	4932430001	4002395376629
⑦ SDS-Plus tile removal chisel	250	40	1	1	4932353424	4002395320202
⑧ SDS-Plus gouge chisel	250	22	1	1	4932339627	4002395304837
⑨ SDS-Plus plaster removal chisel	165	75	1	1	4932352344	4002395370030
⑩ SDS-Plus floor / wall scraper	250	100	1	1	4932352919	4002395375776
Spare 1 mm thick floor / wall scraper blade with 3 x bolts / nuts	-	-	1	1	4932480543	4058546408282
⑪ SDS-Plus mortar chisel	125	32	1	1	4932472029	4058546324254
	200	32	1	1	4932472030	4058546324261
⑫ SDS-Plus wing chisel	250	22	1	1	4932479900	4058546376949

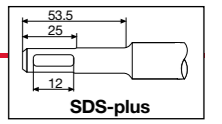
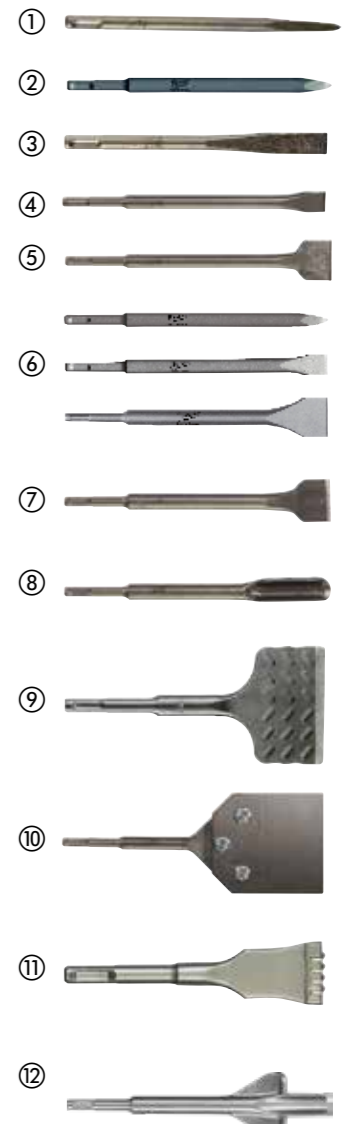

SDS-Max chisels

Description	Total length (mm)	Blade width (mm)	Pack quantity	Min. order quantity	Article Number	EAN Code
① SDS-Max pointed chisel	280	-	1	1	4932343734	4002395317509
	400	-	1	1	4932343735	4002395317516
	400	-	20	1	4932399302	4002395359165
	600	-	1	1	4932343736	4002395317523
② SDS-Max flat chisel	280	25	1	1	4932343737	4002395317530
	400	25	1	1	4932343738	4002395317547
	400	25	20	1	4932399303	4002395359172
	600	25	1	1	4932343739	4002395317554
③ SDS-Max wide chisel	400	50	1	1	4932343743	4002395317592
	300	80	1	1	4932343744	4002395317608
④ SDS-Max tile removal chisel	350	115	1	1	4932343745	4002395317615
	300	80	1	1	4932399234	4002395358489
⑤ SDS-Max chasing gouge chisel	300	26	1	1	4932343740	4002395317561
⑥ SDS-Max chasing wing chisel	380	35	1	1	4932343746	4002395317622
⑦ SDS-Max spade chisel	400	110	1	1	4932343747	4002395317639
⑧ SDS-Max surface treatment / bushing tool	240	45	1	1	4932352918	4002395375769
	220	∅ 13.3	1	1	4932451354	4002395159031
⑨ SDS-Max electrode / ground rod driver	220	∅ 16.6	1	1	4932451355	4002395159048
	220	∅ 22.2	1	1	4932451356	4002395159055
⑩ SDS-Max mortar chisel	280	38	1	1	4932472031	4058546324278

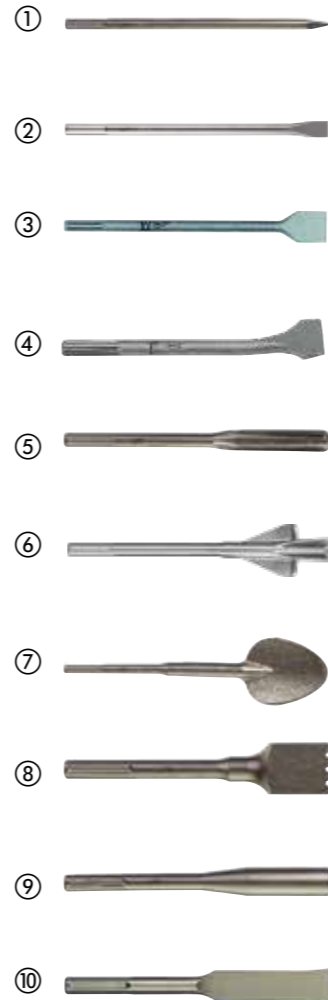
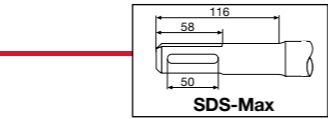

Universal taper shanks

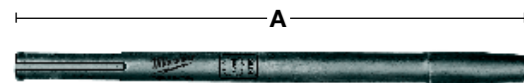

Description	Total length (mm) A	Pack quantity	Min. order quantity	Article Number	EAN Code
Universal taper shank SDS-Max	300	1	1	4932343771*	4002395317745

21 mm Hex chisels

Description	Total length (mm)	Blade width (mm)	Pack quantity	Min. order quantity	Article Number	EAN Code
① 21 mm Hex pointed chisel	380	-	1	1	4932479212	4058546370060
	460	-	1	1	4932492776	4058546476472
② 21 mm Hex flat chisel	600	-	1	1	4932479213	4058546370077
	380	24	1	1	4932479214	4058546370084
③ 21 mm Hex flat wide chisel	460	25	1	1	4932492777	4058546476489
	600	24	1	1	4932479215	4058546370091
④ 21 mm Hex spade chisel	300	50	1	1	4932479216	4058546370107
	300	75	1	1	4932479217	4058546370114
⑤ 21 mm Hex toolholder	450	100	1	1	4932479218	4058546370121
⑥ 21 mm Hex tamping plate	300	-	1	1	4932479219	4058546370138
⑦ 21 mm Hex ground rod driver	120	120	1	1	4932479220	4058546370145

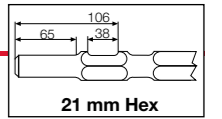

28 mm Hex chisels

Description	Total length (mm)	Blade width (mm)	Pack quantity	Min. order quantity	Article Number	EAN Code
① 28 mm Hex pointed chisel	400	-	1	1	4932459774	4058546029463
② 28 mm Hex flat chisel	400	35	1	1	4932459775	4058546029470
③ 28 mm Hex flat wide chisel	400	80	1	1	4932459776	4058546029487
④ 28 mm Hex spade chisel	400	125	1	1	4932479221	4058546370152
⑤ 28 mm Hex asphalt cutter	440	115	1	1	4932479222	4058546370169
⑥ 28 mm Hex toolholder	390	-	1	1	4932479223	4058546370176
⑦ 28 mm Hex tamping plate	200	200	1	1	4932479224	4058546370183
⑧ 28 mm Hex ground rod driver	300	23	1	1	4932499023	4058546528928

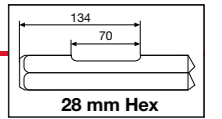

30 mm Hex chisels

Description	Total length (mm)	Blade width (mm)	Pack quantity	Min. order quantity	Article Number	EAN Code
① 30 mm Hex pointed chisel	400	-	1	1	4932464162	4058546221072
② 30 mm Hex flat chisel	400	32	1	1	4932464163	4058546221089
③ 30 mm Hex flat wide chisel	400	75	1	1	4932479225	4058546370190
④ 30 mm Hex spade chisel	400	125	1	1	4932479244	4058546370381
⑤ 30 mm Hex asphalt cutter	400	115	1	1	4932479245	4058546370398
⑥ 30 mm Hex toolholder	360	-	1	1	4932479226	4058546370206

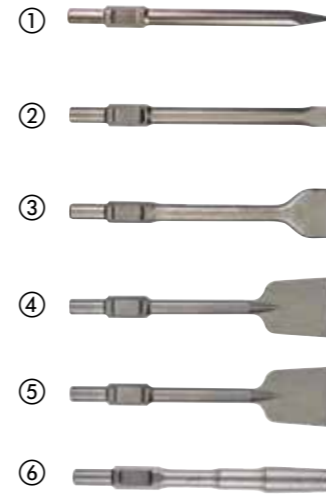
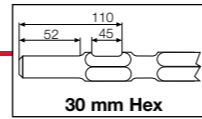

Name		Top view	Suitable for
① SDS-plus	drill		AEG, MILWAUKEE®, Bosch, Dewalt, Hilti, Hitachi, Kango, Makita, Ryobi
① SDS-plus	chisel		AEG, MILWAUKEE®, Bosch, Dewalt, Hilti, Hitachi, Kango, Makita, Ryobi
② SDS-Max	drill		AEG, MILWAUKEE®, Bosch, Dewalt, Hilti, Hitachi, Kango, Makita, Ryobi
② SDS-Max	chisel		AEG, MILWAUKEE®, Bosch, Dewalt, Hilti, Hitachi, Kango, Makita, Ryobi
③ 21 mm Hexagon	drill		Hitachi, Kango, Makita, MILWAUKEE®
④ 21 mm Hexagon	chisel		Hitachi, Kango, Makita, MILWAUKEE®
⑤ 28 mm Hexagon	chisel		AEG, MILWAUKEE®
⑥ 30 mm Hexagon	chisel		Atlas Copco, Kango, MILWAUKEE®

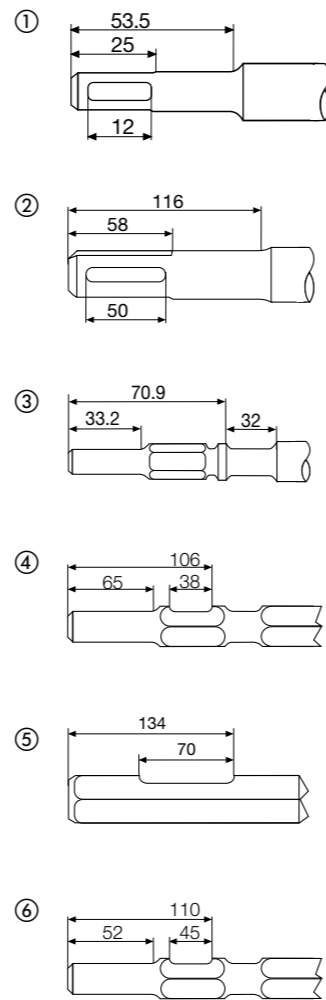

HEX SHANK

- To use with an impact driver and all types of 3 jaw chucks tool like a (percussion) drill driver
- Ensures a safe grip also in standard 3 jaw chucks

WHITE FLUTE

- To identify the drill bit easily in the users toolbox
- First to market with a white flute

2 CUTTER CARBIDE TIP

- Allows drilling into concrete, bricks, roof tiles, cinderblocks, thin metal, ceramic, tiles, wood, PVC, aluminium, drywall, mortar and plywood
- Very popular drill bits for plumbers because of the versatility

MULTI MATERIAL DRILL BITS

Our Multi-Material Drill Bits are the most versatile bits, designed to tackle materials such as brick, block, concrete, steel, aluminium, ceramic tile, wood, PVC, and drywall. The aggressive multi-grind carbide tip delivers up to 10x longer life in stacked materials and up to 85% faster drilling speeds in metal. Equipped with a 1/4" hex shank, these general-purpose bits are compatible with impact drivers.



SHOCKWAVE

IMPACT DUTY

Multi material drill bits

Impact rated: Designed for use with impact drivers and all types of 3 jaw chuck tools like rotary drill/ drivers and percussion drills.

Hex shank up to 260mm total length, 3 flat shank on 400mm total length drill bits.

Tungsten carbide tipped (TCT) drill bits allow drilling into concrete, bricks, roof tiles, aerated concrete blocks, thin metal, aluminium, soft to medium hardness ceramic tiles, all wood types and PVC.

White flute to identify the drill bit easily in the users tool box.

Diameter (mm)	Total length (mm)	Working length (mm)	Pack quantity	Min. order quantity	Article Number	EAN Code
3	90	45	1	1	4932471091	4058546287191
4	90	45	1	1	4932471092	4058546287207
5	100	50	1	1	4932471093	4058546287214
5	150	87	1	1	4932493873	4058546510336
5.5	100	50	1	1	4932471094	4058546287221
5.5	150	90	1	1	4932471095	4058546287238
6	100	50	1	1	4932471096	4058546287245
6	150	90	1	1	4932471097	4058546287252
6	200	140	1	1	4932471098	4058546287269
6	400	340	1	1	4932471099	4058546287276
6.5	108	45	1	1	4932493874	4058546510343
6.5	150	100	1	1	4932471100	4058546287283
6.5	200	140	1	1	4932471101	4058546287290
6.5	400	340	1	1	4932471102	4058546287306
7	100	50	1	1	4932471103	4058546287313
7	150	87	1	1	4932493875	4058546510350
8	120	60	1	1	4932471104	4058546287320
8	260	200	1	1	4932471105	4058546287337
8	400	340	1	1	4932471106	4058546287344
10	120	60	1	1	4932471107	4058546287351
10	260	200	1	1	4932471108	4058546287368
10	400	340	1	1	4932471109	4058546287375
12	150	90	1	1	4932471110	4058546287382
12	260	200	1	1	4932471111	4058546287399
12	400	340	1	1	4932493876	4058546510367
14	260	200	1	1	4932493877	4058546510374
14	400	340	1	1	4932493878	4058546510381
16	260	200	1	1	4932493879	4058546510398
16	400	340	1	1	4932493880	4058546510404

Multi material drill bit set (8pc)						
Ø 4 x 100 mm, Ø 5 / 5 / 6 / 6 x 108 mm, Ø 8 / 10 x 120 mm, Ø 12 x 150 mm			8	1	4932493871	4058546510312

Multi material drill bit set (8pc)						
Ø 4 x 100 mm, Ø 5 / 5.5 / 5.5 x 108mm, Ø 6 / 7 x 108mm, Ø 8 / 10 x 120mm			8	1	4932493872	4058546510329

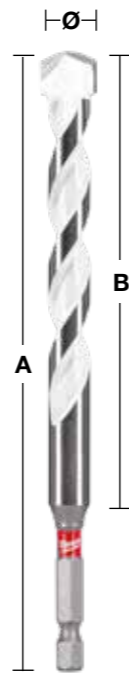

DESIGNED FOR USE IN
PACKOUT



Premium concrete drill bits - 3 flat shank

Tungsten carbide tipped (TCT) drill bits allow drilling into concrete, aerated concrete blocks, masonry, slate and granite. From Ø 5 mm the hammer drill bits are supplied with a 3 flat shank to prevent the drill bit slipping in the chuck. Ø 3 & 4 mm the drill bits are supplied with a round shank. Red flute to identify the drill bit easily in the users tool box. Can be used in hammer and rotary mode.

Diameter (mm)	Total length (mm)	Working length (mm)	Pack quantity	Min. order quantity	Article Number	EAN Code
3	90	45	1	1	4932471167	4058546287955
3.5	90	45	1	1	4932493883	4058546510435
4	90	45	1	1	4932471169	4058546287979
5	100	50	1	1	4932471171	4058546287993
5	150	90	1	1	4932493884	4058546510442
5.5	100	50	1	1	4932471173	4058546288013
5.5	150	90	1	1	4932493885	4058546510459
6	100	50	1	1	4932471175	4058546288037
6	150	90	1	1	4932471176	4058546288044
6	260	200	1	1	4932493886	4058546510466
6.5	100	50	1	1	4932471178	4058546288068
6.5	150	90	1	1	4932471179	4058546288075
7	100	50	1	1	4932471180	4058546288082
7	150	90	1	1	4932471181	4058546288099
8	100	50	1	1	4932471182	4058546288105
8	150	90	1	1	4932471183	4058546288112
8	200	140	1	1	4932493887	4058546510473
8	400	340	1	1	4932493888	4058546510480
9	120	60	1	1	4932493889	4058546510497
10	150	90	1	1	4932471186	4058546288143
10	260	200	1	1	4932471187	4058546288150
10	400	340	1	1	4932493890	4058546510503
11	150	90	1	1	4932493891	4058546510510
12	150	90	1	1	4932471188	4058546288167
12	260	200	1	1	4932471189	4058546288174
12	400	340	1	1	4932493892	4058546510527
14	150	90	1	1	4932471190	4058546288181
14	260	200	1	1	4932471191	4058546288198
16	150	90	1	1	4932493893	4058546510534
25	300	250	1	1	4932501245	4058546639617

Premium concrete drill bit set (8pc)						
①	Ø 4 x 90 mm, Ø 5 / 5.5 / 5.5 / 6 / 7 x 100 mm, Ø 8 / 10 x 150 mm		8	1	4932493881	4058546510411
Premium concrete drill bit set (8pc)						
②	Ø 4 x 90 mm, Ø 5 / 5 / 6 / 6 x 100 mm, Ø 8 / 10 / 12 x 150 mm		8	1	4932493882	4058546510428

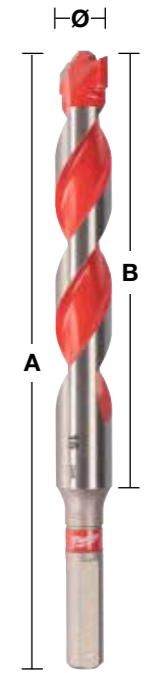

DESIGNED FOR USE IN
PACKOUT



Glass & tile bits

Suitable for drilling in non toughened glass, soft to medium hardness tiles and ceramics. Sharpened carbide for faster drilling. Reinforced carbide head for increased durability. Red painted tip. From Ø 5 mm the glass & tile drill bits are supplied with a multi-flat shank to prevent the drill bit slipping in the chuck.

Diameter (mm)	Pack quantity	Min. order quantity	Article Number	EAN Code
3	1	1	4932471955	4058546298548
4	1	1	4932471956	4058546298555
5	1	1	4932471957	4058546298562
5.5	1	1	4932471855	4058546297541
6	1	1	4932471958	4058546298579
6.5	1	1	4932471856	4058546297558
7	1	1	4932471857	4058546297565
8	1	1	4932471959	4058546298586
10	1	1	4932471960	4058546298593
12	1	1	4932471961	4058546298609
14	1	1	4932471858	4058546297572
16	1	1	4932471859	4058546297589

Glass & Tile Drill Set - 5pc						
	Ø 4 / 5 / 2 x 6 / 8		5	12	4932479948	4058546377427



Impact rated wood auger bits

Suitable for use with all types of corded / cordless drills including impact wrenches.
 Drilling with an impact wrench enables drilling holes with less effort, one hand drilling, drilling up a ladder and above head height with less risk of injury from the tool clutching out.
 Special zone hardening process ensures an extra hard shank, durable tip and perfectly flexible bit body.
 New MILWAUKEE® Through-Center head geometry with the lead cutting edge lines up with the center of the feed screw - this ensures efficient chip removal and allows for continuous feeding.
 20° rake angle of the lead cutting edge creates a path for easy chip ejection.
 Polished and powder coated flute design produces a non-stick surface for increased chip ejection, reduced chip clogging and higher selffeeding capability.
 Milling marks are removed in the finishing process, creating a smooth surface.
 Lewis flute with large, wide throat design for rapid chip removal.
 Sharp ground cutting lips for smooth clean holes.
 Resharpenable cutting lips.
 With 7/16" shank - to fit square drive 1/2" impact wrenches the adaptor 48660061 is required.
 Suitable for hard & soft wood, wet & treated wood, plywood, chipboard, WPC (wood plastic composite), laminated beams and panels, exotic and hard woods e.g. bongossi, iroko, teak, beech, oak, etc.



Impact wood auger bits - long series

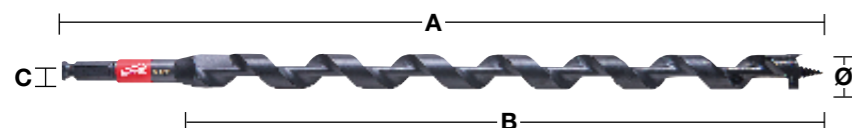

Diameter (mm)	Total length (mm) A	Working length (mm) B	Shank reception	Pack quantity	Min. order quantity	Article Number	EAN Code
14	460	395	7/16" Hex	1	1	48136754	045242518999
16	460	395	7/16" Hex	1	1	48136756	045242519002
18	460	395	7/16" Hex	1	1	48136758	045242500994
19	460	395	7/16" Hex	1	1	48136759	045242519019
20	460	395	7/16" Hex	1	1	48136760	045242501007
22	460	395	7/16" Hex	1	1	48136762	045242519033
26	460	395	7/16" Hex	1	1	48136766	045242501014
29	460	395	7/16" Hex	1	1	48136769	045242519057
Impact wood auger bit set (4pc) available in a pouch Ø 14 / 16 / 18 / 20 x 460 mm				4	1	48136780	045242005383

Impact wood auger and selffeed bits - adaptor

Description	Pack quantity	Min. order quantity	Article Number	EAN Code
Socket adaptor: 1/2" square to 7/16" and 11 mm Hex. For 7/16" selffeed bits and impact auger bits	1	1	48660061	045242155118



WOOD DRILLING SPEEDS

The following table give recommended drilling speeds for the most efficient cutting speed. The table should only be used as a guide and are dependant on the user and material being drilled.



Forstner bits / Selffeed bits

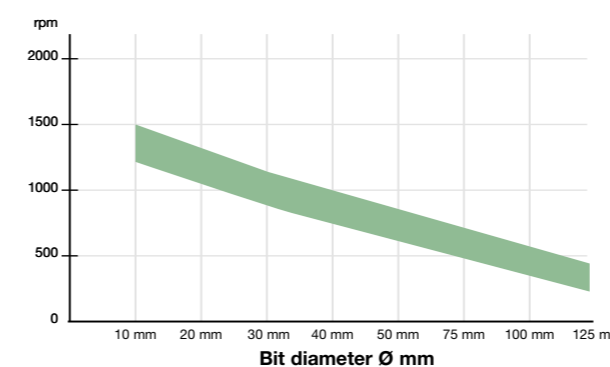

Auger bits

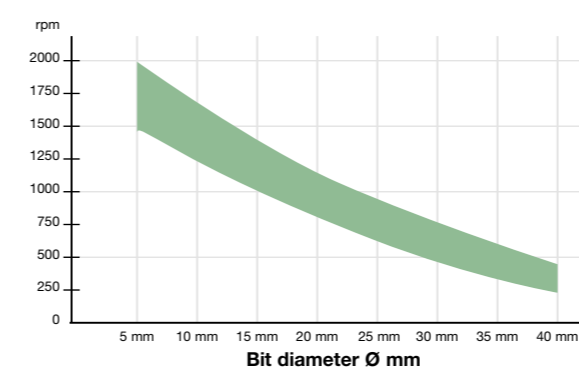

Wood auger bits

For heavy duty, precision drilling in soft and hard wood, large section beams, joists, floor boarding, chipboard and plywood.
Lewis flute design for rapid chip removal.
With Hex shank for secure chuck grip.

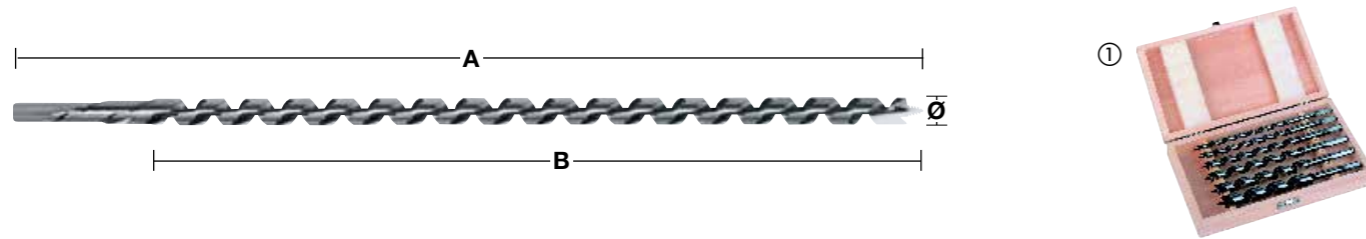

Diameter (mm)	Total length (mm) A	Working length (mm) B	Shank reception	Pack quantity	Min. order quantity	Article Number	EAN Code
6	230	155	6.5 mm Hex	1	1	4932430175	4002395378364
6	460	385	6.5 mm Hex	1	1	4932430176	4002395378371
8	230	155	6.5 mm Hex	1	1	4932363681	4002395331796
8	460	385	6.5 mm Hex	1	1	4932363688	4002395331710
10	230	155	8.5 mm Hex	1	1	4932363682	4002395331802
10	460	385	8.5 mm Hex	1	1	4932363689	4002395331727
10	600	530	8.5 mm Hex	1	1	4932363696	4002395331642
12	230	155	10 mm Hex	1	1	4932363683	4002395331819
12	460	385	10 mm Hex	1	1	4932363690	4002395331734
12	600	530	10 mm Hex	1	1	4932363697	4002395331659
14	230	155	11 mm Hex	1	1	4932363684	4002395331826
14	460	385	11 mm Hex	1	1	4932363691	4002395331741
14	600	530	11 mm Hex	1	1	4932363698	4002395331666
16	230	155	11 mm Hex	1	1	4932363685	4002395331833
16	460	385	11 mm Hex	1	1	4932363692	4002395331758
16	600	530	11 mm Hex	1	1	4932363699	4002395331673
18	230	155	11 mm Hex	1	1	4932363686	4002395331840
18	460	385	11 mm Hex	1	1	4932363693	4002395331765
18	600	530	11 mm Hex	1	1	4932363700	4002395331680
20	230	155	11 mm Hex	1	1	4932363687	4002395331857
20	460	385	11 mm Hex	1	1	4932363694	4002395331772
20	600	530	11 mm Hex	1	1	4932363701	4002395331697
22	230	155	11 mm Hex	1	1	4932373363	4002395347889
22	460	385	11 mm Hex	1	1	4932363695	4002395331789
22	600	530	11 mm Hex	1	1	4932363702	4002395331703
24	230	155	11 mm Hex	1	1	4932373364	4002395347896
24	460	385	11 mm Hex	1	1	4932373370	4002395348558
26	230	155	11 mm Hex	1	1	4932373365	4002395348503
26	460	385	11 mm Hex	1	1	4932373371	4002395348565
28	230	155	11 mm Hex	1	1	4932373366	4002395348510
28	460	385	11 mm Hex	1	1	4932373372	4002395348572
30	230	155	11 mm Hex	1	1	4932373367	4002395348527
30	460	385	11 mm Hex	1	1	4932373373	4002395348589
32	230	155	11 mm Hex	1	1	4932373368	4002395348534
32	460	385	11 mm Hex	1	1	4932373374	4002395348596
Wood auger bits set (6pc)			Wood case	6	1	4932373380	4002395349258
① Ø 8 / 10 / 12 / 14 / 16 / 18 mm x 230 mm							

Forstner bits

Centre point for precisely locating the bit. Peripheral cutters ensure splinter free drilling in all natural soft and hard woods.
Manufactured according to DIN 74836. Suitable for heavy-duty applications in all natural, soft and hard woods.



Diameter (mm)	Total length (mm) A	Working length (mm) B	Shank reception	Pack quantity	Min. order quantity	Article Number	EAN Code
10	90	50	9.5 mm round shank	1	1	4932363703	4002395331468
12	90	50	9.5 mm round shank	1	1	4932363704	4002395331475
14	90	50	9.5 mm round shank	1	1	4932363705	4002395331482
15	90	50	9.5 mm round shank	1	1	4932363883	4002395333738
16	90	50	9.5 mm round shank	1	1	4932363706	4002395331499
18	90	50	9.5 mm round shank	1	1	4932363707	4002395331505
20	90	50	9.5 mm round shank	1	1	4932363708	4002395331512
25	90	50	9.5 mm round shank	1	1	4932363711	4002395331543
26	90	50	9.5 mm round shank	1	1	4932363712	4002395331550
30	90	50	9.5 mm round shank	1	1	4932363714	4002395331574
32	90	50	9.5 mm round shank	1	1	4932363715	4002395331581
35	90	50	9.5 mm round shank	1	1	4932363717	4002395331604
40	90	50	9.5 mm round shank	1	1	4932363720	4002395331635
50	90	50	9.5 mm round shank	1	1	4932373923	4002395353538
Forstner drill bits set (5pc)				5	1	4932373379	4002395349241
① Ø 15 / 20 / 25 / 30 / 35 mm							

SHOCKWAVE IMPACT DUTY



SHOCKWAVE IMPACT DUTY



SWITCHBLADE™ selffeed bits

Speed: Aggressive feed screw design allows the bit to pull through the wood faster and without effort, resulting in faster drilling.

Replaceable SWITCHBLADE™: The SWITCHBLADE™ replaceable blade system ensures your blade is always razor sharp. It increases productivity by eliminating resharpening downtime and it increases the overall life of the bit.

Application: Suitable for all general contractors, electricians, plumbers and HVAC engineers who require to drill through holes in wood for all types of pipe, vents and wire trunking.

Each selffeed bit is supplied with 1x blade, 2x replaceable feed screws, 1x set screws and 1x allen key.



Diameter (mm)	Shank reception	Pack quantity	Min. order quantity	Article Number	EAN Code
35	7/16" Hex	1	1	4932479497	4058546372910
38	7/16" Hex	1	1	4932479498	4058546372927
51	7/16" Hex	1	1	4932479499	4058546372934
54	7/16" Hex	1	1	4932479500	4058546372941
57	7/16" Hex	1	1	4932479501	4058546372958
65	7/16" Hex	1	1	4932479502	4058546372965

SWITCHBLADE™ set

Description	Pack quantity	Min. order quantity	Article Number	EAN Code
SWITCHBLADE™ selffeed bits set (5pc) 4 x SWITCHBLADE™ selffeed bits: Ø 35 / 38 / 54 / 65 mm, QUIK-LOK extension 140 mm length, 4 x Replacement SWITCHBLADE™ blades (1 for each size bit), 4 x feed screws, 4 x set screws, 1 x allen key	5	1	4932479503	4058546372972



SWITCHBLADE™ replacement blades

Diameter (mm)	Pack quantity	Min. order quantity	Article Number	EAN Code
35	1	1	4932479546	4058546373405
38	1	1	4932479547	4058546373412
51	1	1	4932479548	4058546373429
54	1	1	4932479549	4058546373436
57	1	1	4932479550	4058546373443
65	1	1	4932479551	4058546373450



Description	Pack quantity	Min. order quantity	Article Number	EAN Code
SWITCHBLADE™ service kit in storage container 1x feed screw, 2x set screws, 1x allen key, 1x storage container also can store spare SWITCHBLADE™	5	1	4932479552	4058546373467

Selffeed bits

All sizes have removable and replaceable feed screws.

Two feed screws supplied with each bit.

Feed screw provides fast, effortless feeding even in gummy woods.

Internal cutting plane shaves hole radius for clean, smooth holes without pressure.

Each selffeed bit is supplied with 2 x feed screws, 1 x set screw and 1 x allen key.

Diameter (mm)	Shank reception	Pack quantity	Min. order quantity	Article Number	EAN Code
25	7/16" Hex	1	1	4932479478	4058546372729
29	7/16" Hex	1	1	4932479479	4058546372736
32	7/16" Hex	1	1	4932479480	4058546372743
35	7/16" Hex	1	1	4932479481	4058546372750
38	7/16" Hex	1	1	4932479482	4058546372767
44	7/16" Hex	1	1	4932479483	4058546372774
51	7/16" Hex	1	1	4932479484	4058546372781
54	7/16" Hex	1	1	4932479485	4058546372798
57	7/16" Hex	1	1	4932479486	4058546372804
65	7/16" Hex	1	1	4932479487	4058546372811
Feed screw coarse thread 1/4"		1	1	48286870	045242122707
Hex key 1/8" for all arbors		1	1	43960270	045242825134
Set screw for drills up to 65 mm		1	1	06832625	-



Large selffeed bits

Large selffeed bits in 76, 92 and 116 mm sizes have double internal cutter blades that shave hole radius for clean, smooth holes without pressure.

Replaceable arbor.

Diameter (mm)	Shank reception	Pack quantity	Min. order quantity	Article Number	EAN Code
76	7/16" Hex	1	1	4932479489	4058546372835
92	7/16" Hex	1	1	4932479490	4058546372842
116	7/16" Hex	1	1	4932479491	4058546372859
Replaceable arbor		1	1	48070201	045242088904
Feed screw regular thread		1	1	48286880	045242122806
Set screw for drills up over 76mm		1	1	06833150	4058546040864
Allen key 5/32"		1	1	49960070	045242221554



Selffeed bits contractors kit

Description	Pack quantity	Min. order quantity	Article Number	EAN Code
Selffeed bit contractors kit (8pc) Selffeed bits Ø 25 / 29 / 32 / 38 / 44 / 54 / 65 mm, extension 140 mm length and feed screws	8	1	4932479488	4058546372828



Shank extensions

For selffeed bits, auger bits and holesaws (25 mm / 1" diameter and larger) with 7/16" Hex shank

Total length (mm) A	Pack quantity	Min. order quantity	Article Number	EAN Code
140	1	1	4932479493	4058546372873
300	1	1	4932479494	4058546372880
450	1	1	4932479495	4058546372897
600	1	1	4932479496	4058546372903

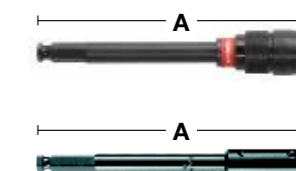

Lip & spur / brad point bits for wood - DIN 7487 E

Suitable for drilling hardboard, plywood, chipboard and all natural hard and soft wood.
Produced according to DIN 7487 E.

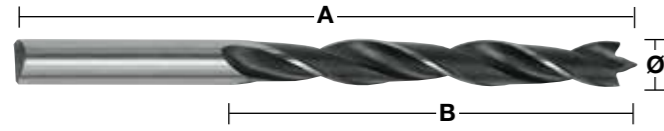

Diameter (mm)	Total length (mm) A	Working length (mm) B	Shank reception	Pack quantity	Min. order quantity	Article Number	EAN Code
3	61	33	3 mm round shank	1	1	4932363651	4002395331307
4	75	43	4 mm round shank	1	1	4932363652	4002395331314
5	86	52	5 mm round shank	1	1	4932363653	4002395331321
6	93	57	6 mm round shank	1	1	4932363654	4002395331338
7	109	69	7 mm round shank	1	1	4932363655	4002395331345
8	117	75	8 mm round shank	1	1	4932363656	4002395331352
9	125	80	9 mm round shank	1	1	4932363657	4002395331369
10	133	87	10 mm round shank	1	1	4932363658	4002395331376
11	142	89	10 mm round shank	1	1	4932363659	4002395331383
12	151	96	10 mm round shank	1	1	4932363660	4002395331390
13	151	96	10 mm round shank	1	1	4932363661	4002395331406
14	151	97	10 mm round shank	1	1	4932363662	4002395331413
15	151	97	10 mm round shank	1	1	4932363663	4002395331420
16	151	97	10 mm round shank	1	1	4932363664	4002395331437
18	180	120	10 mm round shank	1	1	4932363665	4002395331444
20	200	130	10 mm round shank	1	1	4932363666	4002395331451
① Wood drill bit set (5pc) Ø 4 / 5 / 6 / 8 / 10 mm			Plastic cassette	5	1	4932352465	4002395371242
② Wood drill bit set (8pc) Ø 3 / 4 / 5 / 6 / 7 / 8 / 9 / 10 mm			Plastic cassette	8	1	4932352466	4002395371259

Flat boring bits

Fast drilling of big diameters.
Suitable for drilling in natural hard and softwood and chipboard.
Ideal for door locks, morticing, electrical and plumbing work.
1/4" Hex shank reception (DIN E 6.3) for direct insertion into the power tool or for secure chuck grip.
Ground centre point for accurate positioning and sharp wings (not applicable to 6 & 8 mm) for improved cutting performance.

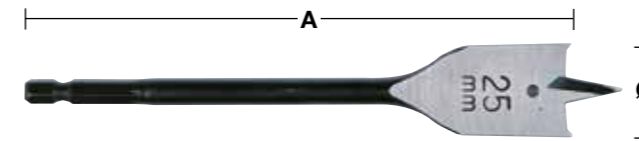

Diameter (mm)	Total length (mm) A	Pack quantity	Min. order quantity	Article Number	EAN Code
6	152	1	1	4932352487	4002395371457
6	400	1	1	4932352488	4002395371464
8	152	1	1	4932363130	4002395332618
8	400	1	1	4932352489	4002395371471
10	152	1	1	4932363131	4002395332625
10	400	1	1	4932352490	4002395371488
12	152	1	1	4932363132	4002395332632
12	400	1	1	4932352491	4002395371495
13	152	1	1	4932363133	4002395332649
13	400	1	1	4932352492	4002395371501
14	152	1	1	4932363134	4002395332656
14	400	1	1	4932352493	4002395371518
16	152	1	1	4932363135	4002395332663
16	400	1	1	4932352494	4002395371525
18	152	1	1	4932363136	4002395332670
18	400	1	1	4932352495	4002395371532
19	152	1	1	4932363137	4002395332687
19	400	1	1	4932352496	4002395371549
20	152	1	1	4932363138	4002395332694
20	400	1	1	4932352497	4002395371556
22	152	1	1	4932363139	4002395332700
22	400	1	1	4932352498	4002395371563
24	152	1	1	4932363140	4002395332717
25	152	1	1	4932363141	4002395332724
25	400	1	1	4932352499	4002395371570
26	152	1	1	4932363142	4002395332731
28	152	1	1	4932363143	4002395332748
28	400	1	1	4932352500	4002395371587
30	152	1	1	4932363144	4002395332755
30	400	1	1	4932352501	4002395371594
32	152	1	1	4932363145	4002395332762
32	400	1	1	4932352502	4002395371600
35	400	1	1	4932352503	4002395371617
36	152	1	1	4932363146	4002395332779
38	152	1	1	4932363147	4002395332786
40	152	1	1	4932479227	4058546370213
① Flat bit set (8pc) Ø 12 / 16 / 18 / 20 / 22 / 25 / 28 / 32 x 152 mm length		8	1	4932352504	4002395371624

Extension

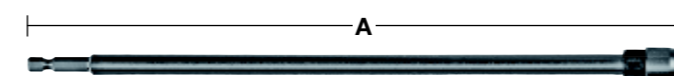

Description	Total length (mm) A	Shank reception	Tool reception	Pack quantity	Min. order quantity	Article Number	EAN Code
Extension	305	1/4" Hex	1/4" Hex	1	1	4932363148	4002395332793

SPEED FEED™ wood drill bits

Step up from flat bit in quality and performance - faster drilling, higher lifetime and less jamming!
Dual cutting edges for fast and aggressive cut - up to 10 times faster drilling vs. flat boring bit.
Tapered design for reduced chip clogging, less friction and less jamming even in tough applications - results in less breakages.
Feed screw with coarse thread increases selffeeding in all types of wood - soft & hard, wet & treated.
Polished and powder coated flute design for increased chip ejection, reduced clogging and higher selffeeding capability.



Dual cutting edges



Tapered design

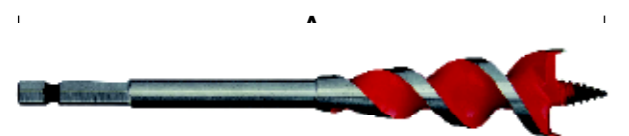

Diameter (mm)	Ø (Inch)	Total length (mm) A	Shank reception	Pack quantity	Min. order quantity	Article Number	EAN Code
13	1/2"	165	1/4" Hex	1	1	4932479471	4058546372651
16	5/8"	165	1/4" Hex	1	1	4932479472	4058546372668
18	3/4"	165	1/4" Hex	1	1	4932464071	4058546220167
20	3/4"	165	1/4" Hex	1	1	4932479473	4058546372675
22	7/8"	165	1/4" Hex	1	1	4932479474	4058546372682
25	1"	165	1/4" Hex	1	1	4932479475	4058546372699
32	1 1/4"	165	1/4" Hex	1	1	4932479476	4058546372705
SPEED FEED™ set (4pc) Ø 13 / 16 / 20 / 25 mm				4	1	4932479477	4058546372712

HSS cable bits - DIN 7490

Manufactured from HSS steel for increased lifetime. Suitable for drilling through holes in wood, plasterboard and metal channel.
Manufactured according to DIN 7490 and conforming to the German Employer's Liability Insurance Association in terms of safety requirements for the building trade. The body of the drill bit is attached to the cylindrical shank by means of a thread, therefore eliminating the risk of breakage and guaranteeing absolute concentricity. The small twist angle and enlarged flutes ensure rapid and clog-free chip removal.
Made in Germany.

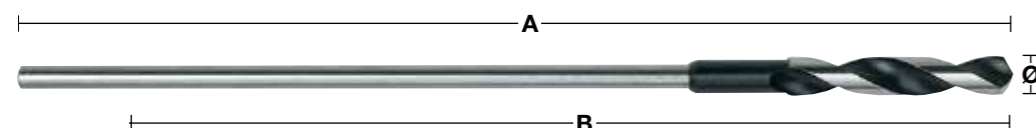

Diameter (mm)	Total length (mm) A	Working length (mm) B	Shank reception	Pack quantity	Min. order quantity	Article Number	EAN Code
6	400	300	5 mm round shank	1	1	4932399672	4002395363223
6	600	500	5 mm round shank	1	1	4932399675	4002395363254
8	400	300	6 mm round shank	1	1	4932363667	4002395331932
8	600	500	6 mm round shank	1	1	4932363674	4002395331864
10	400	300	8 mm round shank	1	1	4932363668	4002395331949
10	600	500	8 mm round shank	1	1	4932363675	4002395331871
12	400	300	8 mm round shank	1	1	4932363669	4002395331956
12	600	500	8 mm round shank	1	1	4932363676	4002395331888
14	400	300	8 mm round shank	1	1	4932363670	4002395331963
14	600	500	8 mm round shank	1	1	4932363677	4002395331895
16	400	300	10 mm round shank	1	1	4932363671	4002395331970
16	600	500	10 mm round shank	1	1	4932363678	4002395331901
18	400	300	10 mm round shank	1	1	4932363672	4002395331987
18	600	500	10 mm round shank	1	1	4932363679	4002395331918
20	400	300	10 mm round shank	1	1	4932363673	4002395331994
20	600	500	10 mm round shank	1	1	4932363680	4002395331925
22	400	300	10 mm round shank	1	1	4932399673	4002395363230
22	600	500	10 mm round shank	1	1	4932399676	4002395363261

HSS Drill bit tip geometry

Standard/Form	Application	Features
	For standard drilling in ferrous/non ferrous metals and plastics	The wide cutting edge provides a drill bit that is robust and resistant to sideways pressure. Due to the wide cutting edge higher feed pressure is required. Can be easily resharpened.
	For drilling work in solid steel with large diameter drill bits.	Good and easy centering. Requires very low feed pressure - approx. 30% less than a normal point drill bit.
	For drilling in high strength steel and high alloy steels. Also suitable for drilling thin sheet material.	Robust and resistant to sideways pressure.
	For drilling in high strength steel and high alloy steels. Suitable for deep drilling bits.	Excellent chip removal makes this design ideal for deep drilling applications. Good centering. Low feed pressure required.
	For drilling cast iron.	Extended major cutting edges reduce wear on the cutting corners for improved lifetime. Good heat conduction. Resistant to sideways pressure.
	For drilling thin sheet metal and soft materials.	Easy centering. Low feed pressure required. Does not snatch when drilling thin materials. Accurate and clean holes.
	For high performance drilling in high strength steels such as stainless and acid resistant steel.	Easy centering. Produces small metal chips ensuring low heat build up and quicker material resulting in faster drilling.
	For drilling in high strength steel and high alloy steel.	Easy centering and fast drilling start with 135° split point tip. Four cutting edges create smaller chips to prevent heat build up for longer life.

HSS Drill bit application guide

The following table gives recommended drilling speeds for the most efficient cutting speed. The tables should only be used as a guide and are dependant on the user and material being drilled. Coolants and lubricants will improve tool life by up to 5 times and workpiece finish.

Material class	Material type	Hardness/ Tensile Strength N/mm ²	Rockwell	Hole diameter Ø mm – RPM					Cooling agent	
				Ø 1-2	Ø 3-5	Ø 6-10	Ø 11-15	Ø 16-20		
Steel	Non-alloyed construction steel, non-alloyed case hardened steel	< 400	< HRB 69	4770	1870	930	630	470	Drilling emulsion, cutting oil	
		400-800	< HRC 21	4450	1770	870	580	430		
	Sheet Steel	< 800	< HRC 21	4450	1760	860	560	430	Drilling emulsion, ester oil	
	Non-alloyed tool steel	< 800	< HRC 21	4440	1760	860	560	430	Drilling emulsion, cutting oil	
		> 800	> HRC 21	3950	1550	780	520	390	Drilling emulsion, ester oil	
Alloyed tool steel	< 1200	< HRC 37	2100	890	450	300	210	Drilling emulsion, ester oil		
Alloyed hardened & tempered steel	> 1200	> HRC 38	1350	540	260	170	120			
Feed	Feed (mm/rev)			0.03	0.09	0.15	0.20	0.25		
Stainless steel	Speed	Stainless steel	< 1000	< HRC 30	2250	930	450	290	220	Rapeseed oil, cutting oil
		Stainless steel	1000-1200	HRC 30-37	1430	560	280	190	130	
	Feed	Feed (mm/rev)			0.02	0.06	0.13	0.18	0.24	
Cast iron	Speed	Malleable cast iron	750	HRB 99	4700	2000	1100	800	600	Dry
		Soft	450	HRB 75	4500	1700	950	650	550	Drilling emulsion, cutting oil
		Hard	700	HRB 96	3450	1350	680	440	340	
	Feed	Feed (mm/rev)			0.05	0.10	0.16	0.20	0.25	
Aluminium	Speed		< 350	< HRC 59	8700	3560	1720	1130	860	Drilling emulsion, cutting oil
	Feed	Feed (mm/rev)			0.02	0.08	0.13	0.18	0.23	
Copper	Speed				5100	2000	990	670	500	Drilling emulsion, cutting oil
	Feed	Feed (mm/rev)			0.02	0.10	0.20	0.28	0.35	
Bronze	Speed				7950	3190	1480	1010	770	Dry
	Feed	Feed (mm/rev)			0.02	0.11	0.21	0.32	0.35	
Brass	Speed				7950	3190	1480	1010	770	Drilling emulsion
	Feed	Feed (mm/rev)			0.02	0.11	0.21	0.32	0.35	
Magnesium	Speed				9550	3800	1900	1250	970	Dry
	Feed	Feed (mm/rev)			0.05	0.10	0.25	0.30	0.35	
Plastics	Speed	PVC, Polyamide, Thermoplastics			3500	2500	1800	700	450	Water
	Feed	Feed (mm/rev)			0.05	0.10	0.16	0.21	0.23	

RPM: The number of revolutions that a spindle/a cutting tool completes in one minute.

Feed: This is the linear distance at which the cutter is advanced against the workpiece during one rotation of the cutting tool. It is expressed in units of distance per revolution – millimetres per revolution.

DRILL BITS FOR METAL

Which HSS drill bit for which material?

BEST PERFORMANCE

GOOD PERFORMANCE



MATERIAL CLASS	MATERIAL TYPE	HARDNESS/ TENSILE STRENGTH N/MM ²	ROCKWELL	HSS-R DIN 338	HSS-G THUNDERBOLT, DIN 338, DIN 340, DIN 1897 DOUBLE ENDED, HSS-G COUNTERSINKS, COMBI DRILL TAP'S	RED COBALT - HSS-GROUND - DIN 338 AND COBALT COUNTERSINKS	RED HEX - SHOCKWAVE HSS- GROUND TITANIUM	STEP DRILLS	SHOCKWAVE STEP DRILLS	COBALT STEP DRILLS	COOLING AGENT
STEEL	NON-ALLOYED CONSTRUCTION STEEL, NON-ALLOYED CASE HARDENED STEEL	< 400	< HRB 69								DRILLING EMULSION, CUTTING OIL
		400-800	< HRC 21								DRILLING EMULSION, CUTTING OIL
	SHEET STEEL	< 800	< HRC 21								DRILLING EMULSION, ESTER OIL
	NON-ALLOYED TOOL STEEL	< 800	< HRC 21								DRILLING EMULSION, CUTTING OIL
	ALLOYED TOOL STEEL	< 800	< HRC 21								DRILLING EMULSION, ESTER OIL
		> 800	> HRC 21								DRILLING EMULSION, ESTER OIL
	ALLOYED HARDENED & TEMPERED STEEL	< 1200	< HRC 37								DRILLING EMULSION, ESTER OIL
		> 1200	> HRC 38								DRILLING EMULSION, ESTER OIL
STAINLESS STEEL	STAINLESS STEEL	< 1000	< HRC 30								RAPESEED OIL, CUTTING OIL
	STAINLESS STEEL	1000-1200	HRC 30-37								RAPESEED OIL, CUTTING OIL
CAST IRON	MALLEABLE CAST IRON	750	HRB 99								DRY
	SOFT	450	HRB 75								DRILLING EMULSION, CUTTING OIL
	HARD	700	HRB 96								DRILLING EMULSION, CUTTING OIL
ALUMINIUM		< 350	< HRC 59							DRILLING EMULSION, CUTTING OIL	
COPPER											DRILLING EMULSION, CUTTING OIL
BRONZE											DRY
BRASS											DRILLING EMULSION
MAGNESIUM											DRY
PLASTICS	PVC, POLYAMIDE, THERMOPLASTICS										WATER
WOOD											DRY

HIGH PERFORMANCE DRILL BITS

RED HEX
SHOCKWAVE
IMPACT DUTY

HSS-TiN METAL
DRILL BITS

RED COBALT
HSS-CO METAL
DRILL BITS



RED HEX & RED COBALT SPECIFICATIONS

QUAD EDGE™ TIP

- Unique combination of 135° split point and four cutting edges.
- Allows for precise and fast drilling start without walking.
- Four cutting edges create smaller chips to prevent heat build up to ensure longer life.

VARIABLE FLUTE GEOMETRY

- Faster material ejection.
- Helps the bit run cooler and prevent it from burning out faster.

ENHANCED TAPERED WEB

- Wider core towards the shank of the drill bit.
- Strengthens the core to increase overall flute durability.

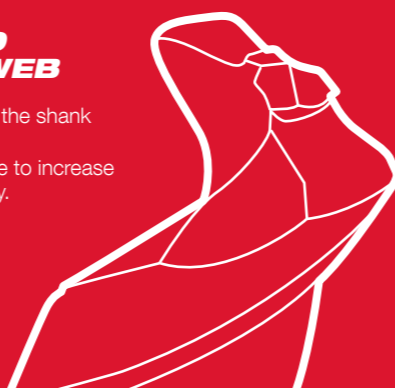

Quad Edge™ Tip on sizes > Ø 4.5 mm. 3-Flat on HSS-Co sizes > Ø 5 mm.

SHOCKWAVE
IMPACT DUTY

RED HEX

RED HEX - SHOCKWAVE™ HSS-TiN metal drill bits

Impact rated drill bit with 1/4" hex shank optimised for impact drivers.
Titanium Nitride coating dispenses heat and makes the drill bit suitable for use also in high speed.
QUAD EDGE™ Tip: unique combination of 135° split point and four cutting edges: 135° split point allows for precise & fast drilling start without walking. Four cutting edges create smaller chips to prevent heat build up for longer life.

Diameter (mm)	Total length (mm) A	Working length (mm) B	Pack quantity	Min. order quantity	Article Number	EAN Code
2	59.5	17	2	1	48894703	045242501557
2.5	62	19	2	1	48894704	045242501564
3	65	23	2	1	48894763	045242506866
3.2	66.5	23	2	1	48894706	045242501571
3.3	67	24	2	1	4932471089	4058546287177
3.5	69	25	2	1	48894707	045242501588
4	71.5	26	2	1	48894708	045242501595
4.2	74	28	1	1	48894709	045242501601
4.5	76	29	1	1	48894710	045242501618
4.8	78	29	1	1	48894711	045242501625
5	80	31	1	1	48894712	045242501632
5.5	104	60	1	1	48894764	045242506873
6	105	63	1	1	48894714	045242501649
6.5	107	64	1	1	48894715	045242501656
6.8	108	65	1	1	48894716	045242501663
7	109	66	1	1	48894717	045242501670
7.5	110	67	1	1	48894718	045242501687
8	111	70	1	1	48894719	045242501694
8.5	114	72	1	1	48894720	045242501700
9	117	73	1	1	48894721	045242501717
9.5	118	74	1	1	48894722	045242501724
10	120	76	1	1	48894723	045242501731
10.2	121	77	1	1	4932471090	4058546287184
10.5	122	78	1	1	48894724	045242501748
11	125	80	1	1	48894725	045242501755
11.5	126	81	1	1	48894726	045242501762
12	127	82	1	1	48894727	045242501779
12.5	128	83	1	1	48894728	045242501786
13	130	83	1	1	48894729	045242501793

SHOCKWAVE™ HSS-G TiN Red Hex drill bits set (10pc)	10	1	4932493865	4058546510251
Ø 3 / 3.5 / 4 / 4.5 / 5 / 6 / 7 / 8 / 9 / 10 mm				
Shockwave HSS-G TiN Red Hex Set CB (19pc)	19	1	4932499763	4058546569273
Ø 2 / 2.5 / 3 / 3.2 / 3.5 / 4 / 4.5 / 4.8 / 5 / 5.5 / 6 / 6.5 / 7 / 7.5 / 8 / 8.5 / 9 / 9.5 / 10 mm				
Shockwave HSS-G TiN Red Hex Set (25pc)	25	1	4932500420	4058546617226
Ø 2 / 2.5 / 3 / 3.2 / 3.5 / 4 / 4.5 / 4.8 / 5 / 5.5 / 6 / 6.5 / 7 / 7.5 / 8 / 8.5 / 9 / 9.5 / 10 / 10.5 / 11 / 11.5 / 12 / 12.5 / 13mm				

Diameter (mm)	Total length (mm) A	Working length (mm) B	Pack quantity	Min. order quantity	Article Number	EAN Code
2.5	62	19	10	1	4932478175	4058546341084
3.0	65	23	10	1	4932478176	4058546341091
3.5	69	25	10	1	4932478177	4058546341107
4.0	71.5	26	10	1	4932478178	4058546341114
4.5	76	29	10	1	4932478179	4058546341121
5.0	80	31	10	1	4932478180	4058546341138
6.0	105	63	10	1	4932478181	4058546341145
7.0	109	66	5	1	4932478182	4058546341152
8.0	111	70	5	1	4932478183	4058546341169
10.0	120	76	5	1	4932478184	4058546341176
10.5	122	39	5	1	4932500414	4058546617165
11	125	40.5	5	1	4932500415	4058546617172
11.5	126	41	5	1	4932500416	4058546617189
12	127	41.5	5	1	4932500417	4058546617196
12.5	128	41.5	5	1	4932500418	4058546617202
13	130	42.5	5	1	4932500419	4058546617219



Ø

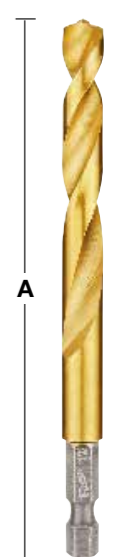

DESIGNED FOR USE IN
PACKOUT



RED COBALT - HSS-Ground - DIN 338 Cobalt metal drill bits

Metal drill bits ground from solid, extremely heat resistant 5% cobalt-alloyed high speed steel produced according to DIN 338.

Suitable for drilling high alloy content steels and metals with tensile strengths over 1000 N/mm² like stainless steel.

QUAD EDGE™ Tip: unique combination of 135° split point and four cutting edges: 135° split point allows for precise & fast drilling start without walking. Four cutting edges create smaller chips to prevent heat build up for longer life.

Variable flute geometry: For faster material ejection. Helps the bit run cooler and prevent it from burning out faster.

Enhanced tapered web: Wider core towards the shank of the drill bit. Strengthens the core to increase overall flute durability.

3-flat shank from Ø 5 mm for better grip and prevents chuck slippage.

Colour: bronze.

**RED
COBALT**

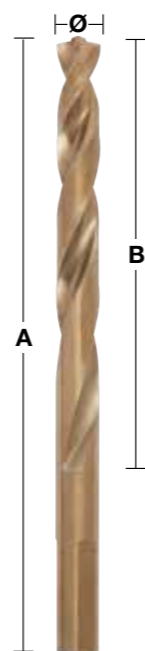

**DESIGNED FOR USE IN
PACKOUT™**



Diameter (mm)	Total length (mm) A	Working length (mm) B	Pack quantity	Min. order quantity	Article Number	EAN Code
1.0	34	12	2	1	4932363248	4002395333080
1.5	40	18	2	1	4932363249	4002395333097
2.0	49	24	2	1	4932363250	4002395333103
2.5	57	30	2	1	4932363251	4002395333110
3.0	61	33	2	1	4932363253	4002395333134
3.2	65	36	2	1	4932363254	4002395333141
3.3	67	37	2	1	4932471140	4058546287689
3.5	70	39	2	1	4932363256	4002395333165
4.0	75	43	2	1	4932363258	4002395333189
4.2	75	43	1	1	4932363260	4002395333202
4.5	80	47	1	1	4932363262	4002395333226
4.8	86	52	1	1	4932363263	4002395333233
5.0	86	52	1	1	4932363264	4002395333240
5.5	93	57	1	1	4932363267	4002395333271
6.0	93	57	1	1	4932363268	4002395333288
6.5	101	63	1	1	4932363269	4002395333295
6.8	109	69	1	1	4932363270	4002395333301
7.0	109	69	1	1	4932363271	4002395333318
7.5	109	69	1	1	4932363272	4002395333325
8.0	117	75	1	1	4932363274	4002395333349
8.5	117	75	1	1	4932363276	4002395333363
9.0	125	81	1	1	4932363277	4002395333370
9.5	125	81	1	1	4932363278	4002395333387
10.0	133	87	1	1	4932363279	4002395333394
10.2	133	87	1	1	4932471141	4058546287696
10.5	133	87	1	1	4932363281	4002395333417
11.0	142	94	1	1	4932363282	4002395333424
11.5	142	94	1	1	4932363283	4002395333431
12.0	151	101	1	1	4932363284	4002395333448
12.5	151	101	1	1	4932363285	4002395333455
13.0	151	101	1	1	4932363286	4002395333462
① RED COBALT HSS-Ground set (8pc) Ø3 / 4 / 5 / 6 / 7 / 8 / 9 / 10 mm			8	1	4932499256	4058546564209
② RED COBALT HSS-Ground set (19pc) Ø1 / 1.5 / 2 / 2.5 / 3 / 3.5 / 4 / 4.5 / 5 / 5.5 / 6 / 6.5 / 7 / 7.5 / 8 / 8.5 / 9 / 9.5 / 10 mm			19	1	4932499764	4058546569280
③ RED COBALT HSS-Ground set (25pc) Ø1 / 1.5 / 2 / 2.5 / 3 / 3.5 / 4 / 4.5 / 5 / 5.5 / 6 / 6.5 / 7 / 7.5 / 8 / 8.5 / 9 / 9.5 / 10 / 10.5 / 11 / 11.5 / 12 / 12.5 / 13 mm			25	1	4932499765	4058546569297

RED COBALT - HSS-Ground - DIN 338 Cobalt metal drill bits - 5 and 10 pack

Diameter (mm)	Total length (mm) A	Working length (mm) B	Pack quantity	Min. order quantity	Article Number	EAN Code
6.8	109	69	5	1	4932373347	4002395347124
7.0	109	69	5	1	4932373348	4002395347131
7.5	109	69	5	1	4932373349	4002395347148
8.0	117	75	5	1	4932373350	4002395347155
8.5	117	75	5	1	4932373351	4002395347162
9.0	125	81	5	1	4932373352	4002395347179
9.5	125	81	5	1	4932373353	4002395347186
10.0	133	87	5	1	4932373354	4002395347193
10.2	133	87	5	1	4932471143	4058546287719
10.5	133	87	5	1	4932373355	4002395347803
11.0	142	94	5	1	4932373356	4002395347810
11.5	142	94	5	1	4932373357	4002395347827
12.0	151	101	5	1	4932373358	4002395347834
12.5	151	101	5	1	4932373359	4002395347841
13.0	151	101	5	1	4932373360	4002395347858
1.0	34	12	10	1	4932373332	4002395349173
1.5	40	18	10	1	4932373333	4002395349180
2.0	49	24	10	1	4932373334	4002395349197
2.5	57	30	10	1	4932373335	4002395349807
3.0	61	33	10	1	4932373336	4002395349814
3.2	65	36	10	1	4932373337	4002395349821
3.3	67	37	10	1	4932471142	4058546287702
3.5	70	39	10	1	4932373338	4002395349838
4.0	75	43	10	1	4932373339	4002395349845
4.2	75	43	10	1	4932373340	4002395349852
4.5	80	47	10	1	4932373341	4002395349869
4.8	86	52	10	1	4932373342	4002395349876
5.0	86	52	10	1	4932373343	4002395349883
5.5	93	57	10	1	4932373344	4002395349890
6.0	93	57	10	1	4932373345	4002395347100
6.5	101	63	10	1	4932373346	4002395347117

**RED
COBALT**

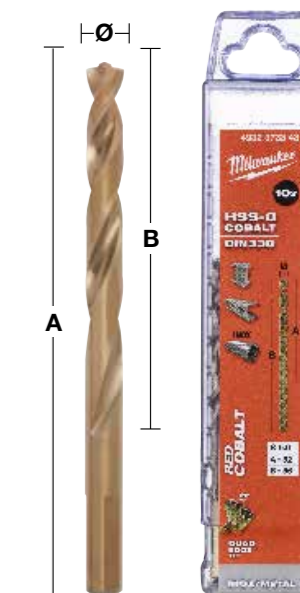

Countersinks-HSS

According to DIN 335C / 90° angle.
Cutting edges: 3
Deburring and countersinking in one go according to DIN74/75.
Cutting geometry optimised for easy centering, good chip removal and low vibrations.
Best lifetime is achieved when used with lubricant.
Suitable for steel < 900 N/mm², aluminium and plastics.

Diameter (mm)	Screw size	Shank diameter (mm)	Total length (mm)	Pack quantity	Min. order quantity	Article Number	EAN Code
6.3	M3	5	45	1	1	4932493969	4058546511296
8.3	M4	6	50	1	1	4932493970	4058546511302
10.4	M5	6	50	1	1	4932493971	4058546511319
12.4	M6	8	56	1	1	4932493972	4058546511326
16.5	M8	10	60	1	1	4932493973	4058546511333
20.5	M10	10	63	1	1	4932493974	4058546511340
Countersink set HSS - 6 pc				6	1	4932493574	4058546484453



Countersinks-HSS Cobalt

According to DIN 335C / 90° angle.
Cutting edges: 3
Deburring and countersinking in one go according to DIN74/75.
Cutting geometry optimised for easy centering, good chip removal and low vibrations.
Up to 50% longer lifetime vs. standard HSS countersinks. Requires less feedforce.
Best lifetime is achieved when used with lubricant.
Suitable for steel and stainless steel < 1100 N/mm², cast iron, aluminium and plastics.

Diameter (mm)	Screw size	Shank diameter (mm)	Total length A (m)	Pack quantity	Min. order quantity	Article Number	EAN Code
6.3	M3	5	45	1	1	4932493975	4058546511357
8.3	M4	6	50	1	1	4932493976	4058546511364
10.4	M5	6	50	1	1	4932493977	4058546511371
12.4	M6	8	56	1	1	4932493978	4058546511388
16.5	M8	10	60	1	1	4932493979	4058546511395
20.5	M10	10	63	1	1	4932493980	4058546511401
Countersink set HSS Co - 6 pc				6	1	4932493575	4058546484460



Material Quality	HSS	HSS Cobalt
Steel (N/mm ²) < 900	✓	✓
Steel (N/mm ²) < 1300	◆	✓
Stainless Steel		✓
Aluminium	✓	✓
Cast Iron	◆	✓
Plastics	✓	

THUNDERWEB

Metal drill bits HSS Ground - DIN 338

Milwaukee **THUNDERWEB**

The **THUNDERWEB** design is characterised by a conical shaped web which gets thicker towards the back of the drill bit. The web is the internal core of the drill bit.

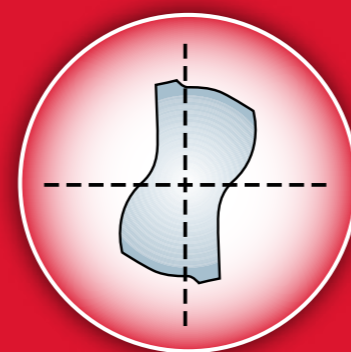

Parabolic web cross section

- Large web thickness. Strength built in.
- Accepts higher feed pressure and torque.
- Less breakages. Good for drilling deep holes and on curved surfaces.
- Long life.



Standard drill bit

The web on standard drill bits is a constant thickness throughout the length of the bit.

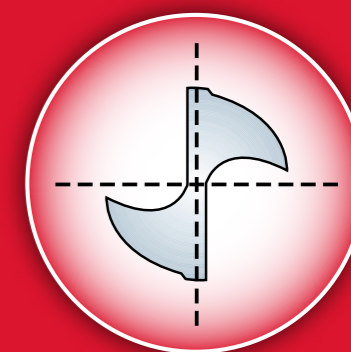

Conventional type web cross section

THUNDERWEB SPECIFICATION

FLUTE GEOMETRY

- **THUNDERWEB** flute form ejects hot chips rapidly. Disseparates heat better increasing lifetime.
- Open flute form reduces drill drawback when drilling deeper holes.
- Sharpened edges reduce binding for faster cleaner cuts.
- Flatter twist angle creates smaller chippings, ideal for drilling harder steels ie. stainless steel.

135° SPLIT POINT

- Precision starting, drill bit won't walk.
- Penetrates quickly.
- Good for drilling on curved surfaces.
- Requires less effort/feed pressure.
- Excellent for very hard materials.



THUNDERWEB - HSS-Ground metal drill bits - DIN338

Diameter (mm)	Total length (mm) A	Working length (mm) B	Pack quantity	Min. order quantity	Article Number	EAN Code
1.0	34	12	2	1	4932352345	4002395370047
1.5	40	18	2	1	4932352346	4002395370054
2.0	49	24	2	1	4932352347	4002395370061
2.5	57	30	2	1	4932352348	4002395370078
3.0	61	33	2	1	4932352349	4002395370085
3.2	65	36	2	1	4932352350	4002395370092
3.5	70	39	2	1	4932352351	4002395370108
4.0	75	43	2	1	4932352352	4002395370115
4.2	75	43	1	1	4932352353	4002395370122
4.5	80	47	1	1	4932352354	4002395370139
4.8	86	52	1	1	4932352355	4002395370146
5.0	86	52	1	1	4932352356	4002395370153
5.5	93	57	1	1	4932352357	4002395370160
6.0	93	57	1	1	4932352358	4002395370177
6.5	101	63	1	1	4932352359	4002395370184
6.8	109	69	1	1	4932352360	4002395370191
7.0	109	69	1	1	4932352361	4002395370207
7.5	109	69	1	1	4932352362	4002395370214
8.0	117	75	1	1	4932352363	4002395370221
8.5	117	75	1	1	4932352364	4002395370238
9.0	125	81	1	1	4932352365	4002395370245
9.5	125	81	1	1	4932352366	4002395370252
10.0	133	87	1	1	4932352367	4002395370269
10.5	133	87	1	1	4932352368	4002395370276
11.0	142	94	1	1	4932352369	4002395370283
11.5	142	94	1	1	4932352370	4002395370290
12.0	151	101	1	1	4932352371	4002395370306
12.5	151	101	1	1	4932352372	4002395370313
13.0	151	101	1	1	4932352373	4002395370320
13.5	152	57	1	1	4932500400	4058546617028
14	152	57	1	1	4932500401	4058546617035
14.5	152	57	1	1	4932500402	4058546617042
15.0	152	57	1	1	4932500403	4058546617059
15.5	152	57	1	1	4932500404	4058546617066
16.0	152	57	1	1	4932500405	4058546617073
16.5	152	57	1	1	4932500406	4058546617080
17.0	152	57	1	1	4932500407	4058546617097
17.5	152	57	1	1	4932500408	4058546617103
18.0	152	57	1	1	4932500409	4058546617110
18.5	152	57	1	1	4932500410	4058546617127
19.0	152	57	1	1	4932500411	4058546617134
19.5	152	57	1	1	4932500412	4058546617141
20.0	152	57	1	1	4932500413	4058546617158
Thunderweb HSS-Ground set CB (19pc)						
①	Ø 1 / 1.5 / 2 / 2.5 / 3 / 3.5 / 4 / 4.5 / 5 / 5.5 / 6 / 6.5 / 7 / 7.5 / 8 / 8.5 / 9 / 9.5 / 10 mm		19	1	4932499766	4058546569303
Thunderweb HSS-Ground set CB (25pc)						
②	Ø 1 / 1.5 / 2 / 2.5 / 3 / 3.5 / 4 / 4.5 / 5 / 5.5 / 6 / 6.5 / 7 / 7.5 / 8 / 8.5 / 9 / 9.5 / 10 / 10.5 / 11 / 11.5 / 12 / 12.5 / 13 mm		25	1	4932499767	4058546569310



THUNDERWEB - DIN 338 - 5 and 10 pack

Diameter (mm)	Total length (mm)	Working length (mm)	Pack quantity	Min. order quantity	Article Number	EAN Code
1	34	12	10	1	4932352377	4002395370368
1.1	36	14	10	1	4932459826	4058546029982
1.2	38	16	10	1	4932459827	4058546029999
1.3	38	16	10	1	4932459828	4058546030001
1.4	40	18	10	1	4932459829	4058546030018
1.5	40	18	10	1	4932352378	4002395370375
1.6	43	20	10	1	4932459830	4058546030025
1.7	43	20	10	1	4932459831	4058546030032
1.8	46	22	10	1	4932459832	4058546030049
1.9	46	22	10	1	4932459833	4058546030056
2	49	24	10	1	4932352379	4002395370382
2.1	49	24	10	1	4932459834	4058546030063
2.2	53	27	10	1	4932459835	4058546030070
2.3	53	27	10	1	4932459836	4058546030087
2.4	57	30	10	1	4932430569	4002395382309
2.5	57	30	10	1	4932352380	4002395370399
2.6	57	30	10	1	4932459837	4058546030094
2.7	61	33	10	1	4932459838	4058546030100
2.8	61	33	10	1	4932459839	4058546030117
2.9	61	33	10	1	4932459840	4058546030124
3	61	33	10	1	4932352381	4002395370405
3.1	65	36	10	1	4932459841	4058546030131
3.2	65	36	10	1	4932352382	4002395370412
3.3	65	36	10	1	4932459842	4058546030148
3.4	70	39	10	1	4932459843	4058546030155



THUNDERWEB - DIN 338 - 5 and 10 pack

Diameter (mm)	Total length (mm)	Working length (mm)	Pack quantity	Min. order quantity	Article Number	EAN Code
3.5	70	39	10	1	4932352383	4002395370429
3.6	70	39	10	1	4932459844	4058546030162
3.7	70	39	10	1	4932459845	4058546030179
3.8	75	43	10	1	4932430547	4002395382088
3.9	75	43	10	1	4932459846	4058546030186
4	75	43	10	1	4932352384	4002395370436
4.1	75	43	10	1	4932459847	4058546030193
4.2	75	43	10	1	4932352385	4002395370443
4.3	80	47	10	1	4932459848	4058546030209
4.4	80	47	10	1	4932459849	4058546030216
4.5	80	47	10	1	4932352386	4002395370450
4.6	80	47	10	1	4932459850	4058546030223
4.7	80	47	10	1	4932459851	4058546030230
4.8	86	52	10	1	4932352387	4002395370467
4.9	86	52	10	1	4932459852	4058546030247
5	86	52	10	1	4932352388	4002395370474
5.1	86	52	10	1	4932459853	4058546030254
5.2	86	52	10	1	4932430548	4002395382095
5.3	86	52	10	1	4932459854	4058546030261
5.4	93	57	10	1	4932459855	4058546030278
5.5	93	57	10	1	4932352389	4002395370481
5.6	93	57	10	1	4932430570	4002395382316
5.7	93	57	10	1	4932459856	4058546030285
5.8	93	57	10	1	4932430549	4002395382101
5.9	93	57	10	1	4932459857	4058546030292
6	93	57	10	1	4932352390	4002395370498
6.1	101	63	10	1	4932459858	4058546030308
6.2	101	63	10	1	4932430550	4002395382118
6.3	101	63	10	1	4932459859	4058546030315
6.4	101	63	10	1	4932430571	4002395382323
6.5	101	63	10	1	4932352391	4002395370504
6.6	101	63	5	1	4932459860	4058546030322
6.7	101	63	5	1	4932459861	4058546030339
6.8	109	69	5	1	4932352392	4002395370511
6.9	109	69	5	1	4932459862	4058546030346
7	109	69	5	1	4932352393	4002395370528
7.1	109	69	5	1	4932459863	4058546030353
7.2	109	69	5	1	4932430551	4002395382125
7.3	109	69	5	1	4932459864	4058546030360
7.4	109	69	5	1	4932459865	4058546030377
7.5	109	69	5	1	4932352394	4002395370535
7.6	117	75	5	1	4932459866	4058546030384
7.7	117	75	5	1	4932459867	4058546030391
7.8	117	75	5	1	4932459868	4058546030407
7.9	117	75	5	1	4932459869	4058546030414
8	117	75	5	1	4932352395	4002395370542
8.1	117	75	5	1	4932459870	4058546030421
8.2	117	75	5	1	4932430552	4002395382132
8.3	117	75	5	1	4932459871	4058546030438
8.4	117	75	5	1	4932430553	4002395382149
8.5	117	75	5	1	4932352396	4002395370559
8.6	125	81	5	1	4932459872	4058546030445
8.7	125	81	5	1	4932459873	4058546030452
8.8	125	81	5	1	4932459874	4058546030469
8.9	125	81	5	1	4932459875	4058546030476
9	125	81	5	1	4932352397	4002395370566
9.1	125	81	5	1	4932459876	4058546030483
9.2	125	81	5	1	4932459877	4058546030490
9.3	125	81	5	1	4932459878	4058546030506
9.4	125	81	5	1	4932459879	4058546030513
9.5	125	81	5	1	4932352398	4002395370573
9.6	133	87	5	1	4932459880	4058546030520
9.7	133	87	5	1	4932459881	4058546030537
9.8	133	87	5	1	4932459882	4058546030544
9.9	133	87	5	1	4932459883	4058546030551



THUNDERWEB - DIN 338 - 5 and 10 pack

Diameter (mm)	Total length (mm)	Working length (mm)	Pack quantity	Min. order quantity	Article Number	EAN Code
10	133	87	5	1	4932352399	4002395370580
10.5	133	87	5	1	4932352400	4002395370597
11	142	94	5	1	4932352401	4002395370603
11.5	142	94	5	1	4932352402	4002395370610
12	151	101	5	1	4932352403	4002395370627
12.5	151	101	5	1	4932352404	4002395370634
13	151	101	5	1	4932352405	4002395370641



THUNDERWEB - DIN 338 - cassettes

Description	Supplied in	Pack quantity	Min. order quantity	Article Number	EAN Code
THUNDERWEB HSS-G set (19pc)					
Ø 1 / 1.5 / 2 / 2.5 / 3 / 3.5 / 4 / 4.5 / 5 / 5.5 / 6 / 6.5 / 7 / 7.5 / 8 / 8.5 / 9 / 9.5 / 10 mm	Plastic cassette	19	1	4932499766	4058546569303
THUNDERWEB HSS-G set (25pc)					
Ø 1 / 1.5 / 2 / 2.5 / 3 / 3.5 / 4 / 4.5 / 5 / 5.5 / 6 / 6.5 / 7 / 7.5 / 8 / 8.5 / 9 / 9.5 / 10 / 10.5 / 11 / 11.5 / 12 / 12.5 / 13 mm	Plastic cassette	25	1	4932499767	4058546569310

DESIGNED FOR USE IN **PACKOUT**



HSS-G metal drill bits - long - DIN 340 - 5 and 10 pack

High quality high speed steel.
Split point DIN 1412 C.
Right hand cutting edge.
135° angle for improved centering.
Most suitable for drilling deep holes in channels or where there are hollow sections.
Suitable for drilling steel, cast iron, alloyed and non alloyed material up to 900 N/mm².
Also suitable for wood and plastics.



Diameter (mm)	Total length (mm) A	Working length (mm) B	Pack quantity	Min. order quantity	Article Number	EAN Code
2.0	85	56	10	1	4932430328	4002395379897
2.5	95	62	10	1	4932430329	4002395379903
3.0	100	66	10	1	4932430330	4002395379910
3.5	112	73	10	1	4932430331	4002395379927
4.0	119	78	10	1	4932430332	4002395379934
4.5	126	82	10	1	4932430333	4002395379941
5.0	132	87	10	1	4932430334	4002395379958
5.5	139	91	10	1	4932430335	4002395379965
6.0	139	91	10	1	4932430336	4002395379972
6.5	148	97	10	1	4932430337	4002395379989
7.0	156	102	10	1	4932430338	4002395379996
8.0	165	109	10	1	4932430339	4002395380008
9.0	175	115	10	1	4932430340	4002395380015
10.0	184	121	10	1	4932430341	4002395380022
11.0	195	128	5	1	4932430342	4002395380039
12.0	205	134	5	1	4932430343	4002395380046
13.0	205	134	5	1	4932430344	4002395380053

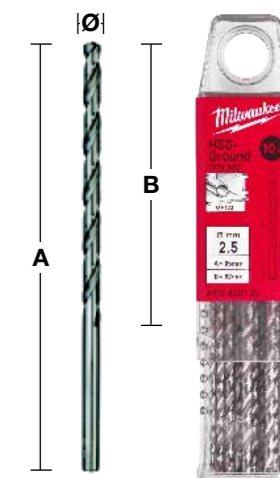

HSS-G metal drill bits - short - DIN 1897 - 5 and 10 pack

Drill bit quality: High quality high speed steel.
Tip geometry: Split Point DIN 1412 C.
Point angle: 135°. Tolerance: h8.
Flute / Helix angle: Type N flute and normal 20 - 30° angle.
Right hand cutting edge. Surface / Colour: Polished silver.
Withstands high drill point pressure due to short overall length.
Excellent concentricity. Polished type N flute with right hand cutting edge, eliminates binding for faster chip removal and faster cutting with less effort.
Application: Most suited for drilling sheet and thin walled materials.
Suitable for drilling in sheet steel, thin alloyed and non-alloyed material up to 900 N/mm².
Also suitable for wood and plastics.

Diameter (mm)	Total length (mm) A	Working length (mm) B	Pack quantity	Min. order quantity	Article Number	EAN Code
2.0	38	12	10	1	4932352200	4002395368532
2.5	43	14	10	1	4932352201	4002395368549
3.0	46	16	10	1	4932352202	4002395368556
3.2	49	18	10	1	4932352203	4002395368563
3.3	49	18	10	1	4932352204	4002395368570
3.5	52	20	10	1	4932352205	4002395368587
3.7	52	20	10	1	4932352206	4002395368594
4.0	55	22	10	1	4932352207	4002395368600
4.2	55	22	10	1	4932352208	4002395368617
4.5	58	24	10	1	4932352209	4002395368624
4.8	62	26	10	1	4932352210	4002395368631
5.0	62	26	10	1	4932352211	4002395368648
5.2	62	26	10	1	4932352212	4002395368655
5.5	66	28	10	1	4932352213	4002395368662
6.0	66	28	10	1	4932352214	4002395368679
6.5	70	31	10	1	4932352215	4002395368686
7.0	74	34	5	1	4932352216	4002395368693
7.5	74	34	5	1	4932352217	4002395368709
8.0	79	37	5	1	4932352218	4002395368716
8.5	79	37	5	1	4932352219	4002395368723
9.0	84	40	5	1	4932352220	4002395368730
10.0	89	43	5	1	4932352221	4002395368747

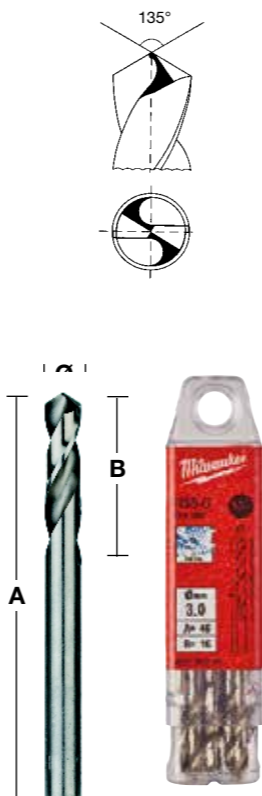

Metal drill bits HSS rollforged - DIN 338 - 5 and 10 pack

High speed steel rollforged metal drill bits produced according to DIN 338.
Oxide coating enables quick swarf removal. Normal point shaped cutting tip with 118° angle.
Type N flute normal angle.
Suitable for drilling in steel, cast iron, alloyed and non-alloyed material up to 800 N/mm².
Colour: black.

Diameter (mm)	Total length (mm) A	Working length (mm) B	Pack quantity	Min. order quantity	Article Number	EAN Code
1.0	34	12	10	1	4932363444	4002395329458
1.5	40	18	10	1	4932363449	4002395329502
2.0	49	24	10	1	4932363454	4002395329557
2.5	57	30	10	1	4932363459	4002395329601
3.0	61	33	10	1	4932363464	4002395329656
3.2	65	36	10	1	4932363466	4002395329670
3.5	70	39	10	1	4932363469	4002395329700
4.0	75	43	10	1	4932363474	4002395329755
4.2	75	43	10	1	4932363476	4002395329779
4.5	80	47	10	1	4932363479	4002395329809
4.8	86	52	10	1	4932363482	4002395329830
5.0	86	52	10	1	4932363484	4002395329854
5.5	93	57	10	1	4932363489	4002395329908
6.0	93	57	10	1	4932363494	4002395329953
6.5	101	63	10	1	4932363499	4002395330003
6.8	109	69	10	1	4932363502	4002395330034
7.0	109	69	10	1	4932363504	4002395330058
7.5	109	69	10	1	4932363509	4002395330102
8.0	117	75	10	1	4932363514	4002395330157
8.5	117	75	10	1	4932363519	4002395330201
9.0	125	81	10	1	4932363524	4002395330256
9.5	125	81	10	1	4932363529	4002395330300
10.0	133	87	10	1	4932363534	4002395330355
10.5	133	87	5	1	4932363539	4002395330409
11.0	142	94	5	1	4932363544	4002395330454
11.5	142	94	5	1	4932363549	4002395330508
12.0	151	101	5	1	4932363554	4002395330553
12.5	151	101	5	1	4932363559	4002395330607
13.0	151	101	5	1	4932363564	4002395330652



HSS-G metal drill bits - double ended - 10 pack

Drill bit quality: High quality high speed steel. Tip geometry: Split Point DIN 1412 C. Point angle: 135°
Tolerance: h8. Flute / Helix angle: Type N flute and normal 20 - 30° angle.
Right hand cutting edge. Surface / Colour: Polished silver.
Split point tip for good centering. Both ends can be used.
Due to its short length it can be used with higher feed pressure without the risk of breakage.
Excellent concentricity. Polished type N flute with right hand cutting edge, eliminates binding for faster chip removal and faster cutting with less effort.
Application: Suitable drilling in steel, non-ferrous metals and plastic. Most suitable for thin sheet materials e.g. rivet holes.

Diameter (mm)	Total length (mm) A	Working length (mm) B	Pack quantity	Min. order quantity	Article Number	EAN Code
2.5	43	10	10	1	4932352222	4002395368754
3.0	46	11	10	1	4932352223	4002395368761
3.2	49	12	10	1	4932352224	4002395368778
3.3	49	12	10	1	4932352225	4002395368785
3.5	52	14	10	1	4932352226	4002395368792
4.0	55	14	10	1	4932352227	4002395368808
4.1	55	14	10	1	4932352228	4002395368815
4.2	55	14	10	1	4932352229	4002395368822
4.5	58	16	10	1	4932352230	4002395368839
4.8	62	18	10	1	4932352231	4002395368846
5.0	62	18	10	1	4932352232	4002395368853
5.5	66	19	10	1	4932352233	4002395368860
6.0	66	19	10	1	4932352234	4002395368877



Metal drill bits HSS rollforged - DIN 338 - cassettes

Description	Supplied in	Pack quantity	Min. order quantity	Article Number	EAN Code
HSS-R drill bits set (19pc)					
① Ø 1 / 1.5 / 2 / 2.5 / 3 / 3.5 / 4 / 4.5 / 5 / 5.5 / 6 / 6.5 / 7 / 7.5 / 8 / 8.5 / 9 / 9.5 / 10 mm	Metal case	19	1	4932352468	4002395371273
HSS-R drill bits set (25pc)					
② Ø 1 / 1.5 / 2 / 2.5 / 3 / 3.5 / 4 / 4.5 / 5 / 5.5 / 6 / 6.5 / 7 / 7.5 / 8 / 8.5 / 9 / 9.5 / 10 / 10.5 / 11 / 11.5 / 12 / 12.5 / 13 mm	Metal case	25	1	4932352469	4002395371280



Metal drill bits HSS Rollforged - DIN 338 with reduced shank

High speed steel rollforged metal drill bits produced according to DIN 338.

Oxide coating enables quick swarf removal.

Normal point shaped cutting tip with 118° angle.

Type N flute normal angle.

Suitable for drilling in steel, cast iron, alloyed and non-alloyed material up to 800 N/mm².

Colour: black.

Ø 13.5 mm - Ø 16 mm = 10 mm shank / Ø 16.5 mm - Ø 20 mm = 13 mm shank.

Diameter (mm)	Total length (mm) A	Working length (mm) B	Pack quantity	Min. order quantity	Article Number	EAN Code
13.5	160	108	1	1	4932373318	4002395348435
14.0	160	108	1	1	4932373319	4002395348442
14.5	169	108	1	1	4932373320	4002395348459
15.0	169	114	1	1	4932373321	4002395348466
15.5	178	120	1	1	4932373322	4002395348473
16.0	178	120	1	1	4932373323	4002395348480
16.5	184	125	1	1	4932373324	4002395348497
17.0	184	125	1	1	4932373325	4002395349104
17.5	191	130	1	1	4932373326	4002395349111
18.0	191	130	1	1	4932373327	4002395349128
18.5	198	135	1	1	4932373328	4002395349135
19.0	198	135	1	1	4932373329	4002395349142
19.5	205	140	1	1	4932373330	4002395349159
20.0	205	140	1	1	4932373331	4002395349166



Metal drill bits HSS rollforged - DIN 338 - 345 pc cabinet

Diameter (mm)	Total length (mm) A	Working length (mm) B	Pack quantity	Min. order quantity	Article Number	EAN Code
Metal drill bit cabinet with HSS rollforged metal drill bits (345pc)			345	1	4932352674	4002395373321
1.0	34	12	20			
1.5	40	18	20			
2	49	24	20			
2.5	57	30	20			
3	61	33	20			
3.5	70	39	20			
4	75	43	20			
4.5	80	47	20			
5	86	52	20			
5.5	93	57	20			
6	93	57	20			
6.5	101	63	20			
7	109	69	10			
7.5	109	69	10			
8	117	75	20			
8.5	117	75	10			
9	125	81	10			
9.5	125	81	5			
10	133	87	10			
10.5	133	87	5			
11	142	94	5			
11.5	142	94	5			
12	151	101	5			
12.5	151	101	5			
13	151	101	5			



HSS G Combi Drill Tap

3 in 1 combination HSS-G drill bit: drilling, threading and deburring in one single operation.

Suitable for use with battery powered or corded drills.

Reception: 1/4" hex, E6.3.

Impact rated : suitable for use with cordless impact drivers when keeping to recommended drilling speed.

Thread type: metric ISO-thread DIN 13.

Suitable for drilling in plastics, sheet steel and non-alloyed material up to 800 N/mm².

Always use a suitable cutting oil.

Length (mm)	Screw size	Pack quantity	Min. order quantity	Article Number	EAN Code
52	M3	1	1	4932498261	4058546521301
52	M4	1	1	4932498262	4058546521318
57	M5	1	1	4932498263	4058546521325
57	M6	1	1	4932498264	4058546521332
57	M8	1	1	4932498265	4058546521349
58	M10	1	1	4932498266	4058546521356

1/4" HSS-G Combi Drill Tap Set - 6 pc

6 1 4932498267 4058546521363

M3, M4, M5, M6, M8, M10



DESIGNED FOR USE IN
PACKOUT



COBALT STEP DRILLS



New Aluminum Chromium Nitride (AlCrN) coating for 10x more life vs. MILWAUKEE® standard step drill. For steel and stainless steel.

MATERIALS:



- ① RAPID STRIKE TIP™: Accurate start without walking and fast drilling without the need to pre-drill the material.
- ② Optimised 2 flute ground sharpened edge geometry for 2 x faster and smoother cutting.
- ③ Special tip and step geometry for jam-free performance - less risk of drill snagging when used with high speed cordless tools and also prevents deformation of the drilled material.
- ④ Produced from custom engineered steel with black oxide coating for 4 x longer life.
- ⑤ Laser engraved size markings for best long term visibility.
- ⑥ Each step is relief ground to drill and deburr automatically.
- ⑦ With 3 flat secure grip to prevent step drill from slipping in the chuck and ensure maximum transmission of torque.



TRADES:



Drilling of panels and cabinets for cable gland installation



Access holes for pipework and installation



Various sizes and hole enlargement



Holes for cable installation



Various applications, sizes and hole enlargement

Cobalt ALCrN step drills

NEW

New Aluminium Chromium Nitride (AlCrN) coating for 10x more life vs. MILWAUKEE® standard step drill.

For steel and stainless steel.

RAPID STRIKE TIP™: Accurate start without walking and fast drilling without the need to pre-drill the material.

Special tip and step geometry for jam-free performance - less risk of drill snagging when used with cordless tools and also prevents deformation of the drilled material.

Optimised 2 flute ground sharpened edge geometry for 2 x faster and smoother cutting.

With 3 flat secure grip to prevent step drill from slipping in the chuck and ensure maximum transmission of torque.

Laser engraved size markings for best long term visibility.

Description	Shank diameter (mm)	Overall length (mm)	No. of steps	Pack quantity	Min. order quantity	Article Number	EAN Code
① 4 - 20 mm	8	62	10	1	1	48899372	045242603862
② 6 - 35 mm	10	86	16	1	1	48899395	045242567676
③ M6 - M32	10	90	14	1	1	48899380	045242567652
④ Cobalt Step Drill Set (2pc) Includes 2 cobalt step drill bits: 4 - 20 mm, 6 - 35 mm				2	1	48899398	045242529216

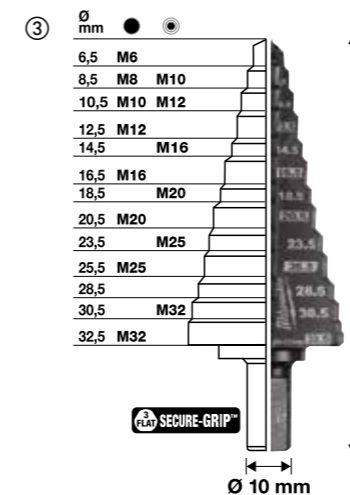
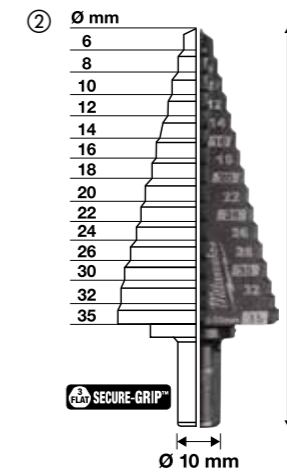
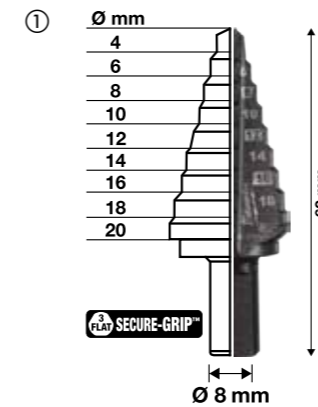

SHOCKWAVE™ IMPACT DUTY™

SHOCKWAVE™ IMPACT DUTY step drills

SHOCKWAVE™ Impact Duty step drills are designed to deliver best-in-class performance in impact drivers and also the versatility to be used in drill drivers.

The 1/4" Hex shank with an optimised SHOCKZONE™ ensures maximum durability by preventing early shank breaks.

New Titanium Aluminium Nitride coating helps to reduce heat generation for 5x more life.

RAPID STRIKE TIP™: Accurate start without walking and fast drilling without the need to pre-drill the material.

Dual spiral flute design: Optimised for impact driver speed and for smooth, jam-free drilling.

Laser engraved markings: Do not wear away with time.



Description	Shank diameter (mm)	Overall length (mm)	No. of steps	Pack quantity	Min. order quantity	Article Number	EAN Code
① 4 - 12 mm / 1"	1/4" Hex	83	9	1	1	48899261	045242505166
② 4 - 12 mm / 2"	1/4" Hex	83	5	1	1	48899262	045242505173
③ 4 - 20 mm	1/4" Hex	83	9	1	1	48899263	045242505180
④ 4 - 30 mm	1/4" Hex	95	12	1	1	48899265	045242505203
SHOCKWAVE™ Impact Duty step drill set (3pc)				3	1	48899266	045242505210
⑤ Includes 3 SHOCKWAVE™ step drill bits: 4 - 12 mm/1, 4 - 20 mm, 4 - 30 mm							

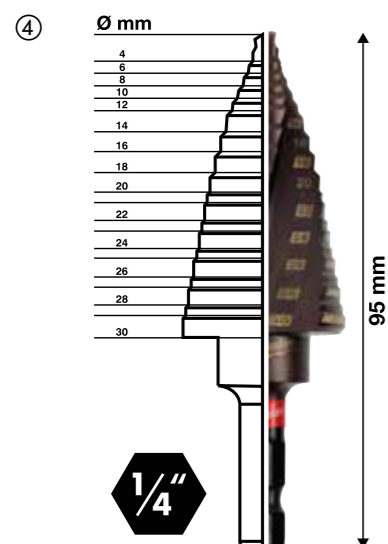
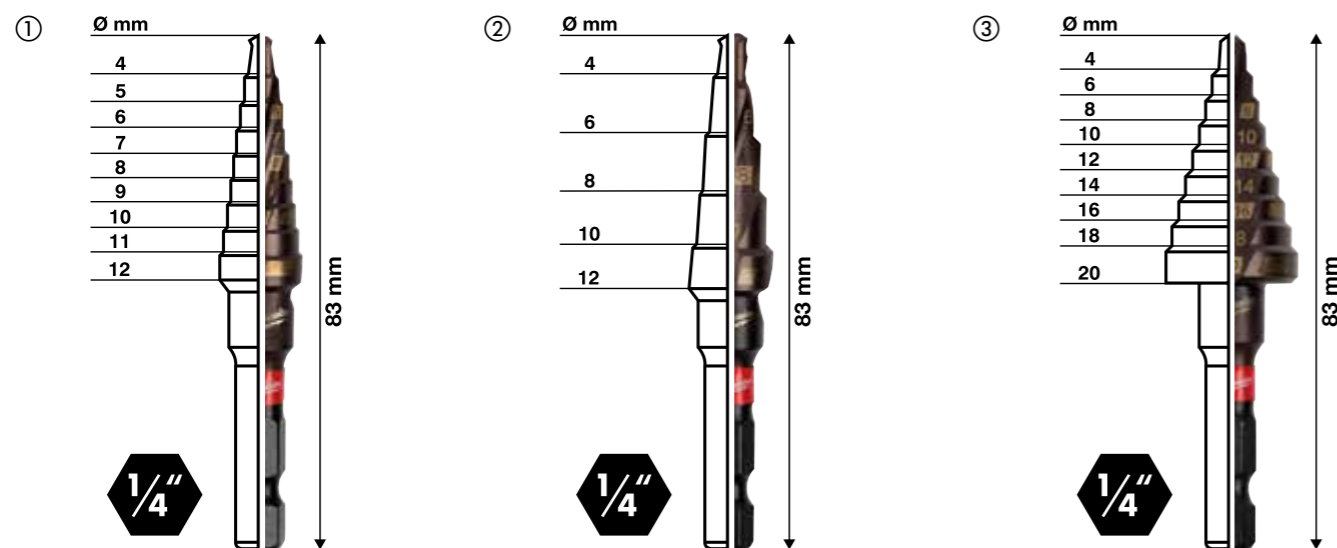

Step drills

Description	Shank diameter (mm)	Overall length (mm)	No. of steps	Pack quantity	Min. order quantity	Article Number	EAN Code
① PG7 - PG21	10	68	9	1	1	48899321	045242364060
② M6 - M32	10	92	13	1	1	48899332	045242344437
③ 4 - 12 mm / 1	6	65	9	1	1	48899301	045242342532
④ 4 - 20 mm	8	65	9	1	1	48899320	045242344406
⑤ 6 - 35 mm	10	90	14	1	1	48899335	045242344413
⑥ 6 - 40.5 mm	10	90	17	1	1	48899340	045242547777
Step drill set (3pc)				3	1	48899399	045242344420
⑦ Includes 3 step drill bits: 4 - 12 mm/1, 4 - 20 mm, 6 - 35 mm							
Step & drill bit combo set (10pc)				10	1	4932501119	4058546624217
⑧ Includes 2 x step drill bits: 4 - 12 mm/1, 4 - 20 mm. THUNDERWEB metal drill bits: 2 x 2 mm, 2 x 3 mm, 2 x 4 mm, 1 x 5 mm, 1 x 6 mm							

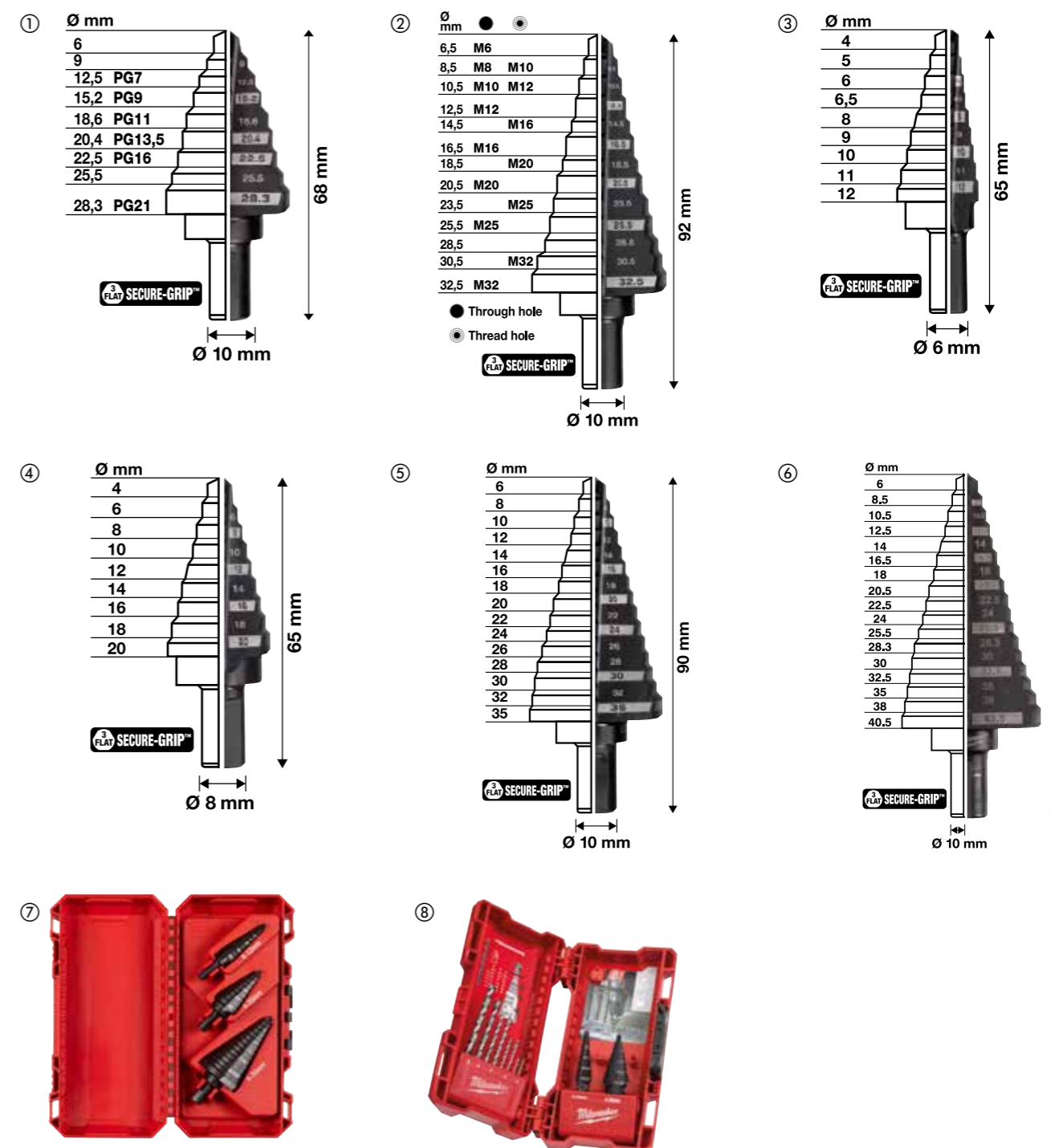

Magnetic Drilling

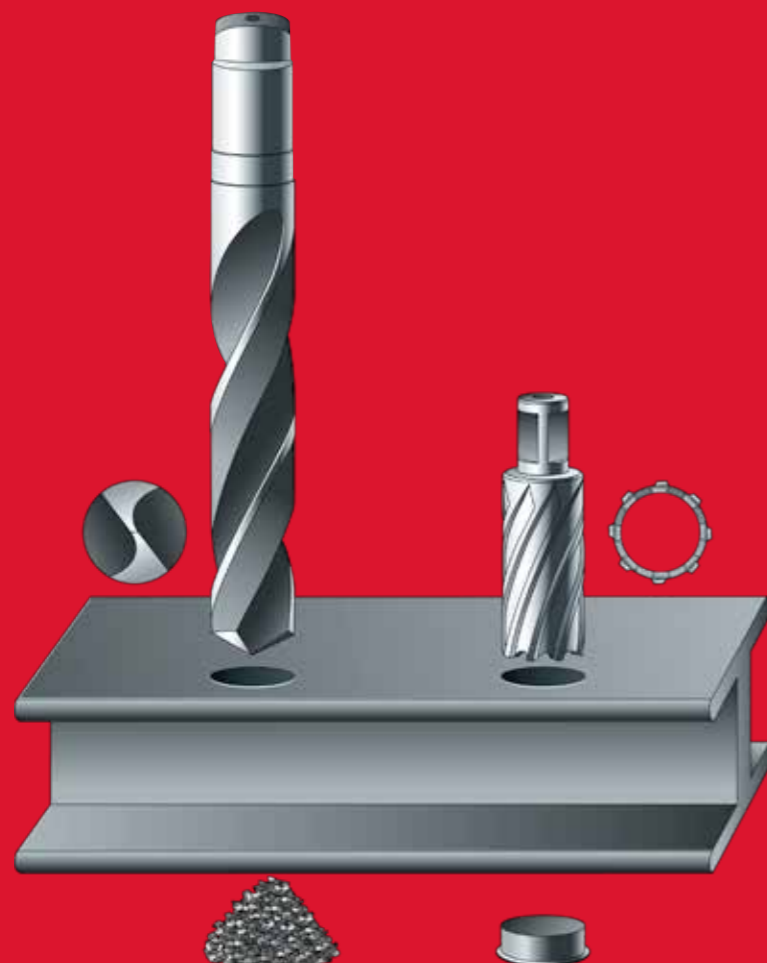

100% Faster

Speed and time savings are achieved due to the following factors. Firstly the annular cutter principle of only cutting material from the periphery of the hole as opposed to the twist drill which must cut the complete diameter of the hole. Secondly the benefit of two aggressive sharp angles per cutting edge help to achieve faster feed rates and lower cutting resistance.

30% More productivity

Because the annular cutter is only cutting material from the periphery of the hole. Less motor energy and driving power is required. The larger the drill diameter the greater the energy saving.

Longer lifetime

The annular cutters cutting edges do less work than the twist drill resulting in more holes between sharpening. Thick 6 mm body together with special tooth geometry ensures high stability and reduces to a minimum the risk of breakage due to overloading.

Speed chart

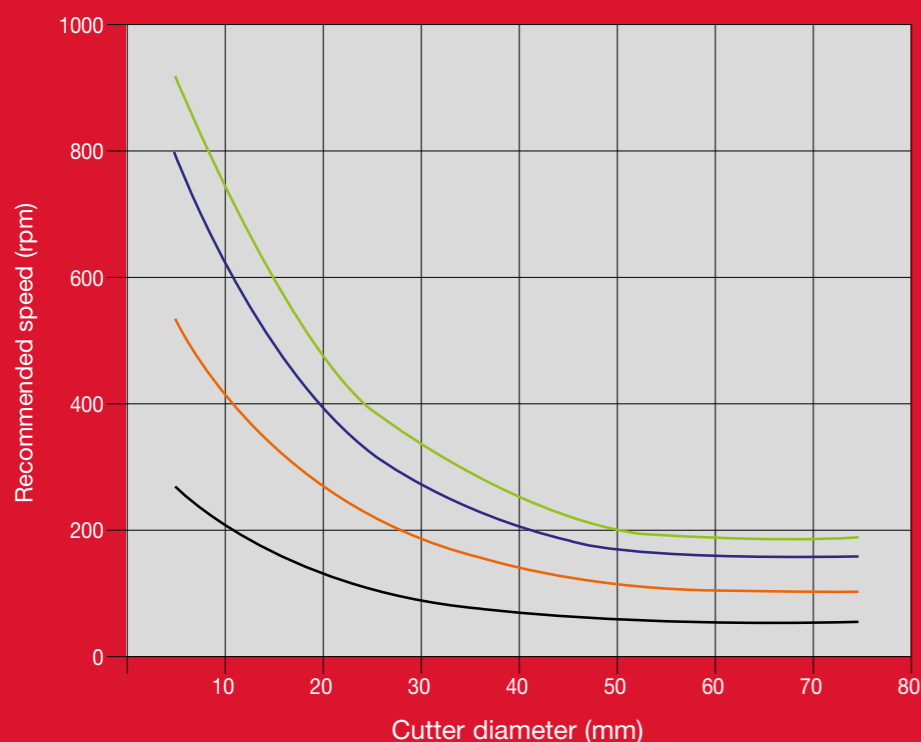

HSS annular cutters 30 mm

Thick walled HSS annular cutters for increased durability and life time. With standard 19 mm Weldon reception.

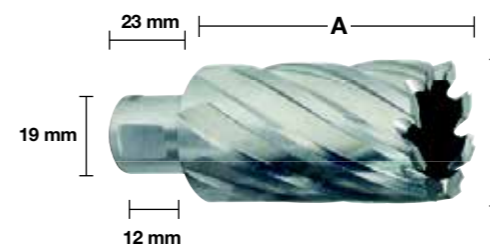

30 mm

Diameter (mm)	Total length (mm) A	Pack quantity	Min. order quantity	Article Number	EAN Code
12	30	1	1	4932371740	4002395344161
13	30	1	1	4932371741	4002395344178
14	30	1	1	4932343270	4002395315130
15	30	1	1	4932343271	4002395315147
16	30	1	1	4932343272	4002395315154
17	30	1	1	4932343273	4002395315161
18	30	1	1	4932343274	4002395315178
19	30	1	1	4932343275	4002395315185
20	30	1	1	4932343276	4002395315192
21	30	1	1	4932343277	4002395315208
22	30	1	1	4932343278	4002395315215
23	30	1	1	4932343279	4002395315222
24	30	1	1	4932343280	4002395315239
25	30	1	1	4932343281	4002395315246
26	30	1	1	4932343282	4002395315253
27	30	1	1	4932343283	4002395315260
28	30	1	1	4932343284	4002395315277
29	30	1	1	4932343285	4002395315284
30	30	1	1	4932343286	4002395315291
31	30	1	1	4932343287	4002395315307
32	30	1	1	4932343288	4002395315314
33	30	1	1	4932371742	4002395344185
34	30	1	1	4932371743	4002395344192
35	30	1	1	4932371744	4002395344208
36	30	1	1	4932371745	4002395344215
37	30	1	1	4932371746	4002395344222
38	30	1	1	4932371747	4002395344239
39	30	1	1	4932371748	4002395344246
40	30	1	1	4932371749	4002395344253
41	30	1	1	4932371750	4002395344260
42	30	1	1	4932371751	4002395344277
43	30	1	1	4932371752	4002395344284
44	30	1	1	4932371753	4002395344291
45	30	1	1	4932371754	4002395344307
46	30	1	1	4932371755	4002395344314
47	30	1	1	4932371756	4002395344321
48	30	1	1	4932371757	4002395344338
49	30	1	1	4932371758	4002395344345
50	30	1	1	4932371759	4002395344352

50 mm

Diameter (mm)	Total length (mm) A	Pack quantity	Min. order quantity	Article Number	EAN Code
14	50	1	1	4932343289	4002395315352
15	50	1	1	4932343290	4002395315369
16	50	1	1	4932343291	4002395315376
17	50	1	1	4932343292	4002395315383
18	50	1	1	4932343293	4002395315390
19	50	1	1	4932343294	4002395315406
20	50	1	1	4932343295	4002395315413
21	50	1	1	4932343296	4002395315420
22	50	1	1	4932343297	4002395315437
23	50	1	1	4932343298	4002395315444
24	50	1	1	4932343299	4002395315451
25	50	1	1	4932343300	4002395315468
26	50	1	1	4932343301	4002395315475
27	50	1	1	4932343302	4002395315482
28	50	1	1	4932343303	4002395315499
29	50	1	1	4932343304	4002395315505
30	50	1	1	4932343305	4002395315512
31	50	1	1	4932343306	4002395315529
32	50	1	1	4932343307	4002395315536
33	50	1	1	4932371760	4002395344369
34	50	1	1	4932371761	4002395344376
35	50	1	1	4932371762	4002395344383
36	50	1	1	4932371763	4002395344390
37	50	1	1	4932371764	4002395344406
38	50	1	1	4932371765	4002395344413
39	50	1	1	4932371766	4002395344420
40	50	1	1	4932371767	4002395344437
41	50	1	1	4932371768	4002395344444
42	50	1	1	4932371769	4002395344451
43	50	1	1	4932371770	4002395344468
44	50	1	1	4932371771	4002395344475
45	50	1	1	4932371772	4002395344482
46	50	1	1	4932371773	4002395344499
47	50	1	1	4932371774	4002395344505
48	50	1	1	4932371775	4002395344512
49	50	1	1	4932371776	4002395344529
50	50	1	1	4932371777	4002395344536

Description	Supplied in	Pack quantity	Min. order quantity	Article Number	EAN Code
Ejector pin for 30 mm cutters for all diameters		1	1	4932343308	4002395315321
Ejector pin for 50 mm cutters for all diameters		1	1	4932343309	4002395315543
Telescopic ejector pin for 30 mm cutters from 15mm		2	1	49590011	045242364039
Telescopic ejector pin for 50 mm cutters from 15mm		2	1	49590012	045242364046

HSS annular cutter set (6pc)

① 6 x HSS annular cutters: Ø 14 / 16 / 18 / 20 / 22 / 24 mm - 19 mm Weldon reception. 1 x ejector pin short series - 30 mm	Plastic case	6	1	4932372533	4002395345236
--	--------------	---	---	------------	---------------



MILWAUKEE® HOLESAW RANGE

If you're cutting or boring holes, look no further than our range of holesaws and the HOLEDOZER™ product line.



HOLE DOZER™

The MILWAUKEE® HOLE DOZER™ is the jobsite workhorse that provides unstoppable durability through the most demanding applications.

Multiple leverage points to remove material out of the holesaw for faster plug removal.

- Deepest access for thick plugs
- Higher access for thin material
- Minimises downtime between cuts
- New coating allows less friction and increases drilling speed

PLUG JACK™



A 3.5 teeth per inch tooth design with a positive 10° tooth angle provides the following benefits:

- Faster and more aggressive cut.
- Improved heat dispersion during cutting ensures that the teeth stay sharper for longer.
- Deeper curved gullets provide more efficient chip clearance preventing clogging and heat build up.
- Special shaped tooth angle has less tendency to snag on thinner materials.

This high quality holesaw range is the perfect solution for cutting all types of materials: - Steel up to 1000 N/mm² strength - Stainless steel and acid resistant steel - Non-ferrous metals - Cast iron - Aluminium - Wood - Medium density fibreboard (MDF) - Gypsum plasterboard - Sandwich materials - PVC.

HOLE DOZER™ bi-metal holesaws

Diameter (mm)	Ø (inch)	Max. cutting depth (mm)	Pack quantity	Min. order quantity	Article Number	EAN Code
14	9/16	41	1	1	49560002	045242271061
16	5/8	41	1	1	49560012	045242192922
17	11/16	41	1	1	49560014	045242193639
19	3/4	41	1	1	49560023	045242192632
20	25/32	41	1	1	49560024	045242271016
21	13/16	41	1	1	49560027	045242192649
22	7/8	41	1	1	49560032	045242192878
24	19/16	41	1	1	49560037	045242192885
25	1	41	1	1	49560043	045242192526
27	1 1/16	41	1	1	49560047	045242192892
29	1 1/8	41	1	1	49560052	045242192939
30	1 3/16	41	1	1	49560057	045242192946
32	1 1/4	41	1	1	49560062	045242192977
33	1 5/16	41	1	1	49560067	045242192984
35	1 3/8	41	1	1	49560072	045242192991
37	1 7/16	41	1	1	49560077	045242193028
38	1 1/2	41	1	1	49560082	045242193035
40	1 9/16	41	1	1	49560087	045242193042
41	1 5/8	41	1	1	49560092	045242193073
43	1 11/16	41	1	1	49560097	045242193080
44	1 3/4	41	1	1	49560102	045242193097
46	1 13/16	41	1	1	49560107	045242193127
48	1 7/8	41	1	1	49560112	045242193134
50	1 24/32	41	1	1	49560113	045242271023
51	2	41	1	1	49560117	045242193141
52	2 1/16	41	1	1	49560122	045242193172
54	2 1/8	41	1	1	49560127	045242193189
56	4/6	41	1	1	49560129	045242504664
57	2 1/4	41	1	1	49560132	045242193196
59	2 9/16	41	1	1	49560137	045242193226
60	2 3/8	41	1	1	49560142	045242193233
64	2 1/2	41	1	1	49560147	045242193240
65	2 9/16	41	1	1	49560153	045242193271
67	2 5/8	41	1	1	49560158	045242193288
68	2 11/16	41	1	1	49560159	045242271030
70	2 3/4	41	1	1	49560163	045242193295
73	2 7/8	41	1	1	49560167	045242193325
76	3	41	1	1	49560173	045242193332
79	3 1/8	41	1	1	49560177	045242193349
83	3 1/4	41	1	1	49560183	045242193370
86	3 3/8	41	1	1	49560187	045242193387
89	3 1/2	41	1	1	49560193	045242193394
92	3 5/8	41	1	1	49560197	045242193431
95	3 3/4	41	1	1	49560203	045242193448
98	3 7/8	41	1	1	49560207	045242193479
102	4	41	1	1	49560213	045242193486
105	4 1/8	41	1	1	49560217	045242193493
108	4 1/4	41	1	1	49560223	045242193523
111	4 3/8	41	1	1	49560227	045242193530
114	4 1/2	41	1	1	49560233	045242193547
117	4 5/8	41	1	1	49560239	045242587285
121	4 3/4	41	1	1	49560237	045242193578
127	5	41	1	1	49560243	045242193585
133	5 1/4	41	1	1	49560244	045242271078
140	5 1/2	41	1	1	49560247	045242193592
152	6	41	1	1	49560253	045242193622
160	6 5/16	38	1	1	4932399885	4002395365395
168	6 3/8	38	1	1	4932399886	4002395365401
177	6 31/32	38	1	1	4932399887	4002395365418
200	7 7/8	38	1	1	4932399888	4002395365425
210	8 9/32	38	1	1	4932399889	4002395365432



HOLE DOZER™ bi-metal holesaws - bulk packs

Diameter (mm)	Ø (inch)	Max. cutting depth (mm)	Pack quantity	Min. order quantity	Article Number	EAN Code
19	3/4	41	1	25	49565090	045242176199
20	25/32	41	1	25	49565091	045242528943
22	7/8	41	1	25	49565100	045242156375
25	1	41	1	25	49565110	045242156382
29	1 1/8	41	1	25	49565120	045242156399
30	1 3/16	41	1	25	49565125	045242243976
32	1 1/4	41	1	25	49565130	045242156412
35	1 3/8	41	1	25	49565140	045242156429
38	1 1/2	41	1	25	49565150	045242156436
41	1 5/8	41	1	25	49565152	045242176229
44	1 3/4	41	1	25	49565155	045242176267
51	2	41	1	25	49565160	045242156443
54	2 1/8	41	1	25	49565165	045242176366
57	2 1/4	41	1	25	49565167	045242176373
60	2 3/8	41	1	25	49565169	045242528950
64	2 1/2	41	1	25	49565170	045242156467
67	2 5/8	41	1	16	49565175	045242176380
68	2 11/16	41	1	16	49565178	045242528967
76	3	41	1	16	49565180	045242176397
89	3 1/2	41	1	9	49565190	045242176403
92	3 5/8	41	1	9	49565195	045242176410
102	4	41	1	9	49565200	045242176427
105	4 1/8	41	1	9	49565205	045242176434



HOLE DOZER™ bi-metal holesaws - sets

Description	Pack quantity	Min. order quantity	Article Number	EAN Code
Hole Dozer™ holesaw set (7pc)				
① 5 x holesaws: Ø 19, 22, 25, 29, 32 mm. Arbor for Ø 14 - 30 mm holesaws. Spacer and adaptor. 1/8" allen key	7	1	49224083	045242310760
Hole Dozer™ holesaw set (10pc)				
② 6 x holesaws: Ø 25, 32, 40, 54, 68, 76 mm. Arbor for Ø 14 - 30 mm holesaws. Arbor for Ø 32 - 152 mm holesaws. 2 x pilot drill bits. 1/8" allen key	10	1	49224201	045242348091
Hole Dozer™ holesaw set (14pc)				
③ 10 x holesaws: Ø 19, 22, 25, 29, 32, 35, 38, 44, 51, 57 mm. Arbor for Ø 14 - 30 mm holesaws. Arbor for Ø 32 - 152 mm holesaws. 2 x pilot drill bits. 1/8" allen key	14	1	49224152	045242271047
Hole Dozer™ holesaw set (17pc)				
④ 13 x holesaws: Ø 20, 22, 25, 32, 40, 44, 51, 57, 64, 65, 67, 68, 76 mm. Arbor for Ø 14 - 30 mm holesaws. Arbor for Ø 32 - 152 mm holesaws. 2 x pilot drill bits. 1/8" allen key	17	1	49224102	045242271054
Kit box for holesaws				
⑤ Arbor with pilot drill bit (4932479465). Arbor with pilot drill bit (4932479467). 2 x Pilot drill bits. 1/8" allen key (49960060)	4	1	4932430327	4002395379880
Hole Dozer™ PACKOUT™ holesaw set (12pc)				
⑥ 10 x holesaws: Ø 20, 25, 32, 35, 40, 44, 51, 54, 68, 76 mm. Arbor for Ø 14 - 30 mm holesaws. Arbor for Ø 32 - 152 mm holesaws. 1/4" allen key	12	1	4932472248	4058546338947
Hole Dozer™ Quik Lok™ holesaw set (9pc)				
⑦ 6 x holesaws: Ø 25, 32, 40, 54, 68, 76 mm. Quik Lok™ arbor inc. pilot drill. 1 x small adaptors, 2 x large adaptors, 3 x XL two pin adaptors. 1 x pilot drill bits, 1/8" hex key.	9	1	49224771	045242405244
Hole Dozer™ Quik Lok™ holesaw set (13pc)				
⑧ 10 x holesaws: Ø 19, 22, 25, 29, 32, 35, 38, 44, 51, 57 mm. Quik Lok™ arbor inc. pilot drill. 4 x small adaptors, 5 x large adaptors, 1 x XL two pin adaptors. 1 x pilot drill bit, 1/8" hex key.	13	1	49224772	045242405251



HOLE DOZER™ carbide holesaws

Up to 10x more life, high heat and wear resistance compared to Bi-Metal holesaws. 3 Tpi aggressive tooth geometry with large gullets for improved material removal. Offset teeth for less resistance. PLUG JACK™ slot geometry provides deep access to remove thick plugs and high leverage for thin materials. Application areas: metalworking (stainless steel, high alloy steels, aluminium) and composites (plastics, sandwich material, computer flooring, fibreglass, plastic coated wood boards, nail embedded wood).



Diameter (mm)	Ø (inch)	Max. cutting depth (mm)	Pack quantity	Min. order quantity	Article Number	EAN Code
19	3/4	41	1	1	49560702	045242503971
22	7/8	41	1	1	49560704	045242503995
25	1	41	1	1	49560707	045242504008
27	1 1/16	41	1	1	49560807	045242594764
29	1 1/8	41	1	1	49560708	045242504015
32	1 1/4	41	1	1	49560710	045242504022
33	1 3/16	41	1	1	49560711	045242630790
35	1 3/8	41	1	1	49560712	045242504039
38	1 1/2	41	1	1	49560713	045242504053
41	1 5/8	41	1	1	49560714	045242594771
44	1 3/4	41	1	1	49560717	045242504107
48	1 7/8	41	1	1	49560719	045242504114
51	2	41	1	1	49560720	045242504145
54	2 1/8	41	1	1	49560722	045242504152
57	2 1/4	41	1	1	49560724	045242504169
60	2 3/8	41	1	1	49560726	045242504176
64	2 1/2	41	1	1	49560727	045242504183
65	2 9/16	41	1	1	49560728	045242594788
67	2 5/8	41	1	1	49560729	045242504190
68	2 11/16	41	1	1	49560730	045242594795
70	2 3/4	41	1	1	49560731	045242504206
76	3	41	1	1	49560734	045242504220
79	3 1/8	41	1	1	49560735	045242603831
83	3 1/4	41	1	1	49560736	045242504237
86	3 3/8	41	1	1	49560737	045242594801
89	3 1/2	41	1	1	49560738	045242504244
92	3 5/8	41	1	1	49560739	045242504251
102	4	41	1	1	49560742	045242504275
108	4 1/4	41	1	1	49560744	045242504282
114	4 1/2	41	1	1	49560746	045242504299
121	4 3/4	41	1	1	49560847	045242594849
127	5	41	1	1	49560748	045242504305
140	5 1/2	41	1	1	49560848	045242594856
152	6	41	1	1	49560749	045242504312
Carbide Hole Dozer™ set (9pc)			9	1	49223079	045242533039

5 x carbide holesaws: Ø 22, 29, 35, 51, 64 mm. Arbor for Ø 14 - 30 mm (4932479465). Arbor for Ø 32 - 152 mm (4932479467). 2 x HSS-Cobalt pilot drill bits. 1/8" allen key



Bi-Metal contractor holesaws

Optimised variable 4-6 tooth geometry for faster cutting and universal use.
Bi-Metal teeth for best durability and increased wear resistance.
For universal use: steel, non ferrous metals, wood, drywall plasterboard, plastics.

Diameter (mm)	Ø (inch)	Max. cutting depth (mm)	Pack quantity	Min. order quantity	Article Number	EAN Code
14	9/16	38	1	1	4932464671	4058546226169
16	5/8	38	1	1	4932464672	4058546226176
19	3/4	38	1	1	4932464673	4058546226183
20	29/32	38	1	1	4932464674	4058546226190
21	13/16	38	1	1	4932464675	4058546226206
22	7/8	38	1	1	4932464676	4058546226213
24	15/16	38	1	1	4932464677	4058546226220
25	1	38	1	1	4932464678	4058546226237
27	1 1/16	38	1	1	4932464679	4058546226244
29	1 1/8	38	1	1	4932464680	4058546226251
30	1 1/16	38	1	1	4932464681	4058546226268
32	1 1/4	38	1	1	4932464682	4058546226275
35	1 3/8	38	1	1	4932464683	4058546226282
38	1 1/2	38	1	1	4932464684	4058546226299
40	1 9/16	38	1	1	4932464685	4058546226305
43	1 11/16	38	1	1	4932464686	4058546226312
44	1 3/4	38	1	1	4932464687	4058546226329
48	1 7/8	38	1	1	4932464688	4058546226336
51	2	38	1	1	4932464689	4058546226343
54	2 1/8	38	1	1	4932464690	4058546226350
56	5/8	38	1	1	4932464691	4058546226367
57	2 1/4	38	1	1	4932464692	4058546226374
60	2 3/8	38	1	1	4932464693	4058546226381
64	2 1/2	38	1	1	4932464694	4058546226398
65	2 9/16	38	1	1	4932464695	4058546226404
67	2 5/8	38	1	1	4932464696	4058546226411
68	2 11/16	38	1	1	4932464697	4058546226428
70	2 3/4	38	1	1	4932464698	4058546226435
73	2 7/8	38	1	1	4932464699	4058546226442
76	3	38	1	1	4932464700	4058546226459
79	3 1/8	38	1	1	4932464701	4058546226466
83	3 1/4	38	1	1	4932464702	4058546226473
89	3 1/2	38	1	1	4932464703	4058546226480
92	3 5/8	38	1	1	4932464704	4058546226497
98	3 7/8	38	1	1	4932464705	4058546226503
102	4	38	1	1	4932464706	4058546226510
105	4 1/8	38	1	1	4932464707	4058546226527
114	4 1/2	38	1	1	4932464708	4058546226534
121	4 3/4	38	1	1	4932464709	4058546226541
127	5	38	1	1	4932464710	4058546226558
152	6	38	1	1	4932464711	4058546226565



System accessories - Holesaws

Description	Fits holesaw Ø	Shank reception	Holesaw or core reception	Pack quantity	Min. order quantity	Article Number	EAN Code
① Arbor	14-30 mm	9.5 mm Hex	1/2" x 20	1	1	4932479465	4058546372590
② Arbor	Ø 32-210 mm	9.5 mm Hex	5/8" x 18	1	1	4932479466	4058546372606
③ Arbor	Ø 32-210 mm	11 mm Hex	5/8" x 18	1	1	4932479467	4058546372613
④ SDS-Plus arbor	Ø 14-30 mm	SDS-Plus	1/2" x 20	1	1	4932471694	4058546295936
⑤ SDS-Plus arbor	Ø 32-210 mm	SDS-Plus	5/8" x 18	1	1	4932471695	4058546295943
⑥ Extension - 300 mm long	-	9.5 mm Hex	-	1	1	4932479470	4058546372644
⑥ Extension - 305 mm long	-	7/16" Hex	-	1	1	4932479494	4058546372880
⑦ Pilot drill bit HSS-Ground Ø 6.35 mm x 89 mm length. Fits to all arbors	-	-	-	1	1	4932479468	4058546372620
⑦ Pilot drill long HSS-Ground Ø 6.35 mm x 100 mm length. Fits to all arbors	-	-	-	1	1	4932479469	4058546372637
⑧ Pilot drill bit HSS-Cobalt Ø 6 mm x 89 mm length. Fits to all arbors	-	-	-	1	1	4932499257	4058546564216
⑨ Hex key 1/8" for all arbors	-	-	-	1	1	43960270	045242825134
⑩ Grub screw for arbors and extensions	-	-	-	1	1	06832712	4002395874354



Bi-Metal contractor holesaw - sets

Optimised variable 4/6 tooth geometry for faster cutting and universal use.
Bi-Metal teeth for best durability and increased wear resistance.
For universal use: steel, non-ferrous metals, wood, drywall plasterboard, plastics.

Description	Pack quantity	Min. order quantity	Article Number	EAN Code
Bi-metal contractor holesaw set (10pc)				
① 6 x Holesaws: Ø 25, 32, 40, 54, 68, 76 mm. 1 x arbor for Ø 14 - 30 mm. 1 x arbor for Ø 32 - 152 mm. 2 x pilot drill bits. Allen key	10	1	4932464719	4058546226640
Bi-Metal contractor holesaw set (14pc)				
② 10 x Holesaws: Ø 19, 22, 25, 29, 32, 35, 38, 44, 51, 57 mm. 1 x arbor for Ø 14 - 30 mm. 1 x arbor for Ø 32 - 152 mm. 2 x pilot drill bits. Allen key	14	1	4932464720	4058546226657



QUIK-LOK™

UNIVERSAL FIT. UNLIMITED POSSIBILITIES.

Say goodbye to the clutter of multiple arbors. The MILWAUKEE® QUIK-LOK™ Arbor fits every Holesaw from 14 – 210 mm, across most brands. With just one arbor and three universal adaptors, you can drill with confidence – no matter the job or application.

Available in both 9.5 mm and 7/16" hex, it's built for true versatility. Need to enlarge a hole? QUIK-LOK™ makes that easy too with the new hole enlargement adaptor (from 32mm – 210 mm). Simplify your kit. Maximise your capability.



Quick and easy change of holesaw

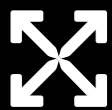

Universal Arbors fit most brands of holesaw



Fits every holesaw from 14 – 210mm



Quik-Lok Hole Enlargement Adaptor ref 4932500553

System Accessories - Holesaws QUIK-LOK

Description	Fits holesaw	Shank reception	Holesaw or core reception	Pack quantity	Min. order quantity	Article Number	EAN Code
QUIK-LOK™ arbor 3/16" 9.5mm Hex. Supplied with pilot drill and 2 x S adaptors	Ø 14-30 mm	9.5 mm Hex	1/2" x 20	1	1	4932500548	4058546618506
QUIK-LOK™ arbor 1/8" 11mm Hex. Supplied with pilot drill, 1 x S adaptor and 1 x XL adaptor	Ø 32-210 mm	11 mm Hex	5/8" x 18	1	1	4932500549	4058546618513
QUIK-LOK™ adaptor S for holesaws Ø14-30mm	Ø 14-30 mm	1/2" x 20	1/2" x 20	5	1	4932500550	4058546618520
QUIK-LOK™ adaptor L for holesaws Ø32-51mm	Ø 32-51 mm	5/8" x 18	5/8" x 18	5	1	4932500551	4058546618537
QUIK-LOK™ pin adaptor XL for holesaws Ø32-210mm	Ø 32-210 mm	5/8" x 18	5/8" x 18	2	1	4932500552	4058546618544
QUIK-LOK™ hole enlargement adaptor	Ø 32-210 mm	5/8" x 18	5/8" x 18	1	1	4932500553	4058546618551
Hole Dozer™ Quik Lok™ holesaw set (9pc)							
6 x holesaws: Ø 25, 32, 40, 54, 68, 76 mm. Quik Lok™ arbor inc. pilot drill. 1 x small adaptors, 2 x large adaptors, 3 x XL two pin adaptors. 1 x pilot drill bits, 1/8" hex key.				9	1	49224771	045242405244
Hole Dozer™ Quik Lok™ holesaw set (13pc)							
10 x holesaws: Ø 19, 22, 25, 29, 32, 35, 38, 44, 51, 57 mm. Quik Lok™ arbor inc. pilot drill. 4 x small adaptors, 5 x large adaptors, 1 x XL two pin adaptors. 1 x pilot drill bit, 1/8" hex key.				13	1	49224772	045242405251



Adjustable hole cutter

For cutting large diameter holes for air conditioning pipes, fans, downlights and ceiling speakers. Dust collection shroud for 100% dust free work when overhead drilling. Diameter is adjustable from 51 mm to 178 mm in 6.4 mm steps. Laser marked preset diameters at 51 - 178 mm. Suitable for use on drywall (max. 25 mm) and ceiling tile. Not suitable for OSB wood boards.



Description	Pack quantity	Min. order quantity	Article Number	EAN Code
Adjustable hole cutter				
① Pilot drill, 2 blades, QL arbor and dust collection shroud	5	1	49560260	045242350261
② QL arbor with 1/2" Hex reception. 75 mm long	1	1	4932479553	4058546373474
Replacement blade and pilot drill set (4pc)				
③ 1 x pilot drill bit, 2 x blades and 1 x allen key	4	1	49560290	045242346370

HOLE DOZER™ holesaws: Recommended cutting speed in RPM

Diameter (mm)	Ø (inch)	Metal	Cast Iron	Stainless steel	Non ferrous metal	Aluminium	Wood	MDF
14	9/16	580	400	300	790	900	1500	750
16	5/8	550	365	275	730	825	1500	750
17	11/16	500	330	250	665	750	1500	750
19	3/4	460	300	230	600	690	1500	750
20	29/32	425	280	210	560	635	1500	750
21	13/16	425	280	210	560	635	1500	750
22	7/8	390	260	195	520	585	1500	750
23	29/32	370	250	185	500	550	1500	750
25	1	350	235	175	470	525	1500	750
27	1 1/16	325	215	160	435	480	1400	700
29	1 1/8	300	200	150	400	450	1400	700
30	1 3/16	285	190	145	380	425	1400	700
32	1 1/4	275	180	140	380	410	1400	700
33	1 5/16	260	175	135	345	390	1400	700
35	1 3/8	250	165	125	330	375	1400	700
37	1 7/16	240	160	120	315	360	1400	700
38	1 1/2	230	150	115	300	345	1400	700
40	1 9/16	220	145	110	290	330	1200	600
41	1 5/8	210	140	105	280	315	1200	600
43	1 11/16	205	135	100	270	305	1200	600
44	1 3/4	195	130	95	260	295	1200	600
46	1 13/16	190	125	95	250	285	1200	600
48	1 7/8	180	120	90	240	270	1200	600
50	1 24/25	175	120	85	230	260	1200	600
51	2	170	115	85	230	255	1200	600
52	2 1/16	165	110	80	220	245	1200	600
54	2 1/8	150	100	75	200	225	1000	500
56	4/6	145	100	75	195	225	1000	500
57	2 1/4	145	100	75	195	225	1000	500
59	2 3/16	145	100	75	195	225	1000	500
60	2 3/8	140	95	70	190	220	1000	500
63	2 31/64	135	90	65	180	205	900	450
64	2 1/2	135	90	65	180	205	900	450
65	2 9/16	130	85	65	175	200	800	400
68	2 11/16	125	80	60	160	185	800	400
73	2 7/8	120	80	60	160	180	800	400
76	3	115	75	55	150	170	700	350
79	3 1/8	110	70	55	140	165	700	350
83	3 1/4	105	50	40	140	155	700	350
86	3 3/8	100	45	30	130	150	500	250
89	3 1/2	95	45	30	130	145	500	250
92	3 5/8	95	60	45	120	140	500	250
95	3 3/4	90	60	45	120	135	500	250
98	3 7/8	90	60	45	120	135	500	250
102	4	85	55	40	110	130	400	200
105	4 1/8	80	55	40	110	120	400	200
111	4 3/8	80	50	40	100	120	300	150
114	4 1/2	75	50	35	100	105	300	150
121	4 3/4	75	50	35	95	95	300	150
127	5	65	45	30	90	90	200	100
133	5 1/4	60	40	25	85	85	200	100
140	5 1/2	60	40	25	85	85	200	100
146	5 3/4	55	35	25	75	75	200	100
152	6	55	35	25	75	75	200	100
160	6 5/16	50	30	25	60	60	150	75
168	6 5/8	50	30	25	55	55	150	75
177	6 31/32	45	25	25	55	55	150	75
200	7 7/8	40	25	25	50	50	100	50
210	8 9/32	40	20	25	50	50	100	50
	-	Cutting oil	Dry	Cutting oil	Cutting oil	Turpentine	Dry	Dry



Speed kills!

Operating at higher speeds than those recommended will shorten the life of the holesaw and produce very inefficient cutting.



Feed Pressure:

Variables in material, work configuration should be considered. Apply sufficient feed pressure to aid good chip re-removal. Reduce the pressure when the holesaw becomes hot or if the teeth start to clog with material. Insufficient feed pressure will dull tooth points prematurely but too much pressure can totally destroy teeth.



Cooling Lubricant:

Cutting oil serves two purposes when sawing in metals. It cools the saw and the work piece. It reduces heat and abrasion which can shorten cutting life. It also aids re-moving swarf from the cutting surface. Using a cooling lubricant will extend the life of your holesaw by 500%.

T.C.T. Stainless steel holesaws

Carbide tooth technology provides for best performance, speed and 10x more lifetime than standard bi-metal holesaws. Teeth can also be resharpened.

Extra deep 25 mm cutting depth for drilling in sheet material and pipes.

One solid piece holesaw design reduces wobble and vibration for accurate drilling.

Safety stop collar prevents over drilling for best safety.

Ejector spring helps eject the slug, prevents jamming and saves time.

With 3-flat secure grip shank reception to prevent the holesaw slipping in the chuck and to ensure maximum torque transmission. Diameters 16-76 mm with 10 mm and >80 mm with 13 mm 3-flat shank reception.

Replaceable pilot drill and spring.

Use a cooling lubricant to extend the life of the holesaw. For metals use cutting oil, aluminium turpentine, plastics water and for cast iron drill dry.

Suitable for drilling steel (<1200 N/mm²) up to 4 mm, stainless steel up to 2 mm, aluminium, zink, cast iron, copper, fibreglass and PVC.

Diameter (mm)	Max. cutting depth (mm)	Pack quantity	Min. order quantity	Article Number	EAN Code		
16	25	1	1	4932479033	4058546363239		
18	25	1	1	4932479034	4058546368289		
19	25	1	1	4932479035	4058546368296		
20	25	1	1	4932479036	4058546368302		
22	25	1	1	4932479037	4058546368319		
24	25	1	1	4932479038	4058546368326		
25	25	1	1	4932479039	4058546368333		
29	25	1	1	4932479040	4058546368340		
30	25	1	1	4932479041	4058546368357		
32	25	1	1	4932479042	4058546368364		
35	25	1	1	4932479043	4058546368371		
38	25	1	1	4932479044	4058546368388		
40	25	1	1	4932479045	4058546368395		
44	25	1	1	4932479046	4058546368401		
45	25	1	1	4932479047	4058546368418		
50	25	1	1	4932479048	4058546368425		
51	25	1	1	4932479049	4058546368432		
54	25	1	1	4932479050	4058546368449		
60	25	1	1	4932479051	4058546368456		
64	25	1	1	4932479052	4058546368463		
70	25	1	1	4932479053	4058546368470		
76	25	1	1	4932479054	4058546368487		
80	25	1	1	4932479055	4058546368494		
85	25	1	1	4932479056	4058546368500		
102	25	1	1	4932479057	4058546368517		
T.C.T. holesaw set (4pc)				4	1	4932479058	4058546368524
4 x T.C.T. holesaws: Ø16, 20, 25, 32 mm. 1/8" allen key							
Pilot drill bit (Ø6 x 76mm) including spring for T.C.T. holesaws		1	1	4932479059	4058546368531		
Spring for T.C.T. holesaw pilot drill		3	1	4932479060	4058546368548		
Grub screw M6 for T.C.T. holesaw arbor		3	1	4932479061	4058546368555		



Holesaw Ø mm	Speed - RPM	
	Steel < 800N/mm ²	Stainless Steel / Steel < 1200N/mm ²
16	995	696
20	796	557
25	637	446
30	531	371
35	455	318
40	398	279
45	354	248
50	318	223
55	289	203
60	265	186
65	245	171
70	227	159
75	212	149
80	199	139
85	187	131
90	177	124
95	168	117
100	159	111

BIG HAWG™ multi material holesaws

BIG HAWG™ multi material holesaws are ideal for electricians, carpenters, kitchen fitters & all related heating, ventilation and plumbing trades.

Designed for use in a wide variety of materials:

Bricks* - suitable for both solid bricks and bricks with cavities.

Aerated concrete blocks*, lightweight aggregate blocks and breeze blocks.

Soft density lime-sandstone building blocks up to hardness of 30 N/mm².

Softwoods, chipboard, plywood, medium density fibreboard (MDF).

Plastics and plastic coated board (Contiboard).

* Not suitable for use in hard materials such as concrete, granite, medium to hard density lime-sandstone block, natural stone and hard brick over 30 N/mm² hardness.



Diameter (mm)	Max. cutting depth (mm)	No. of teeth	Pack quantity	Min. order quantity	Article Number	EAN Code
25	60	2	1	1	4932464921	4058546228668
30	60	2	1	1	4932464922	4058546228675
35	60	2	1	1	4932464923	4058546228682
44	60	2	1	1	4932464924	4058546228699
51	60	3	1	1	4932464925	4058546228705
54	60	3	1	1	4932464926	4058546228712
57	60	3	1	1	4932464927	4058546228729
65	60	3	1	1	4932464928	4058546228736
68	60	3	1	1	4932464929	4058546228743
70	60	3	1	1	4932464930	4058546228750
76	60	3	1	1	4932464931	4058546228767
82	60	3	1	1	4932464932	4058546228774
92	60	3	1	1	4932464933	4058546228781
102	60	3	1	1	4932464934	4058546228798
108	60	3	1	1	4932464935	4058546228804
117	60	3	1	1	4932464936	4058546228811
133	60	3	1	1	4932464937	4058546228828
159	60	3	1	1	4932464938	4058546228835



BIG HAWG™ multi material holesaws - set

Description	Pack quantity	Min. order quantity	Article Number	EAN Code
BIG HAWG™ multi material set (10 pc)				
6 x holesaws: Ø 35, 44, 51, 57, 68, 76 mm. 1 x arbor with pilot drill. 2 x pilot drill. 1 x diamond file. Allen key	10	1	4932464939	4058546228842



BIG HAWG™ multi material - system accessories

Description	Pack quantity	Min. order quantity	Article Number	EAN Code
① BIG HAWG™ multi material pilot drill	1	1	4932464940	4058546228859
② BIG HAWG™ 7/16" multi material arbor with pilot drill	1	1	4932464941	4058546228866
③ Pilot drill flat bit 3/8" for wood only	1	1	48271401	045242121397



HCS holesaws

Optimised 5 Tpi tooth geometry for clean cuts in soft materials.
For use in plastics and drywall plasterboard.

Diameter (mm)	Max. cutting depth (mm)	Pack quantity	Min. order quantity	Article Number	EAN Code
121	96	1	1	4932472076	4058546324728
127	96	1	1	4932472077	4058546324735
133	96	1	1	4932472078	4058546324742
138	96	1	1	4932472079	4058546324759
150	96	1	1	4932472080	4058546324766
168	96	1	1	4932472081	4058546324773
172	96	1	1	4932472082	4058546324780
177	96	1	1	4932472083	4058546324797
186	96	1	1	4932472084	4058546324803
210	96	1	1	4932472085	4058546324810
212	96	1	1	4932472086	4058546324827
226	96	1	1	4932472087	4058546324834



System accessories - HCS holesaws

System accessories to be used with HCS holesaws.

1. Arbor with pilot drill
2. Pilot drill

Description	Pack quantity	Min. order quantity	Article Number	EAN Code
① HCS holesaws arbor with pilot drill	1	1	4932472088	4058546324841
② HCS holesaw pilot drill Ø6.35 and 150 mm length	1	1	4932472089	4058546324858



SHOCKWAVE™ IMPACT DUTY holesaws

Diameter (mm)	Pack quantity	Min. order quantity	Article Number	EAN Code
19	1	1	4932501132	4058546624347
22	1	1	4932501133	4058546624354
25	1	1	4932501134	4058546624361
① 29	1	1	4932501135	4058546624378
32	1	1	4932501136	4058546624385
35	1	1	4932501137	4058546624392
38	1	1	4932501138	4058546624408
② SHOCKWAVE™ IMPACT DUTY holesaw set (3pc) Ø 22 / 29 / 35 mm	3	1	4932501139	4058546624415
Ejection spring and grub screw	1	1	4932430466	4002395381272
Pilot drill bit with arbor	1	1	4932430477	4002395381388



SHOCKWAVE™
IMPACT DUTY

APPLICATION AREAS

CERAMIC TILES

- All types hard and soft:
Porcelain / Gres / Granite / Quarry /
Terrazzo / Artificial stone / Terracota /
Agglomerate / Glazed

CAST IRON

FIBREGLASS / GRP

- (Glass reinforced plastic) / Perspex

HOW TO USE:

1. Screw the grinder adaptor M14 to the holesaw and tighten firmly with a spanner. Then apply the spindle lock on the angle grinder and fit the adaptor directly onto the spindle; tighten firmly with a spanner.
2. If the tile is not fitted to a wall or floor ensure it is secured firmly with a clamp.
3. Switch on the tool to full speed. Slowly approach the tile with the drill bit at a 20-30° angle with light pressure to avoid skating on the tile. Once the drill bit starts to cut into the tile and forms a groove, gradually raise the drill so that it is horizontal (90°) with the tile.
4. Apply light pressure and an oscillating circular motion during cutting to maximise tool life.
5. When cutting material thicker than 10 mm, to optimise life and speed of cut, lift the drill/hole saw out of the hole every 5 seconds and allow it to rotate in the air to cool before continuing with the cut.

M14 DIAMOND DRY TILE DRILL BIT



Diamond grit drills and holesaws are designed for cutting holes in extremely hard materials such as porcelain/gres/quarry tiles, cast iron or fibreglass. These bits & holesaws guarantee superior life and fast cutting even in the hardest of materials. Can be used either on angle grinders with relevant adaptor or with a drill driver.

No water cooling necessary, 100% dry use.

Clean holes: Drills clean, precise holes without any perimeter scratches.

Superior lifetime and durability due to the high grade diamond bond and the tough alloy body which resists bending under stress.

Easy slug removal due to the multiple access slots.

M14 diamond tile drill bit

Diameter (mm)	Reception	Pack quantity	Min. order quantity	Article Number	EAN Code
5	M14	1	1	4932471758	4058546296575
6	M14	1	1	4932471759	4058546296582
8	M14	1	1	4932471760	4058546296599
10	M14	1	1	4932471761	4058546296605
12	M14	1	1	4932471762	4058546296612
14	M14	1	1	4932471763	4058546296629
16	M14	1	1	4932471764	4058546296636
18	M14	1	1	4932478276	4058546344535
20	M14	1	1	4932478277	4058546344542
22	M14	1	1	4932498354	4058546522230
25	M14	1	1	4932478278	4058546344559
30	M14	1	1	4932498355	4058546522247
32	M14	1	1	4932478279	4058546344566
35	M14	1	1	4932478280	4058546344573
38	M14	1	1	4932498356	4058546522254
40	M14	1	1	4932478281	4058546344580
44	M14	1	1	4932478282	4058546344597
51	M14	1	1	4932478283	4058546344603
54	M14	1	1	4932498357	4058546522261
55	M14	1	1	4932478284	4058546344610
57	M14	1	1	4932498358	4058546522278
60	M14	1	1	4932498359	4058546522285
64	M14	1	1	4932498360	4058546522292
65	M14	1	1	4932498361	4058546522308
68	M14	1	1	4932478285	4058546344627
73	M14	1	1	4932498362	4058546522315
75	M14	1	1	4932478286	4058546344634
76	M14	1	1	4932498363	4058546522322
83	M14	1	1	4932498364	4058546522339
102	M14	1	1	4932478287	4058546344641

① DIAMOND MAX™ diamond drill bit set (4pc)
Ø 6, 8, 10, 14 mm

② DIAMOND MAX™ diamond drill bit set (3pc)
Ø6 mm

③ DIAMOND MAX™ diamond drill bit set (3pc)
Ø8 mm

Description	Tool reception	Shank reception	Pack quantity	Min. order quantity	Article Number	EAN Code
Adaptor to fit M14 diamond drills to Milwaukee spot polisher	M9 x 0.75	M14	1	1	4932472090	4058546324865
Adaptor to fit M14 diamond drills to Milwaukee die grinder	M16 x 1.0	M14	1	1	4932472265	4058546339111

M14 diamond router bit

For milling and modelling applications in different materials e.g. porcelain tiles, granite, natural stone, marble, engineering bricks, roof tiles and concrete.
For chamfering all the mentioned materials.
For expanding existing holes.

Description	Diameter (mm)	Working length (mm)	Pack quantity	Min. order quantity	Article Number	EAN Code
M14 diamond router bit	20	35	1	1	4932479078	4058546368722

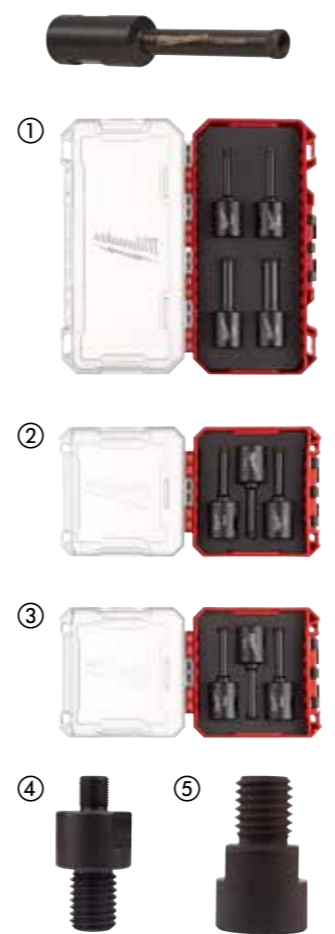

M14 diamond cup wheel

Optimal for all types of repair work in confined spaces.
For removing and levelling tile adhesive when replacing broken tiles.
For grinding different materials e.g. granite, stone, porcelain tiles, ceramic tiles, concrete, screed and removing adhesives.
M14 thread: To fit directly onto an angle grinder.
Lifetime: To ensure long lifetime, we use high grade diamond for fast grinding and a superior bond matrix to give best durability.

Description	Diameter (mm)	Cup wheel height (mm)	Segment height (mm)	Pack quantity	Min. order quantity	Article Number	EAN Code
M14 diamond cup wheel	50	27	2	1	1	4932479079	4058546368739



APPLICATION AREAS

CERAMIC TILES

- All types hard and soft: Porcelain / Gres / Granite / Quarry / Terrazzo / Artificial stone / Terracota / Agglomerate / Glazed

CAST IRON

FIBREGLASS / GRP

- (Glass reinforced plastic) / Perspex

1/4" WET TILE DRILL BITS

Diamond grit drills and holesaws are designed for cutting holes in extremely hard materials such as porcelain/gres/quarry tiles, cast iron or fibreglass. These bits & holesaws guarantee superior life and fast cutting even in the hardest of materials. Can be used either on angle grinders with relevant adaptor or with a drill driver.

Minimal water cooling: A continuous flow of water is required to cool the bits & holesaw during cutting.

Simply dip them in water before starting the cut and every 3 seconds during cutting for optimal performance.

Clean holes: Drills clean, precise holes without any perimeter scratches.

Superior lifetime and durability due to the high grade diamond bond and the tough alloy body which resists bending under stress.

Easy slug removal due to the multiple access slots.



DIAMOND MAX™ 1/4" WET drill bits

①	Diameter (mm)	Reception	Pack quantity	Min. order quantity	Article Number	EAN Code
5	5	1/4" Hex	1	1	4932498341	4058546522100
6	6	1/4" Hex	1	1	4932498342	4058546522117
8	8	1/4" Hex	1	1	4932498343	4058546522124
10	10	1/4" Hex	1	1	4932498344	4058546522131
12	12	1/4" Hex	1	1	4932498345	4058546522148
14	14	1/4" Hex	1	1	4932498346	4058546522155
16	16	1/4" Hex	1	1	4932498347	4058546522162
20	20	1/4" Hex	1	1	4932498348	4058546522179
22	22	1/4" Hex	1	1	4932498349	4058546522186
25	25	1/4" Hex	1	1	4932498350	4058546522193
29	29	1/4" Hex	1	1	4932498351	4058546522209
32	32	1/4" Hex	1	1	4932498352	4058546522216
35	35	1/4" Hex	1	1	4932498353	4058546522223

DIAMOND MAX™ diamond drill bit set (3pc)	3	1	4932498368	4058546522377
Ø 6, 8, 10 mm				

DIAMOND MAX™ diamond drill bit set (5pc)	5	1	4932498299	4058546521684
Ø 6 (2x), 8 (2x), 10 mm				

DIAMOND MAX™ diamond drill bit set (5pc)	5	1	4932498300	4058546521691
Ø 6 mm (5x)				

DIAMOND MAX™ diamond drill bit set (5pc)	5	1	4932498301	4058546521707
Ø 8 mm (5x)				

②	Diameter (mm)	Reception	Pack quantity	Min. order quantity	Article Number	EAN Code
22	22	1/2" x 20	1	1	49565605	045242308439
29	29	1/2" x 20	1	1	49565615	045242308446
32	32	5/8" x 18	1	1	4932500114	4058546572785
35	35	5/8" x 18	1	1	4932500115	4058546572792
38	38	5/8" x 18	1	1	4932500116	4058546572808
44	44	5/8" x 18	1	1	4932500117	4058546572815
51	51	5/8" x 18	1	1	4932500118	4058546572822
64	64	5/8" x 18	1	1	4932500119	4058546572839
68	68	5/8" x 18	1	1	4932500120	4058546572846

Description	Fits holesaw Ⓜ	Shank reception	Holesaw or core reception	Pack quantity	Min. order quantity	Article Number	EAN Code
Arbor	14-30 mm	9.5 mm Hex	1/2" x 20	1	1	4932479465	4058546372590
Arbor	Ø 32-210 mm	9.5 mm Hex	5/8" x 18	1	1	4932479466	4058546372606
Grinder adaptor	Ø 22-29mm	M14	1/2" x 20	1	1	4932430464	4002395381258
Grinder adaptor	Ø 32-68mm	M14	5/8" x 18	1	1	4932430465	4002395381265

Holesaw drilling guide

Constant water supply significantly increases the drill bit lifetime. Drilling guide provides a secure drilling into the material without slipping around and damaging the surface. Easy fixing and removal from surfaces due to vacuum fixing.

Description	Pack quantity	Min. order quantity	Article Number	EAN Code
Drilling guide for drills / holesaws Ø 19 - 68 mm	1	1	4932352332	4002395369911



Wet Diamond Drilling Cores

- ① Standard 1/4" UNC reception
- ② Stamping of diameter and type on the core reception for longterm visibility
- ③ Laser welded segments guarantee against break off
- ③ 10 mm segment height for superior lifetime



THIN KERF Wet diamond drilling cores

Cordless optimised diamond segments designed especially for MXFuel tool. Optimised for corded diamond drills up to 2200 Watt. 10 mm laser welded segments for superior lifetime. Standard 1/2" G reception on smaller diameters & standard 1 1/4" UNC reception on bigger diameters.

Diame-ter (mm)	Description	Fits DD3 - 152	Fits MXF DCD 150	Core reception	Working length (mm) B	Total length (mm) A	Pack quantity	Min. order quantity	Article Number	EAN Code
12	WCHP-TK 12 mm	✓	✓	1/2" G	200	270	1	1	4932472167	4058546325633
14	WCHP-TK 14 mm	✓	✓	1/2" G	300	370	1	1	4932472168	4058546325640
16	WCHP-TK 16 mm	✓	✓	1/2" G	300	370	1	1	4932472169	4058546325657
18	WCHP-TK 18 mm	✓	✓	1/2" G	300	370	1	1	4932472170	4058546325664
20	WCHP-TK 20 mm	✓	✓	1/2" G	300	370	1	1	4932472171	4058546325671
22	WCHP-TK 22 mm	✓	✓	1/2" G	300	370	1	1	4932472172	4058546325688
24	WCHP-TK 24 mm	✓	✓	1/2" G	300	370	1	1	4932472173	4058546325695
25	WCHP-TK 25 mm	✓	✓	1/2" G	300	370	1	1	4932472174	4058546325701
28	WCHP-TK 28 mm	✓	✓	1/2" G	300	370	1	1	4932472175	4058546325718
30	WCHP-TK 30 mm	✓	✓	1/2" G	300	370	1	1	4932472176	4058546325725
32	WCHP-TK 32 mm	✓	✓	1/2" G	300	370	1	1	4932472177	4058546325732
35	WCHP-TK 35 mm	✓	✓	1/2" G	300	370	1	1	4932472178	4058546325749
40	WCHP-TK 40 mm	✓	✓	1/2" G	300	370	1	1	4932472180	4058546325763
46	WCHP-TK 46 mm	✓	✓	1 1/4" UNC	450	525	1	1	4932478953	4058546325855
51	WCHP-TK 51 mm	✓	✓	1 1/4" UNC	450	525	1	1	4932472184	4058546325800
56	WCHP-TK 56 mm	✓	✓	1 1/4" UNC	450	525	1	1	4932472185	4058546325817
61	WCHP-TK 61 mm	✓	✓	1 1/4" UNC	450	525	1	1	4932472186	4058546325824
66	WCHP-TK 66 mm	✓	✓	1 1/4" UNC	450	525	1	1	4932472187	4058546325831
68	WCHP-TK 68 mm	✓	✓	1 1/4" UNC	450	525	1	1	4932478954	4058546325862
71	WCHP-TK 71 mm	✓	✓	1 1/4" UNC	450	525	1	1	4932472188	4058546325848
76	WCHP-TK 76 mm	✓	✓	1 1/4" UNC	450	525	1	1	4932472189	4058546325855
81	WCHP-TK 81 mm	✓	✓	1 1/4" UNC	450	525	1	1	4932472190	4058546325862
86	WCHP-TK 86 mm	✓	✓	1 1/4" UNC	450	525	1	1	4932472191	4058546325879
91	WCHP-TK 91 mm	✓	✓	1 1/4" UNC	450	525	1	1	4932472192	4058546325886
101	WCHP-TK 101 mm	✓	✓	1 1/4" UNC	450	525	1	1	4932472193	4058546325893
105	WCHP-TK 105 mm	✓	✓	1 1/4" UNC	450	525	1	1	4932472194	4058546325909
111	WCHP-TK 111 mm	✓	✓	1 1/4" UNC	450	525	1	1	4932472195	4058546325916
121	WCHP-TK 121 mm	✓	✓	1 1/4" UNC	450	525	1	1	4932472196	4058546325923
126	WCHP-TK 126 mm	✓	✓	1 1/4" UNC	450	525	1	1	4932478955	4058546325939
130	WCHP-TK 130 mm	✓	✓	1 1/4" UNC	450	525	1	1	4932472197	4058546325930
140	WCHP-TK 140 mm	✓	✓	1 1/4" UNC	450	525	1	1	4932472198	4058546325947
150	WCHP-TK 150 mm	✓	✓	1 1/4" UNC	450	525	1	1	4932472199	4058546325954



Wet diamond drilling cores

	Fits DD3-152	Fits DCM2-250C & DCM2-350C	Core	Working length (mm) B	Total length (mm) A	Pack quantity	Min. order quantity	Article Number	EAN Code
52	WCHP 52	✓	1 1/4" UNC	450	525	1	1	4932399707	4002395363582
62	WCHP 62	✓	1 1/4" UNC	450	525	1	1	4932399708	4002395363599
72	WCHP 72	✓	1 1/4" UNC	450	525	1	1	4932399709	4002395363605
82	WCHP 82	✓	1 1/4" UNC	450	525	1	1	4932399710	4002395363612
92	WCHP 92	✓	1 1/4" UNC	450	525	1	1	4932399711	4002395363629
102	WCHP 102	✓	1 1/4" UNC	450	525	1	1	4932399712	4002395363636
112	WCHP 112	✓	1 1/4" UNC	450	525	1	1	4932399713	4002395363643
122	WCHP 122	✓	1 1/4" UNC	450	525	1	1	4932399714	4002395363650
132	WCHP 132	✓	1 1/4" UNC	450	525	1	1	4932399715	4002395363667
152	WCHP 152	✓	1 1/4" UNC	450	525	1	1	4932399716	4002395363674
162	WCHP 162	✓	1 1/4" UNC	450	525	1	1	4932399717	4002395363681
172	WCHP 172	✓	1 1/4" UNC	450	525	1	1	4932352052	4002395367092
182	WCHP 182	✓	1 1/4" UNC	450	525	1	1	4932399718	4002395363698
202	WCHP 202	✓	1 1/4" UNC	450	525	1	1	4932399719	4002395363704
225	WCHP 225	✓	1 1/4" UNC	450	525	1	1	4932399720	4002395363711
250	WCHP 250	✓	1 1/4" UNC	450	525	1	1	4932399721	4002395363728
300	WCHP 300	✓	1 1/4" UNC	450	525	1	1	4932399722	4002395363735
350	WCHP 350	✓	1 1/4" UNC	450	525	1	1	4932399723	4002395363742

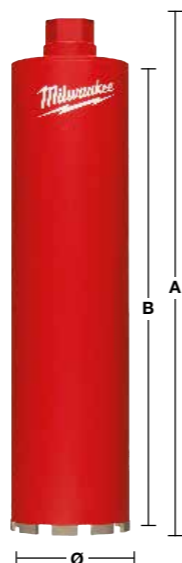

Dry diamond cores with dust extraction - DCHXL

10 mm high, laser welded segments for longer life.
Use with the machine set to rotary only, not suitable for hammer action.

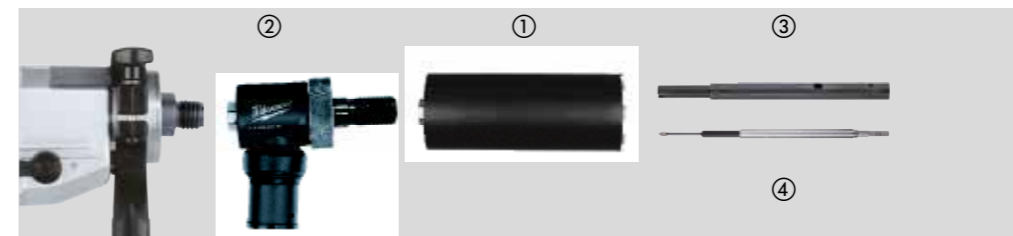

Material	DCHXL	Material	DCHXL
Aerated/breeze concrete blocks	◆	Granite	✗
Artificial stone – hard	✗	Lime/sandstone – hard	✓
Brick – very hard, engineering brick	✓	Lime/sandstone – soft/abrasive	◆
Brick – medium	✓	Marble	✗
Brick – soft	◆	Tiles	✗
Concrete	✗		

✓ Most suitable. Recommended for these materials.
✗ Not suitable. Not recommended for these materials.

◆ Limited suitability – recommended for intermittent use.
Very good in drilling characteristics, but reduced lifetime.

Description	Diameter (mm)	Core reception	Working length (mm) B	Total length (mm) A	Pack quantity	Min. order quantity	Article Number	EAN Code
DCHXL 38*	38	1 1/4" UNC	420	490	1	1	4932399753	4002395364060
DCHXL 52	52	1 1/4" UNC	420	490	1	1	4932399163	4002395357703
DCHXL 68	68	1 1/4" UNC	420	490	1	1	4932399164	4002395357710
DCHXL 82	82	1 1/4" UNC	420	490	1	1	4932399165	4002395357727
DCHXL 102	102	1 1/4" UNC	420	490	1	1	4932399166	4002395357734
DCHXL 107	107	1 1/4" UNC	420	490	1	1	4932399754	4002395364077
① DCHXL 112	112	1 1/4" UNC	420	490	1	1	4932399167	4002395357741
DCHXL 117	117	1 1/4" UNC	420	490	1	1	4932399755	4002395364084
DCHXL 122	122	1 1/4" UNC	420	490	1	1	4932399168	4002395357758
DCHXL 127	127	1 1/4" UNC	420	490	1	1	4932399169	4002395357765
DCHXL 132	132	1 1/4" UNC	420	490	1	1	4932399170	4002395357772
DCHXL 152	152	1 1/4" UNC	420	490	1	1	4932399171	4002395357789
DCHXL 162	162	1 1/4" UNC	420	490	1	1	4932399172	4002395357796

* During pre-drilling no centering star required.

Description	Tool reception	Core reception	Pack quantity	Min. order quantity	Article Number	EAN Code
② FIXTEC™ Clean Line Rotor (CLR)	M18 x 2.5	1 1/4" UNC	1	1	4932352172	4002395368242

Description	Pack quantity	Min. order quantity	Article Number	EAN Code
③ Guide rod for DD3-152. Requires SDS-plus pilot drill (Ø 8 x 110 mm)	1	1	4932352679	4002395373376
④ Dry drilling guide rod for MXF DCD150.	1	1	4932479580	4058546373740



Dry diamond drilling without dust extraction - DCH 150

10 mm high segments.
Laser welded segments for extra durability.
Use with the machine set to rotary only, not suitable for hammer action.

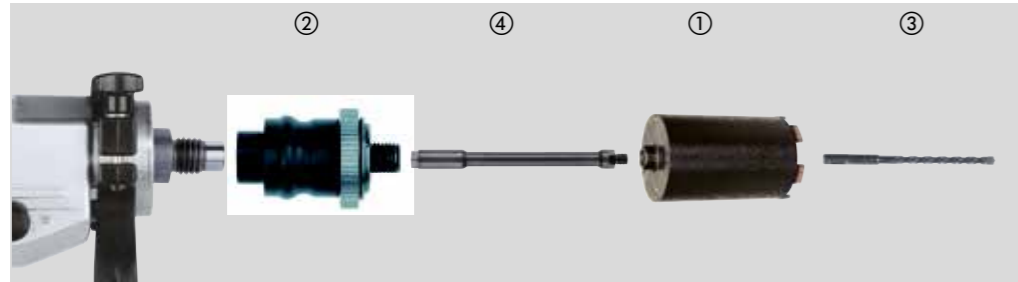

Material	DCH	Material	DCH
Aerated/breeze concrete blocks	◆	Granite	✘
Artificial stone – hard	✘	Lime/sandstone – hard	✓
Brick – very hard, engineering brick	✓	Lime/sandstone – soft/abrasive	◆
Brick – medium	✓	Marble	✘
Brick – soft	◆	Tiles	✘
Concrete	✘		

✓ Most suitable. Recommended for these materials.
 ◆ Limited suitability – recommended for intermittent use.
 Very good in drilling characteristics, but reduced lifetime.
 ✘ Not suitable. Not recommended for these materials.

Description	Diameter (mm)	Core reception	Working length (mm) B	Total length (mm) A	Pack quantity	Min. order quantity	Article Number	EAN Code
DCH 150-52	52	M16	150	180	1	1	4932352628	4002395372867
DCH 150-62	62	M16	150	180	1	1	4932352629	4002395372874
DCH 150-68	68	M16	150	180	1	1	4932352630	4002395372881
DCH 150-82	82	M16	150	180	1	1	4932352631	4002395372898
DCH 150-102	102	M16	150	180	1	1	4932352632	4002395372904
DCH 150-127	127	M16	150	180	1	1	4932352633	4002395372911

Description	Tool reception	Core reception	Pack quantity	Min. order quantity	Article Number	EAN Code
FIXTEC™ adaptor. Tool changing in seconds. No extra tool required	M18 x 2.5	M16	1	1	4932399174	4002395357819
	11 mm Hex	M16	1	1	4932399220	4002395358342
Requires SDS-plus pilot drill bit (Ø 8 x 260 mm)			1	1	4932353821	4002395320141

Description	Adaptor reception	Core reception	Total length (mm) A	Pack quantity	Min. order quantity	Article Number	EAN Code
Extension between FIXTEC adaptor and diamond core	M16	M16	300	1	1	4932369736	4002395346028

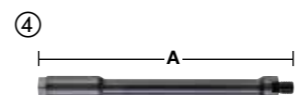

SHOCKWAVE™ IMPACT DUTY

PRECISION THAT KEEPS PACE WITH POWER

The new SHOCKWAVE™ Gen 4 Screwdriving Bits feature the strongest SHOCK ZONE™ ever - built to absorb torque and take the hit. The updated Wear Guard Tip™ grips better, strips less, and stays sharp job after job.

When the job demands more, SHOCKWAVE™ delivers.

MOST DURABLE SHOCK ZONE™

Shank absorbs peak torque, prevents breaking

LONG LASTING WEAR GUARD TIP™

Customised tip geometry, less stripping

SHOCKWAVE™ IMPACT DUTY
screwdriving bits

IMPACT

Designed for use with impact drivers the SHOCKWAVE™ IMPACT DUTY accessory line is not only ideal for heavy duty impact applications, but also delivers a full system solution for all the user's drilling and fastening needs.

Laser hardened WEAR GUARD TIP™ for improved wear resistance and protection of the fit over the life of the bit.

SHOCK ZONE™ Geometry - designed to flex:

SHOCK ZONE™ reduces stress at the tip resulting in less tip breakages. The combination of the SHOCK ZONE™ design and special heat treatment absorbs impacts and allows the bit to flex with spring like action.

Custom engineered steel - Milwaukee® custom metal formula makes the SHOCKWAVE™ bits more resistant to shock from impacting.



A) 25 mm 1/4" Hex - DIN 3126 - C 6.3
 B) 50 mm 1/4" Hex - DIN 3126 - E 6.3
 C) 90 mm 1/4" Hex - DIN 3126 - E 6.3
 D) 150 mm 1/4" Hex - DIN 3126 - E 6.3

② Storage container

Minimum order quantity = 10 pcs
 (come in counter display) orders.
 > 10 pcs must be ordered in
 multiples of 10 (i.e. 10,20,30)

Type	Total length (mm)	Supplied in	Pack quantity	Min. order quantity	Article Number	EAN Code
Philips	PH 1					
	25		3	1	4932500352	4058546616540
	50		1	1	4932471564	4058546294632
	90		1	1	4932430851	4002395385133
	PH 2					
	25		3	1	4932500353	4058546616557
	25	②	25	10	4932430853	4002395385157
	50		1	1	4932430854	4002395385164
	50	②	10	10	4932430855	4002395385171
	90		1	1	4932430856	4002395385188
	150		1	1	4932471565	4058546294649
	PH 3					
25		3	1	4932500354	4058546616564	
50		1	1	4932430858	4002395385201	
90		1	1	4932430859	4002395385218	
PZ 1						
25		3	1	4932500355	4058546616571	
25	②	25	10	4932430861	4002395385232	
50		1	1	4932471566	4058546294656	
50	②	10	10	4932500231	4058546615338	
90		1	1	4932430862	4002395385249	
150		1	1	4932500393	4058546616953	
PZ 2						
25		3	1	4932500356	4058546616588	
25	②	25	10	4932430864	4002395385263	
50		1	1	4932430865	4002395385270	
50	②	10	10	4932430866	4002395385287	
90		1	1	4932430867	4002395385294	
150		1	1	4932471928	4058546298272	
PZ 3						
25		3	1	4932500357	4058546616595	
25	②	25	1	4932430869	4002395385317	
50		1	1	4932430870	4002395385324	
150		1	1	4932471929	4058546298289	

Type	Total length (mm)	Supplied in	Pack quantity	Min. order quantity	Article Number	EAN Code
TORX®	TX 7					
	25		3	1	4932500358	4058546616601
TX 8						
	25		3	1	4932500359	4058546616618
TX 9						
	25		3	1	4932500360	4058546616625
TX 10						
	25		3	1	4932500361	4058546616632
	50		1	1	4932471570	4058546294694
	90		1	1	4932500233	4058546615352
TX 15						
	25		3	1	4932500362	4058546616649
	25	②	25	10	4932430873	4002395385355
	50		1	1	4932451286	4002395157440
	90		1	1	4932471571	4058546294700
	150		1	1	4932471572	4058546294717
TX 20						
	25		3	1	4932500363	4058546616656
	25	②	25	10	4932430875	4002395385379
	50		1	1	4932430876	4002395385386
	50	②	10	10	4932430877	4002395385393
	90		1	1	4932430878	4002395385409
	150		1	1	4932471573	4058546294724
TX 25						
	25		3	1	4932500364	4058546616663
	25	②	25	10	4932430880	4002395385423
	50		1	1	4932430881	4002395385430
	50	②	10	10	4932430882	4002395385447
	90		1	1	4932430883	4002395385454
	150		1	1	4932500392	4058546616946
TX 27						
	25		3	1	4932500365	4058546616670
TX 30						
	25		3	1	4932500366	4058546616687
	25	②	25	10	4932430886	4002395385485
	50		1	1	4932430887	4002395385492
	50	②	10	10	4932471574	4058546294731
	90		1	1	4932471575	4058546294748
TX 40						
	25		3	1	4932500367	4058546616694
	25	②	25	10	4932430889	4002395385515
	50		1	1	4932430890	4002395385522
TX 45						
	25		3	1	4932500394	4058546616960
TX 50						
	25		3	1	4932500368	4058546616700
	25	②	15	10	4932430892	4002395385546

② Storage container

Minimum order quantity = 10 pcs
 (come in counter display) orders.
 > 10 pcs must be ordered in
 multiples of 10 (i.e. 10,20,30)

SHOCKWAVE™ IMPACT DUTY

SHOCKWAVE™ IMPACT DUTY

Type	Total length (mm)	Supplied in	Pack quantity	Min. order quantity	Article Number	EAN Code	
TORX® B0	TX B07	25	①	3	1	4932500369	4058546616717
	TX B08	25	①	3	1	4932500370	4058546616724
	TX B09	25	①	3	1	4932500371	4058546616731
	TX B010	25	①	3	1	4932500372	4058546616748
	TX B015	25	①	3	1	4932500373	4058546616755
	TX B020	25	①	3	1	4932500374	4058546616762
	TX B025	25	①	3	1	4932500375	4058546616779
	TX B030	25	①	3	1	4932500376	4058546616786
	TX B040	25	①	3	1	4932500377	4058546616793
	Hex	Hex 2.5 mm	25	①	3	1	4932500378
Hex 3 mm		25	①	3	1	4932500379	4058546616816
Hex 4 mm		25	①	3	1	4932500380	4058546616823
Hex 5 mm		25	①	3	1	4932500381	4058546616830
Hex 6 mm		25	①	3	1	4932500382	4058546616847
Hex 8 mm		25	①	3	1	4932500383	4058546616854
Hex 10 mm		25	①	3	1	4932500384	4058546616861
Slotted	SL 0.6 x 4.5	25	①	3	1	4932500386	4058546616885
	SL 0.8 x 5.5	25	①	3	1	4932500387	4058546616892
	SL 1.2 x 6.5	25	①	3	1	4932500388	4058546616908
Square	SQ 1	50	①	1	1	4932500390	4058546616922
	SQ 2	50	①	1	1	4932500391	4058546616939

SHOCKWAVE™ IMPACT DUTY sets

Description	Pack quantity	Min. order quantity	Article Number	EAN Code
SHOCKWAVE™ IMPACT DUTY Carabiner Set 1 (10 pc) SHOCKWAVE™ screwdriving bits: 10 x 50mm length: 2 x PH2 / 1 x PZ2 / 1 x TX15 / 2 x TX20 / 2 x TX25 / 1 x TX30 / 1 x TX40	10	50	4932480941	4058546412265
SHOCKWAVE™ IMPACT DUTY Carabiner Set 2 (10 pc) Shockwave™ Impact Rated Screwdriving Bits: 10 x 50mm length: 4 x PH2 / 4 x PZ2 / 1 x TX20 / 1 x TX25	10	50	4932492939	4058546478100
SHOCKWAVE™ IMPACT DUTY Carabiner Set 3 (10 pc) Shockwave™ Impact Rated Screwdriving Bits: 10 x 50mm length: 1 x PZ1, 3 x PZ2, 3 x PZ3, 1 x TX20, 1 x TX25, 1 x TX30	10	50	4932500397	4058546616991
SHOCKWAVE™ IMPACT DUTY puck bit set (15 pc) SHOCKWAVE™ screwdriving bits: 14 x 25 mm length: 1 x PH1 / 2 x PH2, 1 x PZ1 / 2 x PZ2 / 1 x PZ3, 1 x TX10 / 2 x TX15 / 2 x TX20 / 1 x TX25 / 1 x TX30, 1 x SHOCKWAVE™ magnetic bit holder 60 mm length	15	10	4932430904	4002395385669
SHOCKWAVE™ IMPACT DUTY bit set (32 pc) SHOCKWAVE™ screwdriving bits: 31 x 25 mm length: 1 x PH1 / 2 x PH2 / 1 x PH3, 1 x PZ1 / 2 x PZ2 / 1 x PZ3, 2 x TX10 / 2 x TX15 / 3 x TX20 / 2 x TX25 / 2 x TX30 / 1 x TX40, 1 x TX B07 / 1 x TX B08 / 1 x TX B09 / 1 x TX B010 / 1 x TX B015 / 1 x TX B020 / 1 x TX B025, 1 x Hex 3 mm / 1 x Hex 4 mm / 1 x Hex 5 mm / 1 x Hex 6 mm, 1 x SHOCKWAVE™ locking bit holder 1/4" Hex reception 73 mm long	32	12	4932464240	4058546221850
SHOCKWAVE™ IMPACT DUTY TX bit set (32 pc) SHOCKWAVE™ TX screwdriving bits: 31 x 25 mm length: 2 x TX10 / 4 x TX15 / 5 x TX20 / 5 x TX25 / 5 x TX30 / 2 x TX40 / 1 x TX50, 1 x TX B07 / 1 x TX B08 / 1 x TX B09 / 1 x TX B010 / 1 x TX B015 / 1 x TX B020 / 1 x TX B025, 1 x SHOCKWAVE™ locking bit holder 1/4" Hex reception 73 mm long	32	12	4932471586	4058546294854
SHOCKWAVE™ IMPACT DUTY bit set (35 pc) SHOCKWAVE™ screwdriving bits: 24 x 25 mm length 1 x PH1 / 3 x PH2 / 1 x PH3, 2 x PZ1 / 3 x PZ2 / 1 x PZ3, 2 x TX10 / 2 x TX15 / 3 x TX20 / 3 x TX25 / 2 x TX30 / 1 x TX40, 7 x 50 mm length 1 x PH2 / 1 x PZ2, 1 x TX15 / 1 x TX20 / 1 x TX25 / 1 x TX30 / 1 x TX40, 3 x SHOCKWAVE™ magnetic nut drivers: 48 mm length 1 x Hex 7 mm / 1 x Hex 8 mm / 1 x Hex 10 mm, 1 x SHOCKWAVE™ magnetic bit holder 60 mm length	35	6	4932492003	4058546413705
SHOCKWAVE™ IMPACT DUTY bit set (38 pc) SHOCKWAVE™ screwdriving bits: 16 x 25 mm length 1 x PH1 / 2 x PH2, 1 x PZ1 / 2 x PZ2, 1 x TX10 / 1 x TX15 / 2 x TX20 / 3 x TX25 / 2 x TX30 / 1 x TX40, 21 x 50 mm length 1 x PH1 / 3 x PH2 / 1 x PH3, 1 x PZ1 / 3 x PZ2 / 1 x PZ3, 1 x TX10 / 1 x TX15 / 1 x TX20 / 2 x TX25 / 3 x TX30 / 3 x TX40, 1 x SHOCKWAVE™ magnetic bit holder 60 mm length	38	6	4932492009	4058546413767
SHOCKWAVE™ IMPACT DUTY bit set (40 pc) SHOCKWAVE™ screwdriving bits: 25 x 25 mm length 1 x PH1 / 2 x PH2, 1 x PZ1 / 3 x PZ2, 2 x TX10 / 2 x TX15 / 3 x TX20 / 2 x TX25 / 2 x TX30 / 1 x TX40 / 1 x TX50, 1 x Hex 4 mm / 1 x Hex 5 mm, 1 x SL 0.6 x 4.5 / 1 x SL 0.8 x 5.5 / 1 x SL 1.2 x 6.5, 8 x 50 mm length 1 x PH2, 1 x PZ1 / 1 x PZ2, 1 x TX10 / 1 x TX15 / 1 x TX20 / 1 x TX25 / 1 x TX30, SHOCKWAVE™ magnetic bit holder: 1 x 60 mm length, 1 x 152 mm length, 3 x SHOCKWAVE™ 1/4" Hex drill bits: Ø 3 / 4 / 5 mm, 2 x SHOCKWAVE™ magnetic nut drivers: 48 mm length 1 x Hex 8 mm / 1 x Hex 10 mm	40	6	4932492004	4058546413712

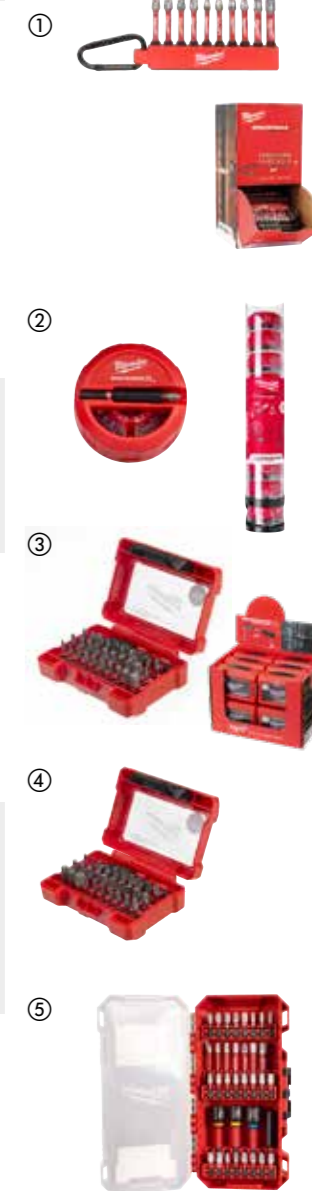

SHOCKWAVE™ IMPACT DUTY

SHOCKWAVE™ IMPACT DUTY

SHOCKWAVE™ IMPACT DUTY sets

DESIGNED FOR USE IN
PACKOUT™



Description	Pack quantity	Min. order quantity	Article Number	EAN Code
-------------	---------------	---------------------	----------------	----------

SHOCKWAVE™ IMPACT DUTY bit set (48 pc)
SHOCKWAVE™ screwdriving bits: 24 x 25 mm length 1 x PH1 / 3 x PH2 / 1 x PH3, 1 x PZ1 / 3 x PZ2 / 1 x PZ3, 2 x TX10 / 1 x TX15 / 3 x TX20 / 3 x TX25 / 2 x TX30 / 1 x TX40, 1 x Hex 4 mm / 1 x Hex 5 mm.
⑧ 16 x 50 mm length 2 x PH2 / 1 x PH3, 2 x PZ2 / 1 x PZ3, 1 x TX10 / 1 x TX15 / 2 x TX20 / 2 x TX25 / 2 x TX30 / 2 x TX40. 4 x 90 mm length 1 x PH2, 1 x PZ2, 1 x TX20 / 1 x TX25. 1 x SHOCKWAVE™ magnetic bit holder 60 mm length. 3 x SHOCKWAVE™ 1/4" Hex multi - material drill bits: Ø 5 / 6 / 8 mm

SHOCKWAVE™ IMPACT DUTY bit set (56 pc)
SHOCKWAVE™ screwdriving bits: 48 x 25 mm length 2 x PH1 / 3 x PH2 / 1 x PH3, 3 x PZ1 / 4 x PZ2 / 2 x PZ3, 3 x TX10 / 3 x TX15 / 4 x TX20 / 4 x TX25 / 4 x TX30 / 3 x TX40 / 2 x TX50, 2 x Hex 4 mm / 2 x Hex 5 mm, 2 x SL 0.6 x 4.5 / 2 x SL 0.8 x 5.5 / 2 x SL 1.2 x 6.5. 7 x 50 mm length 1 x PH2, 1 x PZ1 / 1 x PZ2, 1 x TX10 / 1 x TX15 / 1 x TX20 / 1 x TX25. 1 x SHOCKWAVE™ magnetic bit holder 60 mm length

SHOCKWAVE™ IMPACT DUTY bit set (70 pc)
SHOCKWAVE™ screwdriving bits: 48 x 25 mm length 1 x PH1 / 2 x PH2, 3 x PZ1 / 24 x PZ2 / 5 x PZ3, 1 x TX10 / 1 x TX15 / 2 x TX20 / 2 x TX25 / 2 x TX30 / 1 x TX40, 2 x Hex 4 mm / 2 x Hex 5 mm. 19 x 50 mm length 1 x PH1 / 3 x PH2, 1 x PZ1 / 5 x PZ2 / 3 x PZ3, 1 x TX20 / 1 x TX25 / 2 x TX30 / 2 x TX40. 2 x SHOCKWAVE™ nut drivers 48 mm length: Hex 8 mm / Hex 10 mm. 1 x SHOCKWAVE™ magnetic bit holder 60 mm length

SHOCKWAVE™ IMPACT DUTY XL TX bit set (75 pc)
SHOCKWAVE™ screwdriving bits: 60 x 25 mm length 1 x PH1 / 2 x PH2, 1 x PZ1 / 3 x PZ2 / 1 x PZ3, 2 x TX10 / 4 x TX15 / 12 x TX20 / 12 x TX25 / 12 x TX30 / 2 x TX40 / 1 x TX50, 1 x TX B07 / 1 x TX B08 / 1 x TX B09 / 1 x TX B010 / 1 x TX B015, 1 x Hex 4 mm / 1 x Hex 5 mm. 12 x 50 mm length 1 x PH2, 1 x PZ1 / 1 x PZ2, 1 x TX10 / 2 x TX15 / 2 x TX20 / 2 x TX25 / 2 x TX30. 2 x SHOCKWAVE™ nut drivers 48 mm length: Hex 8 mm / Hex 10 mm. 1 x SHOCKWAVE™ magnetic bit holder 60 mm length

SHOCKWAVE™ IMPACT DUTY locking bit holder

Dual internal magnets ensure magnetism to fasteners.
Auto-Locking - One handed bit release.
1/4" Hex reception (DIN 3126 - E 6.3). Very suitable for high torque and impact applications.

Description	Total length (mm) A	Pack quantity	Min. order quantity	Article Number	EAN Code
① Locking bit holder 73 mm	73	1	1	4932459398	4058546010591
② Locking bit holder 152 mm - long series	152	1	1	4932471824	4058546297237
③ Locking bit holder 305 mm - long series	305	1	1	4932471825	4058546297244

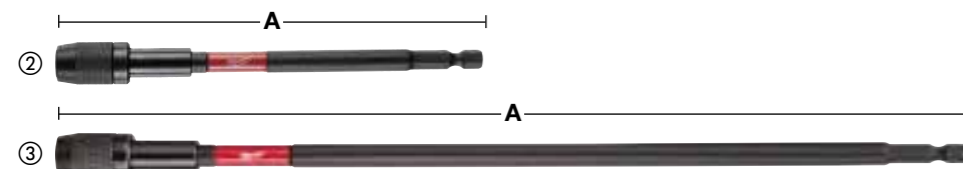

SHOCKWAVE™ IMPACT DUTY magnetic bit holder

Custom engineered steel and heat treatment for maximum strength and flexibility.
Optimised SHOCK ZONE™ absorbs up to 3X more torque for more resistance to shock from impacting.
Strong magnetic tip for secure grip.
1/4" Hex reception (DIN 3126 - E 6.3). Very suitable for high torque and impact applications.

Description	Total length (mm) A	Pack quantity	Min. order quantity	Article Number	EAN Code
① Magnetic bit holder 60 mm	60	1	1	4932352406	4002395370658
② Magnetic bit holder 60 mm - jam jar (100pc)	60	1	100	4932430478	4002395381395
③ Magnetic bit holder 152 mm - long series	152	1	1	4932471822	4058546297213
④ Magnetic bit holder 305 mm - long series	305	1	1	4932471823	4058546297220
Magnetic Bit Holder Drive Guide 75 mm	75	1	1	4932500395	4058546616977
Magnetic Bit Holder Screw Engaging 75 mm	75	1	1	4932500396	4058546616984

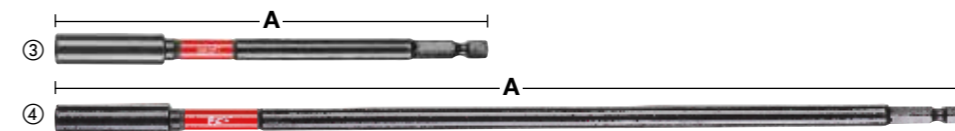

SHOCKWAVE™ IMPACT DUTY magnetic nut drivers

Custom engineered steel and heat treatment for maximum strength and extreme durability.
Strong magnetic tip for secure grip.
1/4" Hex reception (DIN 3126 - E 6.3). Very suitable for high torque and impact applications.

Size AF (across flats) (mm)	For anchor thread size	Total length (mm)	Pack quantity	Min. order quantity	Article Number	EAN Code
5.5	M3	65	1	1	4932492434	4058546418014
6	M3.5	65	1	1	4932492435	4058546418021
1/4"	-	65	1	1	4932492436	4058546418038
7	M4	65	1	1	4932492437	4058546418045
5/16"	-	65	1	1	4932492438	4058546418052
8	M5	65	1	1	4932492439	4058546418069
8	M5	150	1	1	4932492446	4058546418137
3/8"	-	65	1	1	4932492440	4058546418076
10	M6	65	1	1	4932492441	4058546418083
10	M6	150	1	1	4932492447	4058546418144
12	M7	65	1	1	4932492442	4058546418090
13	M8	65	1	1	4932492443	4058546418106
13	M8	150	1	1	4932492448	4058546418151
17	M10	65	1	1	4932492444	4058546418113
SHOCKWAVE™ IMPACT DUTY magnetic nut driver set (4pc)						
①	Ø 7 / 8 / 10 / 13 mm		4	1	4932492445	4058546418120
Nut Driver long Set (3)						
②	150 mm size 8,10,13		3	1	4932499426	4058546565909

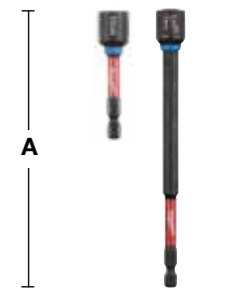

DESIGNED FOR USE IN
PACKOUT™

SHOCKWAVE™ IMPACT DUTY

SHOCKWAVE™ IMPACT DUTY

SHOCKWAVE™ Dual Nut Drivers

The Dual SHOCKWAVE™ IMPACT DUTY Nut Drivers features the most durable magnet and 2-in-1 size versatility.

The cleaning mechanism allows fast and easy removal of metal shavings from the magnet to prevent fastener from head stripping.

The Dual Nut Drivers features a powerful magnet that allows a strong fastener engagement.

The optimized SHOCK ZONE™ absorbs peak torque and prevents bit breakage.

Made from heat treated steel to control hardness and extend bit life.

The nut drivers feature two color-coded rings for quick and easy size identification.

Designed for use with impact drivers and drill drivers.



Size AF (across flats) (mm)	For anchor thread size	Total length (mm)	Pack quantity	Min. order quantity	Article Number	EAN Code
7 - 8	M4 - M5	65	1	1	4932493343	4058546482145
8 - 10	M5 - M6	65	1	1	4932493344	4058546482152
10 - 13	M6 - M8	65	1	1	4932493345	4058546482169
Dual Nut Driver Set (3)			3	1	4932493559	4058546484309
1 x 7-8mm, 1 x 8-10mm, 1 x 10-13mm						

SHOCKWAVE™ IMPACT DUTY socket adaptors - Hex reception

Description	Total length (mm) A	Pack quantity	Min. order quantity	Article Number	EAN Code
① Socket adaptor: 1/4" Hex - 1/4" square. DIN 3126 - E 6.3	50	1	1	4932471826	4058546297251
② Socket adaptor: 1/4" Hex - 3/8" square. DIN 3126 - E 6.3	50	1	1	4932478054	4058546339876
③ Socket adaptor: 1/4" Hex - 1/2" square. DIN 3126 - E 6.3	50	1	1	4932478803	4058546360856
④ Socket adaptor: 7/16" Hex - 1/2" square	70	1	1	4932480586	4058546408718
SHOCKWAVE™ IMPACT DUTY socket adaptor set (3pc)		3	1	4932479228	4058546370220
⑤ 1 x 1/4" Hex - 1/4" square, 1 x 1/4" Hex - 3/8" square, 1 x 1/4" Hex - 1/2" square					



SHOCKWAVE™ right angle attachment

The right angle attachment is a useful device for screwdriving or drilling applications in restricted, difficult to reach areas.

Impact rated: suitable to use with latest 18V impact drivers as well as cordless drill drivers.

Internal SHOCK ZONE™ and advanced gear design for excellent power transmission and impact durability. For all 1/4" Hex driving and drilling accessories.

Very compact design: only 36 mm in height and a true 90° angle to allow access into confined spaces.

Ergonomic rubber overmold for secure and comfortable handling.

Pack contains 1 x right angle attachment and 10 x 25 mm screwdriving bits.

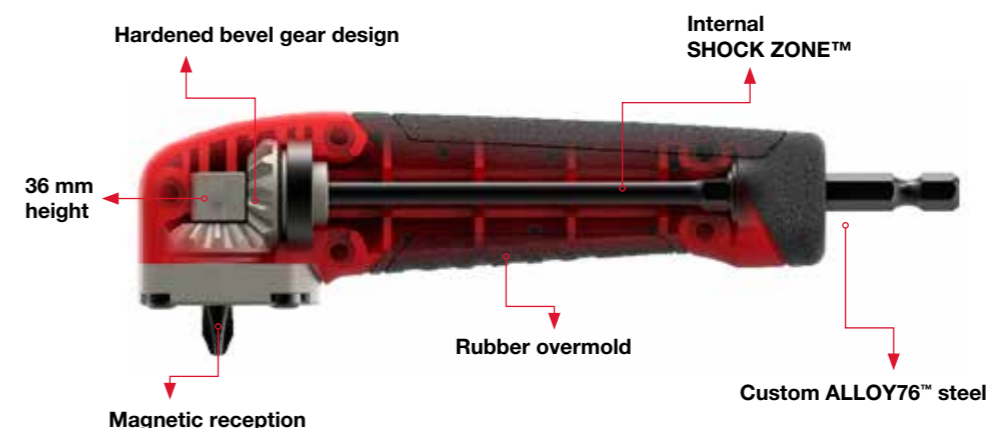

Description	Pack quantity	Min. order quantity	Article Number	EAN Code
Counter display SHOCKWAVE™ Right Angle Attachment set (11pc)	11	12	4932471274	4058546289027
1 x Right Angle Attachment, 1 x PH2, 1 x PZ1 / 2 x PZ2 / 1 x PZ3, 1 x TX10 / 1 x TX15 / 1 x TX20 / 1 x TX25 / 1 x TX30				

SHOCKWAVE™ KNUCKLE™ offset attachment

Impact rated: suitable to use with latest 18V impact drivers as well as cordless drill drivers.

Very compact offset attachment.

Ideally suited to working in confined and limited spaces.

Solid metal construction to absorb impact action.

0° and 30° positions.

1/4" Hex shank fits directly into the chuck preventing slippage.



* Height when 30° tilted 40 mm

Description	Pack quantity	Min. order quantity	Article Number	EAN Code
Counter display KNUCKLE™ set (11pc)	11	10	4932459781	4058546029531
1 x KNUCKLE™, 1 x PH1 / 2 x PH2, 1 x PZ1 / 2 x PZ2 / 1 x PZ3, 1 x TX15 / 1 x TX20 / 1 x TX25				

OSD2 - Offset screwdriver/ drill angle attachment

The OSD 2 screwdriver / drill angle attachment is the ideal solution for all screwdriving and drilling applications in restricted areas. 1/4" magnetic Hex bit reception accepts both standard 25 mm (C 6.3) and ball end reception (E 6.3), with bit locking mechanism. Metal gears and housing for smooth and precise running and excellent power transmission. 360° rotatable softgrip side handel for left and right hand use with 4 lock positions. Two step Hex shaft to fit either 1/4" (6 mm) Hex shaft or 10 mm Hex shaft. Industrial quality designed for use with all cordless tools in applications up to 40 Nm torque and a maximum of 1750 rpm. The OSD2 is capable of both drilling and screwdriving applications, offering maximum versatility. Only 51 mm in height for use in confined spaces.



Description	Pack quantity	Min. order quantity	Article Number	EAN Code
① OSD 2	1	1	4932352320	4002395369799
② Counter display 6 x OSD 2 (4932352320)	6	1	4932352321	4002395369805

Screwdriving Bits



The ribs are cold formed to exact specification ensuring reduced wear from slippage. The tip is subjected to a special hardening process with temperatures up to 870°C.

The outcome is a bit with a hardness of 60 HRC. This extra hard tip ensures extra long life under constant use.

The body is manufactured from the highest quality S2 european steel.

The sign of quality: All bits are laser marked with the MILWAUKEE® logo and tip reception for easy identification.

Type	Total length (mm)	Pack quantity	Min. order quantity	Article Number	EAN Code	
Phillips	PH 1	25	25	1	4932399586	4002395362363
	PH 2	25	25	1	4932399587	4002395362370
	PH 3	25	25	1	4932399588	4002395362387
PoziDrive	PZ 1	25	25	1	4932399589	4002395362394
	PZ 2	25	25	1	4932399590	4002395362400
	PZ 3	25	25	1	4932399591	4002395362417
Torx	TX 10	25	25	1	4932399594	4002395362448
	TX 10	25	25	10	4932500398	4058546617004
	TX 15	25	25	1	4932399595	4002395362455
	TX 20	25	25	1	4932399596	4002395362462
	TX 25	25	25	1	4932399597	4002395362479
	TX 30	25	25	1	4932399599	4002395362493
	TX 40	25	25	1	4932399600	4002395362509

Screwdriving bit cassettes

This high quality cassette aimed at the professional user is available in 3 different assortments.

Slimline pocket design: 110 mm x 65 mm x 15 mm.

Secure latch system - easy opening and safe closing.

Extra side compartment accepts either 50 mm screwdriving bits or drill bits.

Front window to protect bits from dust.

High quality screwdriving bits with hardness of 60 HRC and 1/4" Hex reception. 25 mm bits manufactured according to DIN 3126 - C 6.3. 50 mm bits are manufactured according to DIN 3126 - E 6.3.

Magnetic bit holder with quick release clutch.

Description	Pack quantity	Min. order quantity	Article Number	EAN Code
Compact screwdriving bit set (12pc) 25 mm: SL 0.8 x 5.5 mm x 1.25 mm: PH 1 x 1 / PH 2 x 2 / PH 3 x 1. 25 mm: PZ 1 x 1 / PZ 2 x 2 / PZ 3 x 1. 50 mm: PH 2 x 1. 50 mm: PZ 2 x 1. Magnetic bit holder with quick release clutch	12	1	4932399513	4002395361601



Screwdriving bits sets

Description	Pack quantity	Min. order quantity	Article Number	EAN Code
Screwdriving bit set (27pc) Screwdriving bits 25 mm length: PH 1 x 2 / PH 2 x 2 / PH 3 x 1. PZ 1 x 2 / PZ 2 x 4 / PZ 3 x 2. TX 10 x 2 / TX 15 x 3 / TX 20 x 3. TX 25 x 3 / TX 30 x 1 / TX 40 x 1. Magnetic bit holder with quick release clutch.	27	1	4932352747	4002395374052



Magnetic bit holders

Description	Pack quantity	Min. order quantity	Article Number	EAN Code
① Magnetic bit holder with quick release clutch, total length 58 mm	1	1	4932373483	4002395351060
② Magnetic bit holder for drywall	1	1	4932430179	4002395378401



NEXT GENERATION SHOCKWAVE IMPACT SOCKETS

SHOCKWAVE
IMPACT DUTY

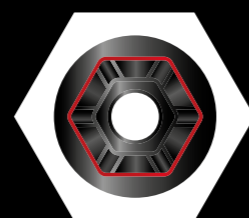

**6 POINT
HEX GEOMETRY**



**DUAL HOLE
DESIGN FOR EASIER
ATTACHMENT**



**LASER-ETCHED
LOGO & PART NUMBER**



**STAMPED
AND INK
FILLED SIZES**

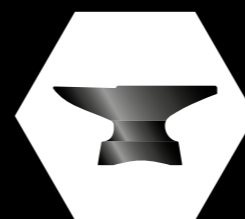

**FORGED
HIGH TORQUE
IMPACT STEEL**

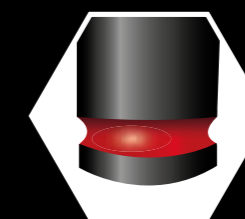

**COLOUR
BAND
INK FILLED**

1/4" SHOCKWAVE™ IMPACT DUTY impact sockets - deep

A (mm)	B (mm)	C (mm)	D (mm)	E (mm)	For anchor thread size	Pack quantity	Min. order quantity	Article Number	EAN Code
1/4" square	4	50	1.9	7.60	M2	1	1	4932480251	4058546405366
1/4" square	4.5	50	2.2	8	-	1	1	4932480252	4058546405373
1/4" square	5	50	2.8	8	M2.5	1	1	4932480253	4058546405380
1/4" square	5.5	50	2.8	8.5	M3	1	1	4932480254	4058546405397
1/4" square	6	50	3.1	9.6	M3.5	1	1	4932480255	4058546405403
1/4" square	7	50	3.6	10.8	M4	1	1	4932480256	4058546405410
1/4" square	8	50	3.6	12	M5	1	1	4932480257	4058546405427
1/4" square	9	50	4.1	13	-	1	1	4932480258	4058546405434
1/4" square	10	50	4.6	13.8	M6	1	1	4932480259	4058546405441
1/4" square	11	50	5.5	13.8	-	1	1	4932480260	4058546405458
1/4" square	12	50	6.1	14.7	M7	1	1	4932480261	4058546405465
1/4" square	13	50	6.8	15.7	M8	1	1	4932480262	4058546405472

1/4" SHOCKWAVE™ IMPACT DUTY socket rail set (12pc)

12 x 1/4" sockets: 4 / 4.5 / 5 / 5.5 / 6 / 7 / 8 / 9 / 10 / 11 / 12 / 13 and socket rail



1/4" SHOCKWAVE™ IMPACT DUTY Foam Inserts

Description	Pack quantity	Min. order quantity	Article Number	EAN Code
1/4" SHOCKWAVE™ IMPACT DUTY Sockets deep foam set (17pc)	17	1		
SHOCKWAVE™ IMPACT DUTY 1/4" deep sockets: 4/4.5/5/5.5/6/7/8/9/10/11/12/13mm, magnetic bit holder 152 mm, magnetic bit holder 305mm, screwdriving bit set 32 pcs, adaptor 1/4" Hex --> 1/4" square, adaptor 1/4" square --> 1/4" Hex, Foam 417x177mm			4932493386	4058546482572
Replacement foam for 1/4" deep sockets. Size 417x177mm	1	1	4932493385	4058546482565



Adaptor ShW 1/4" SQ - 1/4" Hex-1pc

Socket adapter 1/4" square to 1/4" Hex
Only suitable for screwdriving bits >50mm

Description	Total length (mm)	Pack quantity	Min. order quantity	Article Number	EAN Code
Socket adaptor, 1/4" square - 1/4" hex	45	1	1	4932493425	4058546482961



3/8" SHOCKWAVE™ IMPACT DUTY impact sockets - standard

A (mm)	B (mm)	C (mm)	D (mm)	E (mm)	For anchor thread size	Pack quantity	Min. order quantity	Article Number	EAN Code
3/8" square	6	32	3.1	10.5	M3.5	1	1	4932480263	4058546405489
3/8" square	7	32	3.1	12.6	M4	1	1	4932480264	4058546405496
3/8" square	8	32	3.6	13.9	M5	1	1	4932480265	4058546405502
3/8" square	9	32	4.1	14.5	-	1	1	4932480266	4058546405519
3/8" square	10	32	4.6	15.8	M6	1	1	4932480267	4058546405526
3/8" square	11	32	5.5	16.9	-	1	1	4932480268	4058546405533
3/8" square	12	32	6.1	18.2	M7	1	1	4932480269	4058546405540
3/8" square	13	32	6.8	19.5	M8	1	1	4932480270	4058546405557
3/8" square	14	32	8.4	20.5	-	1	1	4932480271	4058546405564
3/8" square	15	32	8.4	21.8	-	1	1	4932480272	4058546405571
3/8" square	16	32	9.6	23.8	M10 (ISO)	1	1	4932480273	4058546405588
3/8" square	17	34	9.6	24.8	M10 (DIN)	1	1	4932480274	4058546405595
3/8" square	18	34	10.2	25.8	M12	1	1	4932480275	4058546405601
3/8" square	19	34	11	27.6	-	1	1	4932480276	4058546405618
3/8" square	20	34	11	27.8	-	1	1	4932480277	4058546405625
3/8" square	21	34	11.7	29.8	M14	1	1	4932480278	4058546405632
3/8" square	22	34	12.5	31.6	-	1	1	4932480279	4058546405649

3/8" SHOCKWAVE™ IMPACT DUTY socket standard rail set (9pc)

8 x impact standard sockets: 8 / 10 / 12 / 13 / 14 / 15 / 17 / 19 mm and socket rail

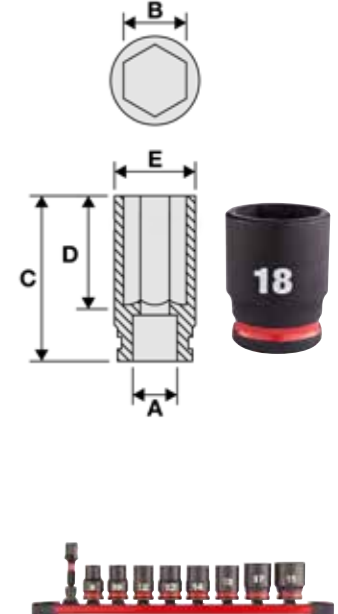

3/8" SHOCKWAVE™ IMPACT DUTY impact sockets - deep

A (mm)	B (mm)	C (mm)	D (mm)	E (mm)	For anchor thread size	Pack quantity	Min. order quantity	Article Number	EAN Code
3/8" square	6	65	3.1	10.5	M3.5	1	1	4932480280	4058546405656
3/8" square	7	65	3.6	12.6	M4	1	1	4932480281	4058546405663
3/8" square	8	65	3.6	13.9	M5	1	1	4932480282	4058546405670
3/8" square	9	65	4.1	14.5	-	1	1	4932480283	4058546405687
3/8" square	10	65	4.6	15.8	M6	1	1	4932480284	4058546405694
3/8" square	11	65	5.5	16.9	-	1	1	4932480285	4058546405700
3/8" square	12	65	6.1	18.8	M7	1	1	4932480286	4058546405717
3/8" square	13	65	6.8	19.5	M8	1	1	4932480287	4058546405724
3/8" square	14	65	8.4	20.5	-	1	1	4932480288	4058546405731
3/8" square	15	65	8.4	21.8	-	1	1	4932480289	4058546405748
3/8" square	16	65	9.6	23.8	M10 (ISO)	1	1	4932480290	4058546405755
3/8" square	17	65	9.6	24.8	M10 (DIN)	1	1	4932480291	4058546405762
3/8" square	18	65	10.2	25.8	M12	1	1	4932480292	4058546405779
3/8" square	19	65	11	27.6	-	1	1	4932480293	4058546405786
3/8" square	20	65	11	27.8	-	1	1	4932480294	4058546405793
3/8" square	21	65	11.7	29.8	M14	1	1	4932480295	4058546405809
3/8" square	22	65	12.5	31.6	-	1	1	4932480296	4058546405816

3/8" SHOCKWAVE™ IMPACT DUTY socket deep rail set (9pc)

8 x impact deep sockets: 8 / 10 / 12 / 13 / 14 / 15 / 17 / 19 mm and socket rail

3/8" PACKOUT™ SHOCKWAVE™ IMPACT DUTY socket set (19pc)

19 x 3/8" Impact sockets deep: 6 / 7 / 8 / 9 / 10 / 11 / 12 / 13 / 14 / 15 / 16 / 17 / 18 / 19 / 20 / 21 / 22 / 23 / 24 mm, 1 x 4932471065 PACKOUT™ slim organizer

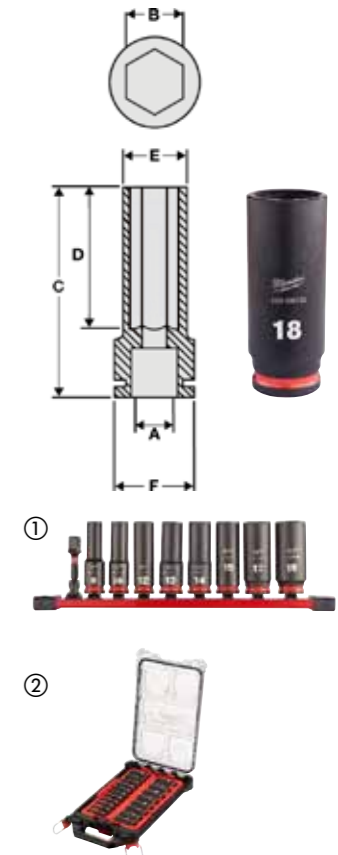

SHOCKWAVE™ IMPACT DUTY

SHOCKWAVE™ IMPACT DUTY

3/8" SHOCKWAVE™ IMPACT DUTY Foam Inserts

Description	Pack quantity	Min. order quantity	Article Number	EAN Code
3/8" sockets STD foam set (23pc)	23	1		
① SHOCKWAVE™ IMPACT DUTY 3/8" STD sockets: 6/7/8/9/10/11/12/13/14/15/16/17/18/19/20/21/22mm, extension - 150mm, extension - 250mm, adaptor 3/8" square --> 1/4" square, adaptor 3/8" square --> 1/2" square, 3/8" swivel, adaptor 3/8" square --> 1/4" Hex, Foam 417x177mm			4932493388	4058546482596
3/8" Sockets deep foam set (23pc)	23	1		
② SHOCKWAVE™ IMPACT DUTY 3/8" deep sockets: 6/7/8/9/10/11/12/13/14/15/16/17/18/19/20/21/22mm, extension - 150mm, extension - 250mm, adaptor 3/8" square --> 1/4" square, adaptor 3/8" square --> 1/2" square, swivel 3/8", adaptor 3/8" square --> 1/4" Hex, Foam 417x177mm			4932493390	4058546482619
Replacement foam for 3/8" STD sockets. Size 417x177mm	1	1	4932493387	4058546482589
Replacement foam for 3/8" deep sockets. Size 417x177mm	1	1	4932493389	4058546482602



3/8" impact sockets - extensions

Description	Total length (mm)	Pack quantity	Min. order quantity	Article Number	EAN Code
① 3/8" extension - 150 mm	150	1	1	4932480297	4058546405823
② 3/8" extension - 250 mm	250	1	1	4932480298	4058546405830

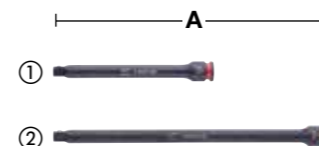

3/8" impact sockets - adaptors

Description	Total length (mm)	Pack quantity	Min. order quantity	Article Number	EAN Code
① Socket adaptor. 3/8" square - 1/4" square	28	1	1	4932480299	4058546405847
② Socket adaptor. 3/8" square - 1/2" square	37	1	1	4932480300	4058546405854
③ Socket adaptor. 3/8" square - 1/4" hex	50	1	1	4932493426	4058546482978



3/8" impact sockets - swivel joint

Description	Angle capacity	Pack quantity	Min. order quantity	Article Number	EAN Code
3/8" universal swivel joint	15°	1	1	4932480301	4058546405861



1/2" SHOCKWAVE™ IMPACT DUTY impact sockets - standard

A	B (mm)	C (mm)	D (mm)	E (mm)	For anchor thread size	Pack quantity	Min. order quantity	Article Number	EAN Code
1/2" square	8	38	4.2	15.0	M5	1	1	4932480302	4058546405878
1/2" square	9	38	4.5	16.3	-	1	1	4932480303	4058546405885
1/2" square	10	38	4.6	17.5	M6	1	1	4932480304	4058546405892
1/2" square	11	38	5.5	18.0	-	1	1	4932480305	4058546405908
1/2" square	12	38	6.1	19.0	M7	1	1	4932480306	4058546405915
1/2" square	13	38	6.8	20.0	M8	1	1	4932480307	4058546405922
1/2" square	14	38	8.4	22.0	-	1	1	4932480308	4058546405939
1/2" square	15	38	8.4	23.0	-	1	1	4932480309	4058546405946
1/2" square	16	38	9.6	24.0	M10 (ISO)	1	1	4932480310	4058546405953
1/2" square	17	38	9.6	26.2	M10 (DIN)	1	1	4932480311	4058546405960
1/2" square	18	38	10.2	27.5	M12	1	1	4932480312	4058546405977
1/2" square	19	38	11.1	28.5	-	1	1	4932480313	4058546405984
1/2" square	20	38	11.5	29.2	-	1	1	4932480314	4058546405991
1/2" square	21	38	11.7	30.0	M14	1	1	4932480315	4058546406004
1/2" square	22	38	12.5	31.8	-	1	1	4932480316	4058546406011
1/2" square	23	40	12.7	33.8	-	1	1	4932480317	4058546406028
1/2" square	24	40	13.9	34.2	M16	1	1	4932480318	4058546406035
1/2" square	25	42	14.0	35.8	-	1	1	4932480319	4058546406042
1/2" square	26	42	14.6	37.0	-	1	1	4932480320	4058546406059
1/2" square	27	42	15.0	38.2	M18	1	1	4932480321	4058546406066
1/2" square	28	42	15.4	38.8	-	1	1	4932480322	4058546406073
1/2" square	29	42	16.7	42.0	-	1	1	4932480323	4058546406080
1/2" square	30	44	16.7	42.8	M20	1	1	4932480324	4058546406097
1/2" square	31	43	25	43.8	-	1	1	4932500298	4058546616007
1/2" square	32	44	18.3	43.8	M22	1	1	4932480325	4058546406103
1/2" square	33	43	25	46.8	-	1	1	4932500299	4058546616014
1/2" square	34	47	29	46.8	-	1	1	4932500300	4058546616021
1/2" square	35	47	29	49.8	-	1	1	4932500301	4058546616038
1/2" square	36	47	29	50	-	1	1	4932500302	4058546616045

1/2" SHOCKWAVE™ IMPACT DUTY socket set STD (13pc)	Pack quantity	Min. order quantity	Article Number	EAN Code
10 x STD sockets: 10,12,13,14,15,17,19,21,22,24, 1 x universal joint 15°, 1 x adaptor 1/4" Hex - 1/2" square, 1 x extension 150 mm	13	1	4932480456	4058546407414

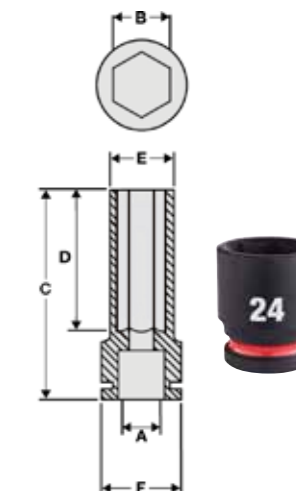

1/2" SHOCKWAVE™ IMPACT DUTY automotive impact sockets

Colour coded for easy identification.
Made from high quality alloy steel for strength and durability.
The lug nut sockets are thin-walled for easy access in tight wheel assemblies.
Supplied on a magnetic rail.

A (mm)	B (mm)	C (mm)	D (mm)	E (mm)	Pack quantity	Min. order quantity	Article Number	EAN Code
1/2" square	17	80	12	27	1	1	4932493371	4058546482428
1/2" square	19	80	12	29	1	1	4932493372	4058546482435
1/2" square	21	80	12	31	1	1	4932493373	4058546482442
1/2" square	22	80	12	33	1	1	4932493374	4058546482459

Hex Socket ShW 1/2" Auto Set-3pc	Pack quantity	Min. order quantity	Article Number	EAN Code
1/2" Automotive Hex Sockets 17/19/21 supplied on a magnetic rail	3	1	4932493370	4058546482411





1/2" SHOCKWAVE™ IMPACT DUTY impact sockets - deep

A (mm)	B (mm)	C (mm)	D (mm)	E (mm)	For anchor thread size	Pack quantity	Min. order quantity	Article Number	EAN Code	
1/2" square	8	78	4.2	15.0	M5	1	1	4932480326	4058546406110	
1/2" square	9	78	4.2	16.3	-	1	1	4932480327	4058546406127	
1/2" square	10	78	4.8	17.5	M6	1	1	4932480328	4058546406134	
1/2" square	11	78	5.5	18.0	-	1	1	4932480329	4058546406141	
1/2" square	12	78	6.1	19.0	M7	1	1	4932480330	4058546406158	
1/2" square	13	78	6.8	20.0	M8	1	1	4932480331	4058546406165	
1/2" square	14	78	8.4	22.0	-	1	1	4932480332	4058546406172	
1/2" square	15	78	8.4	23.0	-	1	1	4932480333	4058546406189	
1/2" square	16	78	9.8	24.0	M10 (ISO)	1	1	4932480334	4058546406196	
1/2" square	17	78	9.8	26.2	M10 (DIN)	1	1	4932480335	4058546406202	
1/2" square	18	78	10.2	27.0	M12	1	1	4932480336	4058546406219	
1/2" square	19	78	11.1	28.0	-	1	1	4932480337	4058546406226	
1/2" square	20	78	11.5	29.3	-	1	1	4932480338	4058546406233	
1/2" square	21	78	11.7	30.0	M14	1	1	4932480339	4058546406240	
1/2" square	22	78	12.5	31.3	-	1	1	4932480340	4058546406257	
1/2" square	23	78	12.7	33.8	-	1	1	4932480341	4058546406264	
1/2" square	24	78	13.9	34.2	M16	1	1	4932480342	4058546406271	
1/2" square	25	78	14.0	35.8	-	1	1	4932480343	4058546406288	
1/2" square	26	78	14.8	37.0	-	1	1	4932480344	4058546406295	
1/2" square	27	78	15.8	38.2	M18	1	1	4932480345	4058546406301	
1/2" square	28	78	15.8	39.2	-	1	1	4932480346	4058546406318	
1/2" square	29	78	15.8	42.0	-	1	1	4932480347	4058546406325	
1/2" square	30	78	15.8	42.9	M20	1	1	4932480348	4058546406332	
1/2" square	32	78	18.1	43.5	M22	1	1	4932480349	4058546406349	
1/2" square	33	78	47	45.3	-	1	1	4932480350	4058546406356	
1/2" square	36	78	20.0	50.0	M24	1	1	4932480351	4058546406363	
1/2" SHOCKWAVE™ IMPACT DUTY deep socket set (10pc)										
①	10 x deep sockets: 10, 11, 12, 13, 14, 17, 19, 21, 22, 24 mm						10	1	4932480457	4058546407421
1/2" PACKOUT™ SHOCKWAVE™ IMPACT DUTY socket set (16pc)										
②	16 x 1/2" Impact sockets deep: 10 / 11 / 12 / 13 / 14 / 15 / 16 / 17 / 18 / 19 / 20 / 21 / 22 / 23 / 24 / 75 mm extension, 1 x 4932464083 PACKOUT™ compact organizer						16	1	4932480943	4058546412289



1/2" SHOCKWAVE™ IMPACT DUTY Foam Inserts

Description	Pack quantity	Min. order quantity	Article Number	EAN Code
1/2" Sockets STD foam set (32pc)	32	1		
① SHOCKWAVE™ IMPACT DUTY 1/2" STD socket: 8/9/10/11/12/13/14/15/16/17/18/19/20/21/22/23/24/25/26/27/28/29/30/32mm, Automotive Set 1/2": 17/19/21mm, extension - 150mm, extension - 250mm, adaptor 1/2" square --> 3/8" square, adaptor 1/2" square --> 3/4" square, 1/2" swivel, Foam with plastic base 417x536mm			4932493392	4058546482633
1/2" Sockets deep foam set (34pc)	34	1		
② SHOCKWAVE™ IMPACT DUTY 1/2" deep Sockets: 8/9/10/11/12/13/14/15/16/17/18/19/20/21/22/23/24/25/26/27/28/29/30/32/33/36mm, Automotive Set 1/2": 17/19/21mm, extension - 150mm, extension - 250mm, adaptor 1/2" square --> 3/8" square, adaptor 1/2" square --> 3/4" square, 1/2" Swivel, Foam with plastic base 417x536mm			4932493394	4058546482657
Replacement foam with plastic base for 1/2" STD sockets. Size 417x536mm	1	1	4932493391	4058546482626
Replacement foam with plastic base for 1/2" deep sockets. Size 417x536mm	1	1	4932493393	4058546482640



1/2" impact sockets - extensions

Description	Total length (mm)	Pack quantity	Min. order quantity	Article Number	EAN Code
① 1/2" extension - 150 mm	150	1	1	4932480352	4058546406370
② 1/2" extension - 250 mm	250	1	1	4932480353	4058546406387

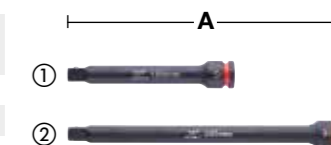

1/2" impact sockets - reducers

Description	Total length (mm)	Pack quantity	Min. order quantity	Article Number	EAN Code
① Socket adaptor. 1/2" square - 3/8" square	38	1	1	4932480354	4058546406394
② Socket adaptor. 1/2" square - 3/4" square	48	1	1	4932480355	4058546406400
③ Socket adaptor: 1/2" square - 1/4" Hex. To accept screwdriving bits	50	1	1	4932471828	4058546297275
④ 1/2" SHOCKWAVE™ IMPACT DUTY adaptor set (4pc)		4	1	4932480356	4058546406417
4 adaptors: 3/8"SQ-1/4"SQ, 3/8"SQ-1/2"SQ, 1/2"SQ-3/8"SQ, 1/2"SQ-3/4"SQ					



1/2" SHOCKWAVE™ IMPACT DUTY universal joint

Description	Angle capacity	Pack quantity	Min. order quantity	Article Number	EAN Code
1/2" SHOCKWAVE™ IMPACT DUTY universal joint	15°	1	1	4932480357	4058546406424



1/2" impact TX bit sockets

One-piece design TX bit and socket with 1/2" internal square drive reception according to DIN 3121 / ISO 1174-2. Suitable for higher torque fastening applications, fits directly onto 1/2" impact tools.

Description	Tool reception	Pack quantity	Min. order quantity	Article Number	EAN Code
TX30 1/2" impact bit socket	1/2" square	1	1	4932478059	4058546339920
TX40 1/2" impact bit socket	1/2" square	1	1	4932478060	4058546339937
TX45 1/2" impact bit socket	1/2" square	1	1	4932478061	4058546339944
TX50 1/2" impact bit socket	1/2" square	1	1	4932478062	4058546339951



1/2" impact HEX bit sockets

One-piece design HEX bit and socket with 1/2" internal square drive reception according to DIN 3121 / ISO 1174-2. Suitable for higher torque fastening applications, fits directly onto 1/2" impact tools.

Description	Tool reception	Pack quantity	Min. order quantity	Article Number	EAN Code
HEX5 1/2" impact bit socket	1/2" square	1	1	4932478063	4058546339968
HEX6 1/2" impact bit socket	1/2" square	1	1	4932478064	4058546339975
HEX8 1/2" impact bit socket	1/2" square	1	1	4932478065	4058546339982
HEX10 1/2" impact bit socket	1/2" square	1	1	4932478066	4058546339999
HEX12 1/2" impact bit socket	1/2" square	1	1	4932478067	4058546340001



SHOCKWAVE™ IMPACT DUTY

SHOCKWAVE™ IMPACT DUTY

3/4" SHOCKWAVE™ IMPACT DUTY impact sockets - standard

A (mm)	B (mm)	C (mm)	D (mm)	E (mm)	For anchor thread size	Pack quantity	Min. order quantity	Article Number	EAN Code
3/4" square	17	53	9.6	30	M10 (DIN)	1	1	4932480361	4058546406462
3/4" square	19	53	11.1	33	-	1	1	4932480362	4058546406479
3/4" square	21	53	11.7	35	M14	1	1	4932480363	4058546406486
3/4" square	22	53	12.5	36	-	1	1	4932480364	4058546406493
3/4" square	23	53	12.7	37.6	-	1	1	4932480365	4058546406509
3/4" square	24	53	13.9	38	M16	1	1	4932480366	4058546406516
3/4" square	27	53	15.8	41	M18	1	1	4932480367	4058546406523
3/4" square	30	53	16.7	46	M20	1	1	4932480368	4058546406530
3/4" square	32	57	18.3	48	M22	1	1	4932480369	4058546406547
3/4" square	33	57	19.1	50	-	1	1	4932480370	4058546406554
3/4" square	34	57	20	51	-	1	1	4932480371	4058546406561
3/4" square	36	57	22.3	53.5	M24	1	1	4932480372	4058546406578
3/4" square	38	57	22.3	58	-	1	1	4932480373	4058546406585
3/4" square	39	57	21.5	58	-	1	1	4932480374	4058546406592
3/4" square	41	58	24.9	59.5	M27	1	1	4932480375	4058546406608
3/4" square	46	62	28.6	66.2	M30	1	1	4932480376	4058546406615
3/4" square	50	65	29.8	66.2	M33	1	1	4932480377	4058546406622

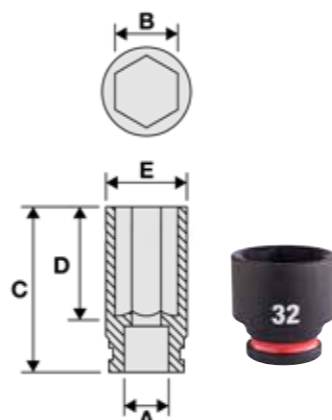

3/4" Socket Set

Description	Pack quantity	Min. order quantity	Article Number	EAN Code
① 3/4" Socket Set STD - 5 pc 3/4" STD socket: 27,30,32,33,36 + safety ring + blow molded BMC	5	1	4932498749	4058546526184
② 3/4" Socket Set deep - 5 pc 3/4" deep socket: 27,30,32,33,36 + safety ring + blow molded BMC	5	1	4932498750	4058546526191



3/4" SHOCKWAVE™ IMPACT DUTY impact sockets - deep

A (mm)	B (mm)	C (mm)	D (mm)	E (mm)	For anchor thread size	Pack quantity	Min. order quantity	Article Number	EAN Code
3/4" square	17	90	9.6	30	M10 (DIN)	1	1	4932480378	4058546406639
3/4" square	19	90	11.1	33	-	1	1	4932480379	4058546406646
3/4" square	21	90	11.7	35	M14	1	1	4932480380	4058546406653
3/4" square	22	90	12.5	36	-	1	1	4932480381	4058546406660
3/4" square	23	90	12.7	37.6	-	1	1	4932480382	4058546406677
3/4" square	24	90	13.9	38	M16	1	1	4932480383	4058546406684
3/4" square	25	90	14	40.5	-	1	1	4932480384	4058546406691
3/4" square	26	90	14.6	40.8	-	1	1	4932480385	4058546406707
3/4" square	27	90	15.8	41	M18	1	1	4932480386	4058546406714
3/4" square	28	90	16.3	45.2	-	1	1	4932480387	4058546406721
3/4" square	29	90	16.7	46	-	1	1	4932480388	4058546406738
3/4" square	30	90	16.7	46	M20	1	1	4932480389	4058546406745
3/4" square	31	90	17.8	47	-	1	1	4932480390	4058546406752
3/4" square	32	90	18.3	48	M22	1	1	4932480391	4058546406769
3/4" square	33	90	19.1	50	-	1	1	4932480392	4058546406776
3/4" square	34	90	20	51	-	1	1	4932480393	4058546406783
3/4" square	35	90	20.1	52	-	1	1	4932480394	4058546406790
3/4" square	36	90	22.3	53.5	M24	1	1	4932480395	4058546406806
3/4" square	37	90	20.4	54.8	-	1	1	4932480396	4058546406813
3/4" square	38	90	22.3	58	-	1	1	4932480397	4058546406820
3/4" square	39	90	21.5	58	-	1	1	4932480398	4058546406837
3/4" square	40	90	22.8	59.5	-	1	1	4932480399	4058546406844
3/4" square	41	90	24.9	59.5	M27	1	1	4932480400	4058546406851
3/4" square	46	90	28.6	66.2	M30	1	1	4932480401	4058546406868
3/4" square	50	90	29.8	72	M33	1	1	4932480402	4058546406875



3/4" SHOCKWAVE™ IMPACT DUTY Foam Inserts

Description	Pack quantity	Min. order quantity	Article Number	EAN Code
3/4" Sockets STD foam set (12pc)	12	1		
① SHOCKWAVE™ IMPACT DUTY 3/4" STD sockets: 22/24/27/30/32/33/36mm, extension 150mm, extension 250mm, adaptor 3/4" square --> 1/2" square, 3/4" swivel, adaptor 3/4" square --> 1" square, Foam with plastic base 417x355mm	12	1	4932493396	4058546482671
3/4" Sockets deep foam set 1-12pc	12	1		
② SHOCKWAVE™ IMPACT DUTY 3/4" deep sockets: 22/24/27/30/32/33/36mm, extension 150mm, extension 250mm, adaptor 3/4" square --> 1/2" square, 3/4" swivel, adaptor 3/4" square --> 1" square, Foam with plastic base 417x355mm	12	1	4932493398	4058546482695
Replacement foam with plastic base for 3/4" STD sockets. Size 417x355mm	1	1	4932493395	4058546482664
Replacement foam with plastic base for 3/4" deep sockets. Size 417x355mm	1	1	4932493397	4058546482688



3/4" impact sockets - extensions

Description	Total length (mm)	Pack quantity	Min. order quantity	Article Number	EAN Code
① 3/4" extension - 175 mm	175	1	1	4932480403	4058546406882
② 3/4" extension - 250 mm	250	1	1	4932480404	4058546406899

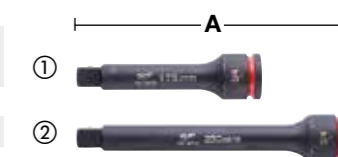

SHOCKWAVE™ IMPACT DUTY

SHOCKWAVE™ IMPACT DUTY

3/4" impact sockets - adaptors

Description	Total length (mm) A	Pack quantity	Min. order quantity	Article Number	EAN Code
① 3/4" to 1/2" SHOCKWAVE™ IMPACT DUTY adaptor	56.6	1	1	4932480405	4058546406905
② 3/4" to 1" SHOCKWAVE™ IMPACT DUTY adaptor	63	1	1	4932480406	4058546406912



3/4" SHOCKWAVE™ IMPACT DUTY universal joint

Description	Angle capacity	Pack quantity	Min. order quantity	Article Number	EAN Code
3/4" SHOCKWAVE™ IMPACT DUTY universal joint	25°	1	1	4932480407	4058546406929



3/4" impact sockets - security retaining ring

Description	Pack quantity	Min. order quantity	Article Number	EAN Code
3/4" impact sockets - security retaining ring	1	1	4932480450	4058546407353



1" SHOCKWAVE™ IMPACT DUTY impact sockets - standard

A (mm)	B (mm)	C (mm)	D (mm)	E (mm)	For anchor thread size	Pack quantity	Min. order quantity	Article Number	EAN Code
1" square	27	58	15.8	45.2	M18	1	1	4932480408	4058546406936
1" square	30	62	16.7	49	M20	1	1	4932480409	4058546406943
1" square	32	62	18.3	52	M22	1	1	4932480410	4058546406950
1" square	33	62	19.1	54	-	1	1	4932480411	4058546406967
1" square	34	62	20	54	-	1	1	4932480412	4058546406974
1" square	36	65	22.3	55.3	M24	1	1	4932480413	4058546406981
1" square	38	65	22.3	58	-	1	1	4932480414	4058546406998
1" square	41	70	24.9	61	M27	1	1	4932480416	4058546407018
1" square	42	70	25.4	64	-	1	1	4932480417	4058546407025
1" square	44	75	28.6	68	-	1	1	4932480950	4058546412357
1" square	46	75	28.6	68	M30	1	1	4932480418	4058546407032
1" square	50	75	29.8	73	M33	1	1	4932480419	4058546407049
1" square	55	83	33.6	82	M36	1	1	4932480420	4058546407056
1" square	60	87	35	86	M39	1	1	4932480421	4058546407063
1" square	65	90	35	92	M42	1	1	4932480422	4058546407070
1" square	70	93	35	97	M45	1	1	4932480423	4058546407087

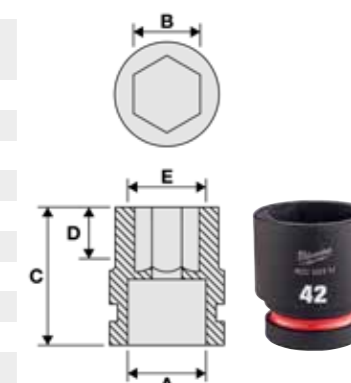

SHOCKWAVE™ IMPACT DUTY

SHOCKWAVE™ IMPACT DUTY

1" SHOCKWAVE™ IMPACT DUTY impact sockets - deep

A (mm)	B (mm)	C (mm)	D (mm)	E (mm)	For anchor thread size	Pack quantity	Min. order quantity	Article Number	EAN Code
1" square	27	92	15.8	45.2	M18	1	1	4932480424	4058546407094
1" square	30	92	16.7	49	M20	1	1	4932480425	4058546407100
1" square	32	92	18.3	52	M22	1	1	4932480426	4058546407117
1" square	33	92	19.1	54	-	1	1	4932480427	4058546407124
1" square	34	92	20	54	-	1	1	4932480428	4058546407131
1" square	36	92	22.3	55.3	M24	1	1	4932480429	4058546407148
1" square	38	92	22.3	58	-	1	1	4932480430	4058546407155
1" square	39	92	22.8	59	-	1	1	4932480431	4058546407162
1" square	41	100	24.9	61	M27	1	1	4932480432	4058546407179
1" square	46	100	28.6	68	M30	1	1	4932480434	4058546407193
1" square	50	100	28.6	73	M33	1	1	4932480435	4058546407209
1" square	55	100	33.6	82	M36	1	1	4932480436	4058546407216
1" square	60	120	35	86	M39	1	1	4932480437	4058546407223
1" square	65	125	35	92	M42	1	1	4932480438	4058546407230

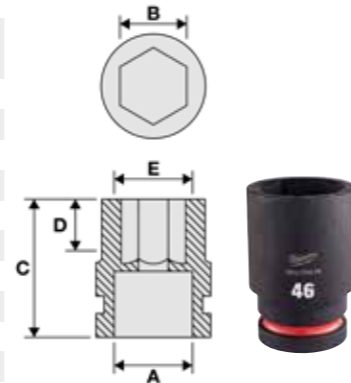

1" impact sockets - adaptor

Description	Total length (mm)	Pack quantity	Min. order quantity	Article Number	EAN Code
1" to 3/4" SHOCKWAVE™ IMPACT DUTY adaptor	70	1	1	4932480442	4058546407278



1" SHOCKWAVE™ IMPACT DUTY universal joint

Description	Angle capacity	Pack quantity	Min. order quantity	Article Number	EAN Code
1" SHOCKWAVE™ IMPACT DUTY universal joint	25°	1	1	4932480443	4058546407285



1" Socket Set

Description	Pack quantity	Min. order quantity	Article Number	EAN Code
① 1" Socket Set STD - 5 pc 1" STD socket: 27,30,32,33,36 + safety ring + blow molded BMC	5	1	4932498751	4058546526207
② 1" Socket Set deep - 5 pc 1" deep socket: 27,30,32,33,36 + safety ring + blow molded BMC	5	1	4932498752	4058546526214



1" impact sockets - security retaining rings

Description	Pack quantity	Min. order quantity	Article Number	EAN Code
1" retaining ring for 27 - 44mm sockets	1	1	4932480451	4058546407360
1" retaining ring for 46 - 70mm sockets	1	1	4932480452	4058546407377



Railway Sockets

SHOCKWAVE™ IMPACT DUTY steel (Chrome-Molybdenum) is high quality alloy steel which provides ultimate strength and durability.

A (mm)	B (mm)	C (mm)	D (mm)	E (mm)	Article Number	EAN Code
1" square	21x28	70	24	56	4932499124	4058546529932
1" square	21x28	110	24	56	4932499125	4058546529949
1" square	22x29	70	24	58	4932499126	4058546529956
① 1" square	22x29	110	24	58	4932499127	4058546529963
1" square	21x24,5	70	24	54	4932499128	4058546529970
1" square	21x24,5	110	24	54	4932499129	4058546529987
② 1" square	Bi-Square 1-11/16"	70	25	82	4932499146	4058546530150
1" square	Bi-Square 1-1/8"	70	18	54	4932499148	4058546530174



Impact sockets - rails & clips

Flexible interchangeable rails and clips for customisation of 1/4", 3/8", and 1/2" drive sockets. Compatible with standard and deep sockets, removable end caps for easy clip removal. Metal ball detent clip for superior socket retention. Usable with impact and chrome sockets. Holes in rail are on top and on the bottom for easy mounting.



Description	Length (mm)	Pack quantity	Min. order quantity	Article Number	EAN Code
1/4" impact socket rail	350	1	1	4932480444	4058546407292
1/4" extra rail clips - 10pcs	-	10	1	4932480445	4058546407308
3/8" impact socket rail	350	1	1	4932480446	4058546407315
3/8" extra rail clips - 10pcs	-	10	1	4932480447	4058546407322
1/2" impact socket rail	350	1	1	4932480448	4058546407339
1/2" extra rail clips - 10pcs	-	10	1	4932480449	4058546407346

1" impact sockets - extensions

Description	Total length (mm)	Pack quantity	Min. order quantity	Article Number	EAN Code
① 1" extension - 175 mm	175	1	1	4932480440	4058546407254
② 1" extension - 250 mm	250	1	1	4932480441	4058546407261





NAILS & STAPLES

Arm yourself for any carpentry and construction project with professional-grade nails & staples from MILWAUKEE®

FIND YOUR PERFECT FIT WITH OUR TOOL CONFIGURATOR



Brad nails, 18 gauge, thin finish head

Suitable for M18 FN18GS
Collated straight strip



Wire gauge	Dimensions (Outer)(H x W x D / mm)	Total length (mm)	Nail angle	Service class	Material	Pack quantity	Min. order quantity	Article Number	EAN Code
18	1.05 x 1.25	16	0°	1	Resin Coated. Galvanised	10.000	1	4932492549	4058546419165
18	1.05 x 1.25	19	0°	1	Resin Coated. Galvanised	10.000	1	4932492550	4058546419172
18	1.05 x 1.25	25	0°	1	Resin Coated. Galvanised	5.000	1	4932492551	4058546419189
18	1.05 x 1.25	30	0°	1	Resin Coated. Galvanised	5.000	1	4932492552	4058546419196
18	1.05 x 1.25	32	0°	1	Resin Coated. Galvanised	5.000	1	4932492553	4058546419202
① 18	1.05 x 1.25	35	0°	1	Resin Coated. Galvanised	5.000	1	4932498743	4058546526122
18	1.05 x 1.25	38	0°	1	Resin Coated. Galvanised	5.000	1	4932498744	4058546526139
18	1.05 x 1.25	40	0°	1	Resin Coated. Galvanised	5.000	1	4932492554	4058546419219
18	1.05 x 1.25	45	0°	1	Resin Coated. Galvanised	5.000	1	4932492555	4058546419226
18	1.05 x 1.25	50	0°	1	Resin Coated. Galvanised	5.000	1	4932492556	4058546419233
18	1.05 x 1.25	16	0°	3	Stainless / Rust free	10.000	1	4932492557	4058546419240
18	1.05 x 1.25	19	0°	3	Stainless / Rust free	10.000	1	4932492558	4058546419257
18	1.05 x 1.25	25	0°	3	Stainless / Rust free	5.000	1	4932492559	4058546419264
18	1.05 x 1.25	30	0°	3	Stainless / Rust free	5.000	1	4932492560	4058546419271
② 18	1.05 x 1.25	32	0°	3	Stainless / Rust free	5.000	1	4932492561	4058546419288
18	1.05 x 1.25	35	0°	3	Stainless / Rust free	5.000	1	4932498745	4058546526146
18	1.05 x 1.25	38	0°	3	Stainless / Rust free	5.000	1	4932498746	4058546526153
18	1.05 x 1.25	40	0°	3	Stainless / Rust free	5.000	1	4932492562	4058546419295
18	1.05 x 1.25	45	0°	3	Stainless / Rust free	5.000	1	4932492563	4058546419301
18	1.05 x 1.25	50	0°	3	Stainless / Rust free	5.000	1	4932492564	4058546419318

Finish nails, 15 gauge, 34°, D Head

Suitable for M18 CN15GA, M18 FN15GA
Collated angled strip



Wire gauge	Dimensions (Outer)(H x W x D / mm)	Total length (mm)	Nail angle	Service class	Material	Pack quantity	Min. order quantity	Article Number	EAN Code
15	1.8	32	34°	1	Galvanised	4.000	1	4932492574	4058546419417
15	1.8	38	34°	1	Galvanised	2.500	1	4932492575	4058546419424
① 15	1.8	44	34°	1	Galvanised	2.500	1	4932492576	4058546419431
15	1.8	50	34°	1	Galvanised	2.500	1	4932492577	4058546419448
15	1.8	63	34°	1	Galvanised	2.200	1	4932492578	4058546419455
15	1.8	38	34°	3	Stainless / Rust free	2.500	1	4932492579	4058546419462
② 15	1.8	50	34°	3	Stainless / Rust free	2.500	1	4932492580	4058546419479
15	1.8	63	34°	3	Stainless / Rust free	2.200	1	4932492581	4058546419486

Finish nails, 16 gauge, 20°, thin finish head

Suitable for M18 CN16GA, M18 FN16GA
Collated angled strip



Wire gauge	Dimensions (Outer)(H x W x D / mm)	Total length (mm)	Nail angle	Service class	Material	Pack quantity	Min. order quantity	Article Number	EAN Code
16	1.35 x 1.61	32	20°	1	Galvanised	2,000	1	4932492582	4058546419493
16	1.35 x 1.61	38	20°	1	Galvanised	2,000	1	4932492583	4058546419509
16	1.35 x 1.61	45	20°	1	Galvanised	2,000	1	4932492584	4058546419516
16	1.35 x 1.61	50	20°	1	Galvanised	2,000	1	4932492585	4058546419523
16	1.35 x 1.61	64	20°	1	Galvanised	2,000	1	4932492586	4058546419530

Finish nails, 16 gauge, 0° straight, thin finish head

Suitable for M18 FN16GS
Collated straight strip



Wire gauge	Dimensions (Outer)(H x W x D / mm)	Total length (mm)	Nail angle	Service class	Material	Pack quantity	Min. order quantity	Article Number	EAN Code
16	1.60	25	0°	1	Galvanised	5,000	1	4932498312	4058546521813
16	1.60	32	0°	1	Galvanised	5,000	1	4932498313	4058546521820
16	1.60	38	0°	1	Galvanised	2,500	1	4932498314	4058546521837
16	1.60	45	0°	1	Galvanised	2,500	1	4932498315	4058546521844
16	1.60	50	0°	1	Galvanised	5,000	1	4932498316	4058546521851
16	1.60	63	0°	1	Galvanised	2,500	1	4932498317	4058546521868

Framing nails, 20°, round head

Suitable for M18 FFN21
Collated angled strip



Shank diameter (mm)	Total length (mm)	Nail angle	Service class	Material	Pack quantity	Min. order quantity	Article Number	EAN Code
2.8	65	20°	1	Ring Shank, Bright	2,000	1	4932492587	4058546419547
2.8	75	20°	1	Ring Shank, Bright	2,000	1	4932492588	4058546419554
3.1	80	20°	1	Ring Shank, Bright	1,750	1	4932492589	4058546419561
3.1	90	20°	1	Ring Shank, Bright	1,750	1	4932492590	4058546419578
2.8	65	20°	2	Ring Shank, Galvanised	2,000	1	4932492591	4058546419585
3.1	75	20°	2	Ring Shank, Galvanised	1,750	1	4932492592	4058546419592
3.1	80	20°	2	Ring Shank, Galvanised	1,750	1	4932492593	4058546419608
3.1	90	20°	2	Ring Shank, Galvanised	1,750	1	4932492594	4058546419615

Framing nails, 34°, D head

Suitable for M18 FFN
Paper collated angled strip

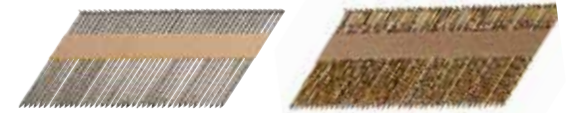

Shank diameter (mm)	Total length (mm)	Nail angle	Service class	Material	Pack quantity	Min. order quantity	Article Number	EAN Code
2.8	50	34°	1	Smooth Shank, Bright	2,200	1	4932492595	4058546419622
2.8	63	34°	1	Smooth Shank, Bright	2,200	1	4932492596	4058546419639
2.8	75	34°	1	Smooth Shank, Bright	2,200	1	4932492597	4058546419646
3.1	90	34°	1	Smooth Shank, Bright	2,200	1	4932492598	4058546419653
2.8	50	34°	1	Ring Shank, Bright	2,200	1	4932492599	4058546419660
2.8	63	34°	1	Ring Shank, Bright	2,200	1	4932492600	4058546419677
2.8	70	34°	1	Ring Shank, Bright	2,200	1	4932492601	4058546419684
2.8	75	34°	1	Ring Shank, Bright	2,200	1	4932492602	4058546419691
2.8	80	34°	1	Ring Shank, Bright	2,200	1	4932492603	4058546419707
3.1	90	34°	1	Ring Shank, Bright	2,200	1	4932492604	4058546419714
3.1	90	34°	2	Smooth shank, Galvanised	2,200	1	4932492605	4058546419721
2.8	50	34°	2	Ring Shank, Galvanised	2,200	1	4932492606	4058546419738
2.8	63	34°	2	Ring Shank, Galvanised	2,200	1	4932492607	4058546419745
2.8	75	34°	2	Ring Shank, Galvanised	2,200	1	4932492608	4058546419752
3.1	63	34°	2	Ring Shank, Galvanised	2,200	1	4932492609	4058546419769
3.1	75	34°	2	Ring Shank, Galvanised	2,200	1	4932492610	4058546419776
3.1	80	34°	2	Ring Shank, Galvanised	2,200	1	4932492611	4058546419783
3.1	90	34°	2	Ring Shank, Galvanised	2,200	1	4932492612	4058546419790
2.8	50	34°	3	Ring Shank, Hot Dipped Galvanised	2,200	1	4932492613	4058546419806
2.8	65	34°	3	Ring Shank, Hot Dipped Galvanised	2,200	1	4932492614	4058546419813
3.1	90	34°	3	Ring Shank, Hot Dipped Galvanised	2,200	1	4932492615	4058546419820

21° Duplex Nails

Double Head, for temporary nailing and easier removal.

Smooth shank, for easier removal.

Used in temporary construction, such as concrete forms where nail removal is required.



Shank diameter (mm)	Total length (mm)	Nail angle	Pack quantity	Min. order quantity	Article Number	EAN Code
3.3	73	21°	2000	1	4932498155	4058546513153
3.3	92	21°	2000	1	4932498156	4058546513160



Staples

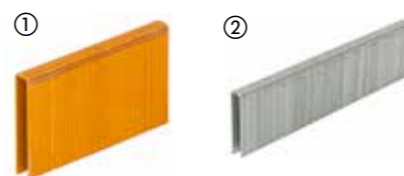

Type	Width (mm)	Dimensions (Outer)(H x W x D / mm)	Total length (mm)	Service class	Material	Pack quantity	Min. order quantity	Article Number	EAN Code
① Fine wire staples for M12BST	10.6	0.5 x 1.25	6	1	Galvanised	1.400	1	4932492565	4058546419325
	10.6	0.5 x 1.25	6	1	Galvanised	5.000	1	4932492570	4058546419370
	10.6	0.5 x 1.25	8	1	Galvanised	1.000	1	4932492566	4058546419332
	10.6	0.5 x 1.25	8	1	Galvanised	5.000	1	4932492571	4058546419387
	10.6	0.5 x 1.25	10	1	Galvanised	900	1	4932492567	4058546419349
	10.6	0.5 x 1.25	10	1	Galvanised	5.000	1	4932492572	4058546419394
	10.6	0.5 x 1.25	12	1	Galvanised	750	1	4932492568	4058546419356
	10.6	0.5 x 1.25	14	1	Galvanised	600	1	4932492569	4058546419363
	10.6	0.5 x 1.25	14	1	Galvanised	5.000	1	4932492573	4058546419400
② Fine wire staples for M18 FNCST18GS	5.7	1.05 x 1.25	15	1	Resin Coated, Galvanised	7.200	1	4932492616	4058546419837
	5.7	1.05 x 1.25	20	1	Resin Coated, Galvanised	6.000	1	4932492617	4058546419844
	5.7	1.05 x 1.25	25	1	Resin Coated, Galvanised	4.400	1	4932492618	4058546419851
	5.7	1.05 x 1.25	30	1	Resin Coated, Galvanised	4.200	1	4932492619	4058546419868
	5.7	1.05 x 1.25	32	1	Resin Coated, Galvanised	3.600	1	4932492620	4058546419875
	5.7	1.05 x 1.25	35	1	Resin Coated, Galvanised	3.600	1	4932492621	4058546419882
	5.7	1.05 x 1.25	36	1	Resin Coated, Galvanised	3.600	1	4932492622	4058546419899
	5.7	1.05 x 1.25	38	1	Resin Coated, Galvanised	2.600	1	4932492623	4058546419905
	5.7	1.05 x 1.25	25	3	Stainless, Resin Coated	4.400	1	4932492624	4058546419912
	5.7	1.05 x 1.25	35	3	Stainless, Resin Coated	3.600	1	4932492625	4058546419929
	5.7	1.05 x 1.25	38	3	Stainless, Resin Coated	2.600	1	4932492626	4058546419936

Staples - fencing

Fencing staples for the Milwaukee M18 FFUS.

For all types of wire fencing attached to wood ie. livestock fencing, square/chain/barbed wire and high tensile wire.

Hot dipped galvanised coating for superior long term corrosion resistance.

4mm thick steel wire for best lifetime in outdoor applications.

Sharp divergent point tips – the staple point tip twists as it is driven into the wood giving better holding power.

Red adhesive coating for increased drivability while maximizing holding power.

Paper tape collation for speed and convenience.



Total length (mm)	Width (mm)	Service class	Pack quantity	Min. order quantity	Article Number	EAN Code
40	20	3	960	1	4932480358	4058546406431
45	20	3	960	1	4932480359	4058546406448
50	20	3	960	1	4932480360	4058546406455

Roofing coil nails, 15°

15° Round Head Nails.

15° Wire Coil Collation.

Designed for fastening in roofing and facade work, ideal for fast driving and superior holding.

Suitable for M18 FRCN45.



Shank diameter (mm)	Length (mm)	Nail angle	Service class	Material	Pack quantity	Min. order quantity	Article Number	EAN Code
3,05	19	15°	2	Ring shank, Galvanised	2880	1	4932499310	4058546564742
3,05	22	15°	2	Ring shank, Galvanised	2880	1	4932499311	4058546564759
3,05	25	15°	2	Ring shank, Galvanised	2160	1	4932499312	4058546564766
3,05	32	15°	2	Ring shank, Galvanised	2160	1	4932499313	4058546564773
3,05	38	15°	2	Ring shank, Galvanised	1440	1	4932499314	4058546564780
3,05	45	15°	2	Ring shank, Galvanised	1440	1	4932499315	4058546564797
3,05	22	15°	2	Smooth shank, Galvanised	2880	1	4932499316	4058546564803
3,05	25	15°	2	Smooth shank, Galvanised	2160	1	4932499317	4058546564810
3,05	32	15°	2	Smooth shank, Galvanised	2160	1	4932499318	4058546564827
3,05	19	15°	3	Ring shank, Hot Dipped Galvanised	2880	1	4932499319	4058546564834
3,05	22	15°	3	Rig shank, Hot Dipped Galvanised	2880	1	4932499320	4058546564841
3,05	25	15°	3	Ring shank, Hot Dipped Galvanised	2160	1	4932499321	4058546564858
3,05	32	15°	3	Ring shank, Hot Dipped Galvanised	2160	1	4932499322	4058546564865
3,05	38	15°	3	Ring shank, Hot Dipped Galvanised	1440	1	4932499323	4058546564872
3,05	45	15°	3	Ring shank, Hot Dipped Galvanised	1440	1	4932499324	4058546564889
3,05	25	15°	3	Smooth shank, Hot Dipped Galvanised	2160	1	4932499325	4058546564896
3,05	32	15°	3	Smooth shank, Hot Dipped Galvanised	2160	1	4932499326	4058546564902
3,05	25	15°	3	Ring shank, Stainless Steel	2160	1	4932499327	4058546564919
3,05	32	15°	3	Ring shank, Stainless Steel	2160	1	4932499328	4058546564926

Staples - electrical cable

Cable staples for the Milwaukee M12 BCST

19mm wide 25mm long staples for fixing all types of electrical/ data cable to wooden joists / structures. Not suitable for fixing to concrete.

Flat top staple with a plastic bridge on the inside. The plastic bridge ensures cables will not be damaged or cut when fixed.

Suitable only for internal use.



Total length (mm)	Width (mm)	Service class	Pack quantity	Min. order quantity	Article Number	EAN Code
25	19	1	600	1	4932479628	4058546374228



SAWZALL™

BLADE SELECTION GUIDE

1. Identify the material to be cut in the rows below.
2. Follow the row across to find best/compatible performance.

BEST PERFORMANCE

GOOD PERFORMANCE



	TPI	BLADE THICKNESS (MM)	THICK METAL > 4MM	MEDIUM METAL 1.5 - 4MM	THIN METAL 0.5 - 3MM	STAINLESS STEEL	CAST IRON	NON FERROUS METALS (CU/AL)	WOOD	GREEN WOOD	WOOD WITH NAILS & SCREWS	PALLETS	PVC Pipe
DEMOLITION BLADES													
AX™ CARBIDE		5	1.27										
AX™		5	1.27										
THIN KERF		5	1.27										
METAL CUTTING BLADES													
TORCH™ NITRUS CARBIDE		8	1.27										
		10	1.27										
TORCH™ CARBIDE		8	1.27										
		10	1.27										
TORCH™		10	1.10	Faster/Rougher	Faster/Rougher								
		14	1.10	↓	↓								
		18	1.10	Slower/Smother	Slower/Smother								
THIN KERF		14	0.90	Faster/Rougher	Faster/Rougher								
		18	0.90	↓	↓								
		25	0.90	Slower/Smother	Slower/Smother								
UNIVERSAL BLADES													
WRECKER™ NITRUS CARBIDE		6	1.27										
WRECKER™ CARBIDE		6	1.27										
WRECKER™		7/11	1.60										
Art. Nr. 48005092		10	0.90										
Art. Nr. 48005293		10/14	0.90										
Art. Nr. 48005093		8/12	1.27										
WOOD CUTTING BLADES													
Art. Nr. 48001075		4.2	1.27										
Art. Nr. 48001077		5.5/6	1.27										
Art. Nr. 48001079		8.5	1.27										
SPECIAL APPLICATION BLADES													
DIAMOND GRIT		GRIT	1.10										

NITRUS CARBIDE™

TORCH™
NITRUS CARBIDE

WRECKER™
NITRUS CARBIDE

CUT TOUGHER

Our SAWZALL™ The TORCH™ with NITRUS CARBIDE™ for CAST IRON and other thick metals is the next generation of carbide teeth technology. The blade delivers 3X the life of existing carbide teeth reciprocating saw blades to continuously make the toughest cast iron removals on the job.

*vs standard Carbide blades

Our WRECKER™ with NITRUS CARBIDE™ SAWZALL® blade for multi-material cutting features a 6TPI design for best material versatility and the ability to cut materials from wood with nails and screws to thick metals. Our blade delivers 2x life versus carbide teeth blades eliminating the need for blade changes when cutting a variety of materials.



CARBIDE TEETH

CUT LONGER. CUT MORE. CUT FASTER.



THE TORCH™
CARBIDE TEETH



AX™
CARBIDE TEETH



THE WRECKER™
CARBIDE TEETH

x50
LONGER LIFE

This blade delivers up to 50X life over bi-metal standard blades

1000
MORE CUTS

The Ax with Carbide Teeth is optimized for Cordless Recip Saws delivering over 25% more cuts per charge

x2
FASTER CUTS

This blade delivers up to 2X faster cuts than bi-metal standard blades

Metal: Heavy duty TORCH™ with NITRUS CARBIDE™

The TORCH™ blades with NITRUS CARBIDE™ teeth is the next generation of carbide technology. This special carbide NITRUS blend is designed to cut 3x longer than existing standard carbide teeth blades. The tooth design ensures fast starts and smooth cuts, large gullets for easy chip ejection. The TORCH™ Blades with NITRUS CARBIDE™ are designed to last the longest and cut the fastest in cast iron/ SML pipe, stainless steel and other metals. Thick 1.27 mm robust blade body for precise straight cuts. 25 mm blade height for improved stability and minimum vibration. Best performance in all metals, especially in stainless steel and cast iron soil, waste and drainage pipes.

Blade length (mm)	Tooth pitch (mm)	Teeth per inch	Ref. No.							Pack quantity	Min. order quantity	Article Number	EAN Code
150	2.5	10	S955HHM	3 - 11	Ø 10 - 100	3 - 11	Ø 10 - 100	3 - 11	Yes	5	1	48476251 48476551	045242367726 045242367849
230	2.5	10	S1155HHM	3 - 11	Ø 10 - 175	3 - 11	Ø 10 - 175	3 - 11	Yes	5	1	48476252 48476552	045242367801 045242367771
300	2.5	10	S1255HHM	3 - 11	Ø 10 - 250	3 - 11	Ø 10 - 250	3 - 11	Yes	5	1	48476253 48476553	045242367757 045242367832
150	3.2	8	S955CHC	5 - 14	Ø 10 - 100	5 - 14	Ø 10 - 100	5 - 14	Yes	5	1	48475261 48475561	045242368495 045242368877
230	3.2	8	S1155CHC	5 - 14	Ø 10 - 175	5 - 14	Ø 10 - 175	5 - 14	Yes	5	1	48475262 48475562	045242368501 045242368884
300	3.2	8	S1255CHC	5 - 14	Ø 10 - 250	5 - 14	Ø 10 - 250	5 - 14	Yes	5	1	48475263 48475563	045242368518 045242368891

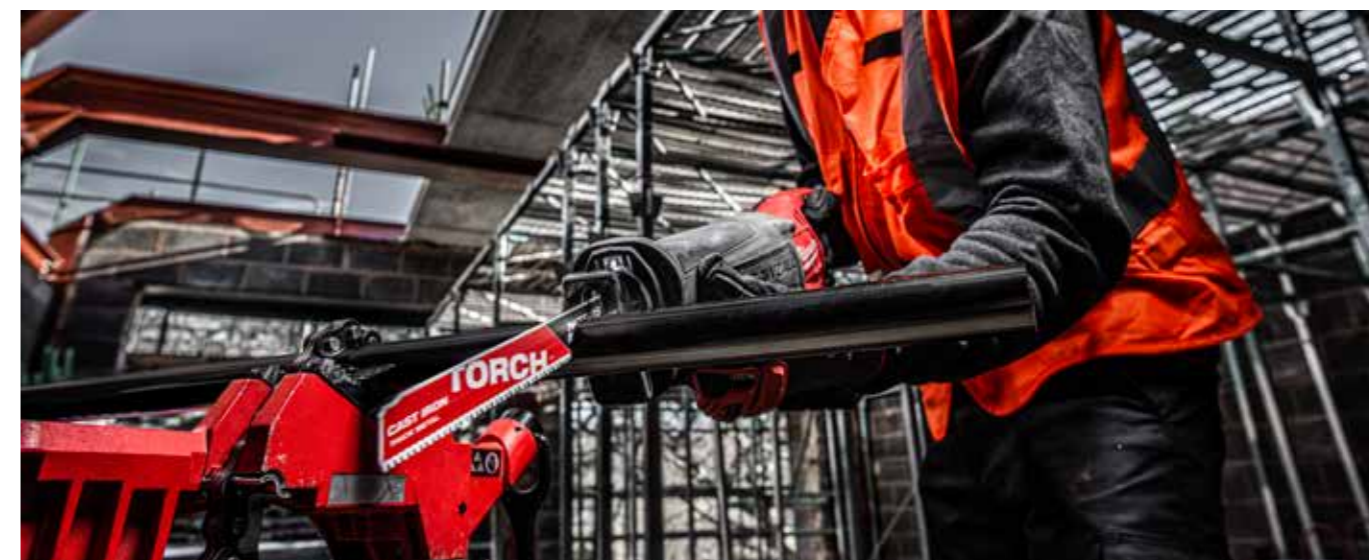

Metal: Heavy duty TORCH™ carbide teeth

Carbide teeth provide for longest life in metals - up to 50x more life compared to Bi-Metal blades
Thick 1.27 mm robust blade body for precise straight cuts
25 mm blade height for improved stability and minimum vibration
Best for cast iron and all thick metal demolition



Blade length (mm)	Tooth pitch (mm)	Teeth per inch	Ref. No.						Pack quantity	Min. order quantity	Article Number	EAN Code
150	2.5	10	S955HHM	3 - 11	Ø 10 - 100	3 - 11	Ø 10 - 100	3 - 11	Yes	1	48475251	045242368464
										5	48475551	045242368846
230	2.5	10	S1155HHM	3 - 11	Ø 10 - 175	3 - 11	Ø 10 - 175	3 - 11	Yes	1	48475252	045242368471
										5	48475552	045242368853
300	2.5	10	S1255HHM	3 - 11	Ø 10 - 250	3 - 11	Ø 10 - 250	3 - 11	Yes	1	48475253	045242368488
										5	48475553	045242368860
150	3.2	8	S955CHC	5 - 14	Ø 10 - 100	5 - 14	Ø 10 - 100	5 - 14	Yes	1	48475201	045242368341
										5	48475501	045242368754
230	3.2	8	S1155CHC	5 - 14	Ø 10 - 175	5 - 14	Ø 10 - 175	5 - 14	Yes	1	48475202	045242368358
										5	48475502	045242368761
300	3.2	8	S1255CHC	5 - 14	Ø 10 - 250	5 - 14	Ø 10 - 250	5 - 14	Yes	1	48475203	045242368365
										5	48475503	045242368778



Metal: Heavy duty TORCH™ demolition blades

THE TORCH™

STIFFEST

GRID IRON™

LONGEST

2X LIFE*

STRONGEST

TOUGH NECK

DOUBLE DUTY UPGRADE™

Improved tooth geometry for best speed and double the lifetime. Thick 1.06 mm robust blade body for precise cuts. 25 mm blade height for improved stability and minimum vibration. Bi-Metal quality cutting teeth with 8% cobalt the ultimate in performance and lifetime.

TOUGH NECK

Stamped indentations around the reception strengthens the blade at its weakest point.

GRID IRON™

A grid iron pattern is built into the blade to make it more rigid with less tendency to bend or buckle for best durability and straight cuts.

Metal: Heavy duty TORCH™ demolition blades

Blade length (mm)	Tooth pitch (mm)	Teeth per inch	Ref. No.								Pack quantity	Min. order quantity	Article Number	EAN Code	
150	1.4	18	S926BEF/ SS927BEF	1.5 - 8	Ø 10 - 100	1.5 - 8	-	1.5 - 4	Yes	5	1	25	1	48475784 48008784	045242369034 045242082407
230	1.4	18	S1126BEF/ S1127BEF	1.5 - 8	Ø 10 - 175	1.5 - 8	-	1.5 - 4	Yes	5	1	25	1	48475788 48008788	045242369065 045242082421
300	1.4	18	S1226BEF/ S1227BEF	1.5 - 8	Ø 10 - 250	1.5 - 8	-	1.5 - 4	Yes	5	1	25	1	48475789 48008789	045242369072 045242082438
150	1.8	14	S926BEF/ SS927BEF	3 - 11	Ø 10 - 100	3 - 11	-	3 - 7	Yes	5	1	25	1	48475782 48008782	045242369027 045242082391
230	1.8	14	S1126BEF/ S1127BEF	3 - 11	Ø 10 - 175	3 - 11	-	3 - 7	Yes	5	1	25	1	48475787 48008787	045242369058 045242082414
150	2.5	10	S926CHF/ S936CHF	5 - 14	Ø 10 - 100	5 - 14	Ø 10 - 100	5 - 10	Yes	5	1	25	1	48475712 48008712	045242368990 045242082377
230	2.5	10	S1226CHF/ S1136CHF	5 - 14	Ø 10 - 175	5 - 14	Ø 10 - 175	5 - 10	Yes	5	1	25	1	48475713 48008713	045242369003 045242082384
300	2.5	10	S1226CHF	4 - 10	Ø 10 - 180	4 - 10	Ø 10 - 250	5 - 10	Yes	5	1	5	1	48475714	045242369010

Metal: THIN KERF blades

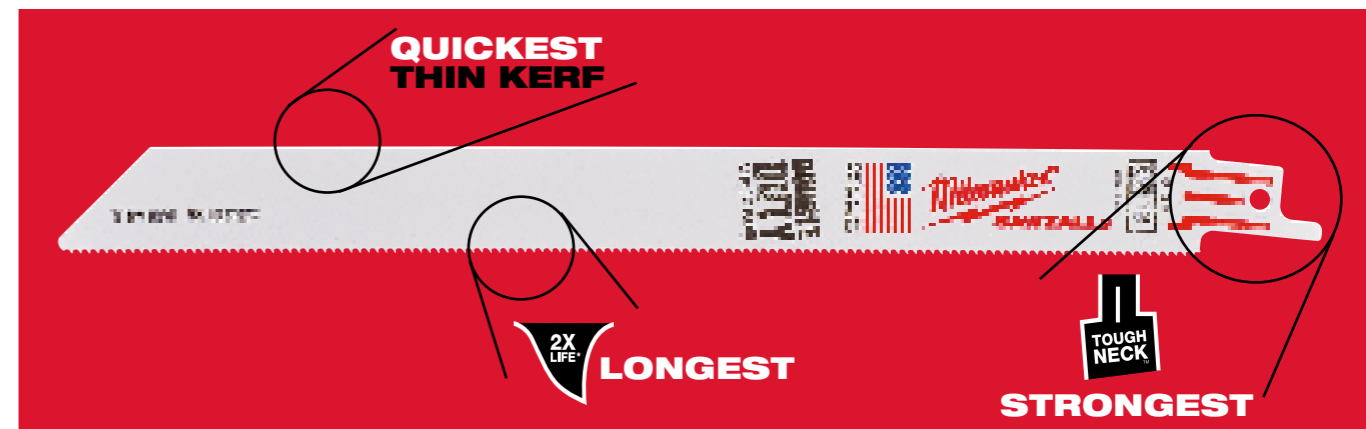

Blade length (mm)	Tooth pitch (mm)	Teeth per inch	Ref. No.									Pack quantity	Min. order quantity	Article Number	EAN Code	
100	1	24	S522AF	0.5 - 3	-	Ø 8 - 50	0.5 - 3	0.5 - 1.5	No	No	5	1	5	1	48475185	045242368273
150	1	24	S918AF/ S922AF	0.5 - 3	-	Ø 8 - 100	0.5 - 3	0.5 - 1.5	No	No	5	1	5	1	48475186	045242368280
100	1.4	18	S522EF	1.5 - 8	-	Ø 10 - 50	1.5 - 8	1.5 - 4	No	No	5	1	5	1	48475183	045242368259
150	1.4	18	S922EF	1.5 - 8	-	Ø 10 - 100	1.5 - 8	1.5 - 4	No	No	5	1	50	1	48475184 48016184	045242368266 045242084739
230	1.4	18	S1122EF	1.5 - 8	-	Ø 10 - 175	1.5 - 8	1.5 - 4	No	No	5	1	50	1	48475188 48016188	045242368303 045242084876
300	1.4	18	-	1.5 - 8	-	Ø 10 - 250	1.5 - 8	1.5 - 4	No	Yes	5	1	50	1	48475189 48016189	045242368310 045242084883
90	1.8	14	S422BF	1.5 - 6	-	-	1.5 - 4	-	Yes	No	5	1	5	1	48475162	045242368211
100	1.8	14	S522BF	3 - 11	-	Ø 10 - 50	3 - 11	3 - 7	No	No	5	1	5	1	48475181	045242368235
150	1.8	14	S922BF	3 - 11	-	Ø 10 - 100	3 - 11	3 - 7	No	No	5	1	50	1	48475182 48016182	045242368242 045242084722
230	1.8	14	S1122BF	3 - 11	-	Ø 10 - 175	3 - 11	3 - 7	No	No	5	1	50	1	48475187 48016187	045242368297 045242084869

*vs. standard Bi Metal blades



Wood with nails: Heavy duty AX™ carbide teeth demolition blades



Up to 50x longer life than standard Bi-Metal blades. Carbide teeth deliver long life and extreme durability in the toughest applications. Cuts through hardened screws and fasteners.
 Up to 2x faster than standard Bi-Metal blades. A fast and aggressive 5 Tpi tooth pattern allows for the fastest cutting in nail embedded wood and a wide range of construction materials (wood/nails/bolts/screws/cast iron/asphalt roofing felt shingles).
 Up to 25% more cuts per charge vs. standard Bi-Metal blades. Optimised for use with cordless reciprocating saws.
FANG TIP™: For faster plunge cutting and reaching into restricted areas.
NAIL GUARD™: Protects the tooth during nail impacts for increased durability and lifetime.
 Sloped shape: Excellent for plunge cutting and reaching into restricted areas.
 Thick 1.27 mm robust blade body for precise straight cuts.
 25 mm blade height for improved stability and minimum vibration.
 Best for wood / nails / hardened fasteners demolition

Blade length (mm)	Tooth pitch (mm)	Teeth per inch	Ref. No.	Image 1	Image 2	Image 3	Image 4	Image 5	Image 6	Image 7	Pack quantity	Min. order quantity	Article Number	EAN Code
150	5	5	S967XHM	10 - 100	10 - 100	Ø 10 - 100	Yes	Yes	Yes	Yes	1	1	48475221	045242368372
											5	1	48475521	045242368785
230	5	5	S1167XHM	10 - 175	10 - 175	Ø 10 - 175	Yes	Yes	Yes	Yes	1	1	48475226	045242368389
											5	1	48475526	045242368792
300	5	5	S1267XHM	10 - 250	10 - 250	Ø 10 - 250	Yes	Yes	Yes	Yes	1	1	48475227	045242368396
											5	1	48475527	045242368808

Wood with nails: Heavy duty AX™ demolition blades



FANG TIP™: For faster plunge cutting and reaching into restricted areas.
NAIL GUARD™: Protects the tooth during nail impacts for increased durability and lifetime.
Strong: Thick 1.27mm blade body and 25mm height for maximum robustness and life making it ideal for wood with nails or bolts.
Fast: Aggressive 5 Tpi tooth geometry removes more material per stroke for faster cutting.
Sloped shape: Excellent for plunge cutting and reaching into restricted areas.
Shatter resistant: Bi-Metal construction allows the blade to bend and flex without breaking.

Blade length (mm)	Tooth pitch (mm)	Teeth per inch	Ref. No.	Image 1	Image 2	Image 3	Image 4	Image 5	Image 6	Image 7	Pack quantity	Min. order quantity	Article Number	EAN Code
150	5	5	S610VF	10 - 100	10 - 100	Ø 10 - 100	Yes	Yes	Yes	Yes	5	1	48475021	045242368082
											25	1	48008021	045242082285
230	5	5	S1110VF	10 - 175	10 - 175	Ø 10 - 175	Yes	Yes	Yes	Yes	5	1	48475026	045242368099
											25	1	48008026	045242082292
300	5	5	S1210VF	10 - 250	10 - 250	Ø 10 - 250	Yes	Yes	Yes	Yes	5	1	48475027	045242368105
											25	1	48008027	045242082308

Wood with nails: THIN KERF demolition blades



FANG TIP™: For faster plunge cutting and reaching into restricted areas.
NAIL GUARD™: Protects the tooth during nail impacts for increased durability and lifetime.
Strong: 1.27 mm thick blade body and 19mm height for good strength and blade life making it ideal for wood with nails or bolts.
Fast: Aggressive 5 Tpi geometry removes more material per stroke for faster cutting.
Long sloped shape: Excellent for plunge cutting and reaching into restricted areas.
Shatter resistant: Bi-Metal construction allows the blade to bend and flex without breaking.

Blade length (mm)	Tooth pitch (mm)	Teeth per inch	Ref. No.	Image 1	Image 2	Image 3	Image 4	Image 5	Image 6	Image 7	Pack quantity	Min. order quantity	Article Number	EAN Code
150	5	5	S611DF	10 - 100	10 - 100	Ø 10 - 100	Yes	Yes	Yes	Yes	5	1	48475035	045242368112
											50	1	48016035	045242084791
230	5	5	S1111DF	10 - 175	10 - 175	Ø 10 - 175	Yes	Yes	Yes	Yes	5	1	48475036	045242368129
											50	1	48016036	045242084661
300	5	5	S1411DF	10 - 250	10 - 250	Ø 10 - 250	Yes	Yes	Yes	Yes	5	1	48475037	045242368136
											50	1	48016037	045242084807

Multi Material: WRECKER™ with NITRUS CARBIDE™

NITRUS CARBIDE™ teeth technology: Offers up to 3X life vs. carbide teeth blades in multi-material applications or up to 100X life vs. standard bi-metal blades.

FANG TIP™: For faster plunge cutting and reaching into restricted areas.

Thick 1.27mm robust blade body for precise straight cuts.

25 mm blade height for improved stability and minimum vibration.

Best for multi material demolition (wood with nails or hardened fastners, cast iron and thick metal).



Blade length (mm)	Tooth pitch (mm)	Teeth per inch	Ref. No.								Pack quantity	Min. order quantity	Article Number	EAN Code
150	4.2	6	S956XHM	6 - 14	Ø 10 - 100	6 - 14	Ø 10 - 100	Yes	Yes	Yes	1	1	48475271	045242368525
											5	1	48475571	045242368907
230	4.2	6		6 - 14	Ø 10 - 175	6 - 14	Ø 10 - 175	Yes	Yes	Yes	1	1	48475272	045242368532
											5	1	48475572	045242368914
300	4.2	6		6 - 14	Ø 10 - 250	6 - 14	Ø 10 - 250	Yes	Yes	Yes	1	1	48475273	045242368549
											5	1	48475573	045242368921

Multi material : Heavy duty WRECKER™ carbide teeth demolition blades

The multi material WRECKER™ with carbide teeth cuts all from thick metal, cast iron, nail embedded wood, hardened screws and fastners.

Up to 50x longer life than standard Bi -metal blades. Carbide teeth deliver long life and extreme durability in the toughest applications.

Up to 25% more cuts per charge vs. standard Bi-Metal blades. Optimised for use with cordless tools.

FANG TIP™: For faster plunge cutting and reaching into restricted areas.

Thick 1.27mm robust blade body for precise straight cuts.

25 mm blade height for improved stability and minimum vibration.

Best for multi material demolition -cwood with nails or hardened fastners and thick metal



Blade length (mm)	Tooth pitch (mm)	Teeth per inch	Ref. No.								Pack quantity	Min. order quantity	Article Number	EAN Code
150	4.2	6	S956XHM	6 - 14	Ø 10 - 100	6 - 14	Ø 10 - 100	Yes	Yes	Yes	1	1	48475241	045242368433
											5	1	48475541	045242368815
230	4.2	6	S1156XHM	6 - 14	Ø 10 - 175	6 - 14	Ø 10 - 175	Yes	Yes	Yes	1	1	48475242	045242368440
											5	1	48475542	045242368822
300	4.2	6	S1256XHM	6 - 14	Ø 10 - 250	6 - 14	Ø 10 - 250	Yes	Yes	Yes	1	1	48475243	045242368457
											5	1	48475543	045242368839

Multi material: Heavy duty WRECKER™ blades



Strong and precise: Thick 1.27 mm blade body.

Bi-Metal construction: Excellent blade life and performance.

Tooth geometry: Aggressive strengthened tooth tip design and uniform gullet depth allows for more material to be removed per stroke for faster cutting.



Blade shape: Sloped - The sloped shape makes this blade ideal for plunge cutting. Most suited for cutting metal and for demolition applications (wood with nails).

Blade length (mm)	Tooth pitch (mm)	Teeth per inch	Ref. No.								Pack quantity	Min. order quantity	Article Number	EAN Code
150	3.6/2.3	7/11	-	4 - 10	Ø 10 - 100	4 - 10	Ø 10 - 100	Yes	Yes	Yes	5	1	48475701	045242368969
											5	1	48475706	045242369102
230	3.6/2.3	7/11	S3456XF	4 - 10	Ø 10 - 175	4 - 10	Ø 10 - 175	Yes	Yes	Yes	25	1	48008706	045242082520
											5	1	48475711	045242368983
300	3.6/2.3	7/11	-	4 - 10	Ø 10 - 250	4 - 10	Ø 10 - 250	Yes	Yes	Yes	25	1	48008711	045242082537
											5	1	48008711	045242082537

Multi material: wood / metal / plastic cutting blades

Blade length (mm)	Tooth pitch (mm)	Teeth per inch	Ref. No.								Pack quantity	Min. order quantity	Article Number	EAN Code
150	2.5	10	-	3 - 11	3 - 11	6 - 50	Yes	Ø 3 - 50	5	1	48475092	045242368181		
													5	1
200	2.5/1.8	10/14	S1122VF	3 - 11	3 - 11	5 - 175	Yes	Ø 3 - 160	50	1	48475193	045242368327		
													50	1
300	2.5/1.8	10/14	S1222VF	3 - 11	3 - 11	5 - 250	Yes	Ø 3 - 250	5	1	48475194	045242368334		
													5	1
150	3.2/2.1	8/12	-	3 - 11	3 - 11	5 - 100	Yes	Ø 3 - 100	50	1	48016091	045242084685		
													5	1
200	3.2/2.1	8/12	S725VFR	3 - 11	3 - 11	5 - 175	Yes	Ø 3 - 160	500	1	48016093	045242084708		
													500	1
300	3.2/2.1	8/12	-	3 - 11	3 - 11	5 - 250	Yes	Ø 3 - 250	5	1	48475094	045242368204		
													50	1

Wood and plastics blades

Blade length (mm)	Tooth pitch (mm)	Teeth per inch	Ref. No.					Pack quantity	Min. order quantity	Article Number	EAN Code	
	150	4.2	6	S644D	6 - 100	-	Ø 6 - 100	Yes	3	1	48001075	045242079810
	150	4.2	6	S744D	6 - 50	-	Ø 6 - 50	No	3	1	48001076	045242079827
	230	4.2	6	-	6 - 190	6 - 200	Ø 6 - 100	Yes	5	1	48475016	045242368068
	240	5.5/6	4/5	S1531L	15 - 190	15 - 200	-	No	3	1	48001077	045242079834
	240	8.5	3	S1542K	15 - 190	-	-	No	50	1	4932478111	4058546340445
	240	8.5	3	S1542K	15 - 190	-	-	No	3	1	48001078	045242079841
	150	4.2	6	-	6 - 60	6 - 60	-	No	2	1	4932493509	4058546483807
	275	4.2	6	-	6 - 200	6 - 200	-	No	2	1	4932471693	4058546295929
	300	4.2	6	S1344D	6 - 250	6 - 250	-	No	3	1	48001079	045242079858

SAWZALL™ blades for special materials

Special application: Ductwork blade

Plunge tip - fast plunging in materials < 0.6 mm. No need for extra tools.

Versatility - tapered blade body profile allows for tight radius cutting and square cuts.

Longlife - optimized tooth geometry 30 tpi for cutting thin material 0.6 - 1.5 mm. Most common spiral duct is 0.8 mm thick.



Blade length (mm)	Tooth pitch (mm)	Teeth per inch	Pack quantity	Min. order quantity	Article Number	EAN Code
85	0.8	30	5	1	48471630	045242368037

Special application: Drywall / plasterboard blade



Precise depth of cut - short blade length, protects from unintentional cuts in pipes or wiring.















Special tooth geometry produces less dust than a jobsaw handtool - cuts clean without ripping the drywall.

Plunge tip - fast and effortless plunging.



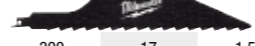

Blade length (mm)	Tooth pitch (mm)	Teeth per inch			Pack quantity	Min. order quantity	Article Number	EAN Code
63	-	-	Yes	Yes	1	1	48471640	045242368044

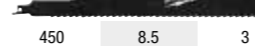
	125	4.2	6	Yes	Yes	5	1	48475052	045242368150
---	-----	-----	---	-----	-----	---	---	----------	--------------

Special application: Cast iron / abrasive materials / fibreglass

Blade length (mm)	Tooth pitch (mm)	Teeth per inch	Ref. No.						Pack quantity	Min. order quantity	Article Number	EAN Code	
	230	Diamond grit	-	Ø 10 - 160	Ø 10 - 160	3 - 175	-	-	1	1	48471450	045242368006	
	150	Carbide grit	-	Ø 10 - 100	Ø 10 - 100	3 - 100	-	-	3	1	48471420	045242367979	
	230	Carbide grit	S1130R	Ø 10 - 160	Ø 10 - 160	3 - 175	-	-	3	1	48471430	045242367986	
	305	8.5	3	S1241HM	-	-	6 - 150	10 - 250	10 - 250	1	1	48001080	045242079865
	235	17	1.5	S1543HM	-	-	6 - 135	10 - 135	10 - 135	1	1	4932498318	4058546521875
	300	17	1.5	S1243HM	-	-	6 - 150	10 - 200	10 - 200	1	1	4932498319	4058546521882
	450	17	1.5	S2243HM	-	-	6 - 150	10 - 350	10 - 350	1	1	48001460	045242235353
	235	8.5	3	S1141HM	-	-	6 - 135	10 - 135	10 - 135	1	1	4932498320	4058546521899
	300	8.5	3	S1241HM	-	-	4 - 150	10 - 200	10 - 200	1	1	4932498321	4058546521905
	450	8.5	3	S2041HM	-	-	4 - 150	10 - 350	10 - 350	1	1	4932498322	4058546521912

Special application: Insulation material / carton / foam

Blade length (mm)	Tooth pitch (mm)	Teeth per inch	Ref. No.					Pack quantity	Min. order quantity	Article Number	EAN Code	
	300	Wave knife	Wave knife	-	Yes	Yes	Yes	Yes	1	1	48001084	045242079902

Special application: Frozen materials

	230	6	4.2	-	-	-	-	100	1	4932501783	4058546644994
	300	6	4.2	S1211K	-	-	-	1	1	48001082	045242079889
	400	6	4.2	-	-	-	-	1	1	48001083	045242079896

Special Application: Flush cut blade



Flush cuts against floor - floor guard protects teeth from floor contact when cutting flush to the floor.
Extra tall blade body - guides blade for straighter cuts ie. when cutting out doors and windows in wood construction.

FANG TIP™ - for easy and quick plunging.

Suitable for cutting all types of wood and nail embedded wood. Not suitable for brick, masonry or steel.



Blade length (mm)	Tooth pitch (mm)	Teeth per inch	Ref. No.	Pack quantity	Min. order quantity	Article Number	EAN Code
300	5	5	-	1	1	48001600	045242253272

SAWZALL™ blade sets

Description	Pack quantity	Min. order quantity	Article Number	EAN Code
SAWZALL™ blade set (5pc)				
① 1 x AX™ wood with nails - 230 mm, 1 x WRECKER™ multi material - 230 mm, 1 x TORCH™ metal - 230 mm, 1 x TORCH™ metal - 150 mm, 1 x TORCH™ metal - 150 mm	5	1	49472205	045242481408
SAWZALL™ carbide demolition blades set (5pc)				
② Wood with nails: 2 x AX™ carbide - 230 mm / 5TPI. Metal: 2 x TORCH™ carbide - 150 mm / 8 TPI, 1 x TORCH™ carbide - 230 mm / 8 TPI	5	1	49472206	045242481446
SAWZALL™ blade set (10pc)				
③ 3 x THIN KERF metal - 150 mm, 3 x THIN KERF metal - 150 mm, 2 x THIN KERF wood with nails - 150 mm, 1 x THIN KERF wood with nails - 230 mm, 1 x THIN KERF metal - 230 mm	10	1	49472211	045242481958
SAWZALL™ blade set (12pc)				
④ 2 x AX™ wood with nails - 150 mm, 2 x AX™ wood with nails - 230 mm, 4 x TORCH™ metal - 150 mm, 2 x TORCH™ metal - 230 mm, 2 x WRECKER™ multi material - 150 mm	12	1	49472229	045242481934
SAWZALL™ blade set (13pc)				
⑤ 2 x WRECKER™ multi material - 150 mm, 2 x AX™ wood with nails - 150 mm, 2 x AX™ wood with nails - 230 mm, 4 x TORCH™ metal - 150 mm, 2 x TORCH™ metal - 230 mm, 1 x TORCH™ carbide - 150 mm	13	1	49472231	045242481460



HACKZALL™ blades

Especially engineered blades for exclusive use on 12 V HACKZALL™.

Bi-Metal construction for increased tooth durability.

Optimised tooth form for aggressive and faster cutting.

Thinner blade body for better speed of cut and up to 35% more cuts per charge vs. standard Bi Metal blades.

Blade length (mm)	Tooth pitch (mm)	Teeth per inch							Pack quantity	Min. order quantity	Article Number	EAN Code		
100	4.2	6	-	-	-	-	6 - 40	Ø 10 - 40	5	1	48475460	045242367788		
150	1.8	14	3 - 6	Ø 10 - 32	3 - 6	3 - 6	-	Ø 10 - 50	5	1	49005614	045242160334		
100	1.4	18	1.5 - 4	Ø 10 - 32	1.5 - 4	-	-	-	5	1	49005418	045242160341		
100	1	25	0.5 - 3	Ø 8 - 32	0.5 - 3	-	-	-	5	1	49005424	045242160358		
75	-	-	-	-	-	-	-	-	1	1	49005456	045242219476		
125	-	-	-	-	-	-	-	-	1	1	49005455	045242293421		
60	-	-	-	-	-	-	-	-	1	1	49005450	045242221066		
HACKZALL™ blade set (10 pc) 2 x 49005460, 3 x 49005614, 3 x 49005424, 2 x 49005418											10	1	49220220	045242160365

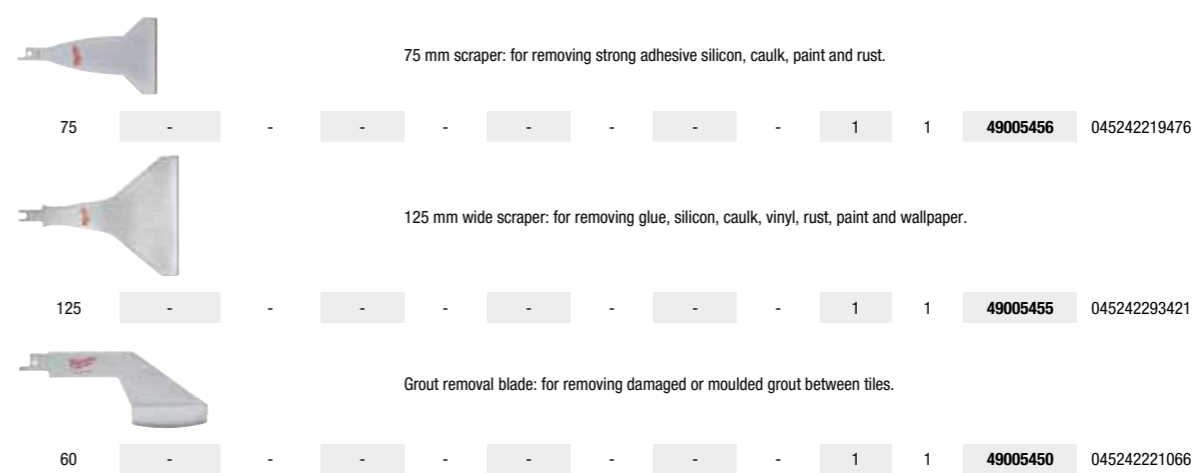



JIGSAW BLADES

MATERIAL QUALITIES

HCS

- High Carbon Steel jigsaw blades are used for cutting all types of wood and plastics.

HSS

- High Speed Steel blades are suited to cutting metal, non ferrous metal and aluminium.

CARBIDE GRIT

- These blades have a tungsten carbide grit edge making them suitable for abrasive materials.

TC

- Blades with tungsten carbide tipped teeth are ideally suited to glassfibre reinforced products. Those blades with a continuous tungsten carbide tooth strip cutting edge are suitable for extremely hard materials such as stainless steel.

BI-METAL

- Bi-Metal blades consist of high speed steel teeth electron beam welded onto a flexible alloy steel back. These blades offer maximum performance in the most demanding applications in both wood and metal.

BI-METAL BLADES OFFER THE FOLLOWING BENEFITS:

- Flexible and shatter resistant
- Longer lifetime. Metal cutting blades offer double the lifetime and wood cutting blades more than 5 times the lifetime over conventional HCS and HSS blades.
- High wear rate and heat resistance ensure the teeth stay sharp longer.
- Faster cutting performance.

Flexible and shatter resistant steel back for the most demanding of applications

Bi-Metal

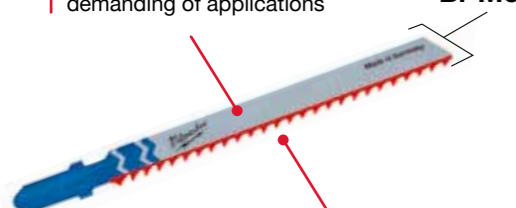

High speed steel teeth with extra hard cutting edge

Blade colour code

Shank colour means application



= For all types of wood, laminated chipboard, chipboard, plywood, blockboard and plastics. Silver colour blade body.



= For all types of ferrous and non-ferrous metals, steel, aluminium, brass, copper, stainless steel, lead, tin and sandwich materials. Silver colour blade body.



= For cutting a range of products, carton, rubber, fibreglass, foam and abrasive materials. Black colour blade body.



= Bi-Metal blades come with a white body and then the corresponding colour shank; yellow for wood and blue for metal.



Jigsaw blades for wood and plastic

Traditional blades

Traditional blades that deliver good and solid performance.

Blade length (mm)	Tooth pitch (mm)	Ref. No.	Image	Image	Image	Image	Image	Image	Image	Image	Pack quantity	Min. order quantity	Article Number	EAN Code
50	2	T 119 B	< 20	-	< 20	Yes	-	No	No	No	5	1	4932274353	4002395301553
75	3	T 111 C	5 - 50	-	< 40	-	Yes	No	No	No	5	1	4932254071	4002395301539

Curve cutting blades

All of our curve cutting blades are characterised by a narrow blade body for improved manoeuvrability.

Jigsaw blade 4932265312 and 4932430143 has cutting teeth on both sides.

The teeth on the back of the blade allows one to cut tight and acute curves with simplicity.

For best results work without pendulum action when cutting tight curves.

50	1.35	T 101 A0	< 20	< 20	< 15	Yes	No	Yes	No	No	5	1	4932373392	4002395348879
50	2	T 119 B0	< 20	-	< 20	Yes	No	Yes	No	No	5	1	4932274650	4002395301485
75	2.5	Curve	< 30	< 20	< 20	Yes	No	Yes	No	Yes	5	1	4932430143	4002395378043
75	4 / 1.2	Special	< 30	-	< 30	No	Yes	Yes	No	No	5	1	4932265312	4002395301478
75	4	T 244 D	< 50	-	-	No	Yes	Yes	No	Yes	5	1	4932346078	4002395312375
											25	1	4932373492	4002395349920

Fast cut blades

The sharp and aggressive tooth geometry is ideal for very fast cutting of wood.

75	4	T 144 D	< 50	-	-	No	Yes	No	No	Yes	5	1	4932213116	4002395301492
											25	1	4932373487	4002395349272
											100	1	4932430461	4002395381227
75	4	T 144 DF	< 50	-	-	No	Yes	No	No	Yes	5	1	4932373391	4002395348862
105	4	T 344 D	< 80	-	-	No	Yes	No	No	Yes	5	1	4932311633	4002395301508
155	4	T 744 D	5-125	-	-	No	Yes	No	No	Yes	5	1	4932354745	4002395324095

Fast and clean cutting blades

Triple sharpened tooth geometry for fast and super clean splinter free cuts. Plunge tip for fast plunging.

Blade length (mm)	Tooth pitch (mm)	Ref. No.										Pack quantity	Min. order quantity	Article Number	EAN Code
91	2.5	T 234 X	3 - 60	3 - 60	Yes	< 45	No	No	Yes	No		5	1	4932430141	4002395378029

Clean and splinter free cutting blades

The following blades have diagonally sharpened side teeth resulting in a very clear splinter free cut.

	75	2.5	T 101 B	< 30	< 60	No	< 30	Yes	No	No	No	5	1	4932254061	4002395301522
	75	2.5	T 101 BF	< 30	< 60	No	< 30	Yes	No	No	No	5	1	4932373390	4002395348855
	75	4	T 101 D	< 50	< 60	No	< 45	Yes	No	No	No	5	1	4932274351	4002395301515
	105	3	T 301 CD	< 80	< 60	No	-	Yes	No	No	No	5	1	4932399306	4002395359202
	105	4	T 301 DL	< 80	< 80	No	< 50	Yes	No	No	No	5	1	4932346071	4002395312399

Precise straight cutting blades: Kitchen worktops

The following blades benefit from a thicker blade body guaranteeing extra stiffness and consequently a more accurate vertical cut. Ideal for those applications where a true square cut is necessary - i.e. kitchen worktops.

	75	4	T 101 DP	< 60	< 60	No	< 45	Yes	No	No	Yes	5	1	4932373080	4002395346073
	105	4	T 101 DP sp.	< 80	< 80	No	< 50	Yes	No	No	Yes	5	1	4932373388	4002395348831

Special application: Kitchen worktops / laminated chipboard

These blades have a reversed tooth design, this means that the blade cuts on the downward stroke making them extremely suitable for clean and splinter free cuts in laminated chipboard and especially kitchen worktops in situ.

For best results work without pendulum action.

	75	2.5	T 101 BR	< 30	< 60	No	< 60	Yes	No	No	No	5	1	4932346079	4002395312382
	105	2.5	T101BR sp.	< 50	< 80	No	< 80	Yes	No	No	No	5	1	4932348072	4002395313860

Special application: Laminated flooring / parquet flooring

Blade 4932373392 is ideally suited for cutting curves and irregular shapes. Use blade 4932373083 for straight cuts.

	50	1.35	T 101 A0	< 20	No	< 20	< 15	Yes	No	Yes	No	5	1	4932373392	4002395348879
	60	1.9	Special	3 - 20	Yes	Yes	-	Yes	No	No	No	5	1	4932373083	4002395346080

Jigsaw blades for metal

Traditional blades

Blade reference 4932274652 is especially suited to cutting very thin sheet material because of its low 0.7 mm tooth pitch.

For those professionals desiring extra lifetime and durability we recommend the use of Bi-Metal blades in conjunction with a suitable cooling lubricant, the blades lifetime is double that of non Bi-Metal blades.

Blade length (mm)	Tooth pitch (mm)	Ref. No.											Pack quantity	Min. order quantity	Article Number	EAN Code
55	0.7	T 118 G	0.5 - 2	0.5 - 2	-	-	-	-	-	-	-	No	5	1	4932274652	4002395301621
55	1.2	T 118 A	1.5 - 4	1.5 - 4	-	-	-	-	-	-	-	No	5	1	4932254063	4002395301614
55	1.2	T 118 AF	1.5 - 4	1.5 - 4	-	-	-	-	-	-	-	No	25	1	4932373486	4002395349265
55	1.2	T 118 AF	1.5 - 4	1.5 - 4	-	1.2 - 2	-	-	-	-	-	No	5	1	4932340011	4002395304684
66	1.2	T 118 A sp.	1.5 - 4	1.5 - 4	-	-	-	-	-	-	-	No	5	1	4932345826	4002395313464
105	1	T 318 A	1 - 4	1 - 4	< 85	-	-	-	-	-	-	No	5	1	4932399307	4002395359219
55	2	T 118 B	3 - 6	3 - 6	-	-	3 - 10	-	-	-	-	No	5	1	4932254064	4002395301591
55	2	T 118 BF	3 - 6	3 - 6	-	2 - 3	3 - 10	-	2 - 30	-	-	No	5	1	4932340012	4002395304691
75	2.5	T 101 A sp.	-	2 - 10	< 45	-	3 - 10	-	2 - 20	-	-	No	5	1	4932274651	4002395301577

Universal application blades

These blades are suitable for cutting a wide variety of materials ranging from steel, aluminium, wood with nails, plastics and sandwich composites. Blade 4932373086 with its extra length (155 mm) is suitable for cutting thick corrugated sandwich material.

91	2.5 / 1.8	T 123 XF	2.5 - 10	3 - 10	< 50	-	4 - 10	-	-	-	-	No	5	1	4932430142	4002395378036
105	1.2	T 318 AF	1.5 - 4	1.5 - 4	< 85	-	-	-	-	-	-	No	5	1	4932274654	4002395301607
105	2	T 318 BF	3 - 6	3 - 6	< 85	-	3 - 10	4 - 30	-	-	-	No	5	1	4932274653	4002395301584
155	1	T 718 AF	1 - 4	1 - 4	< 125	-	-	-	-	-	-	No	5	1	4932373086	4002395346097

Curve cutting blades

Especially narrower saw blade body allows one to cut tight curves in a range of metallic materials.

55	1.2	T 218 A	1.5 - 4	1.5 - 4	-	-	-	-	-	-	-	Yes	5	1	4932346082	4002395312368
75	3	T 227 D	3.5 - 6	3.5 - 6	-	-	4 - 15	4 - 30	-	-	-	Yes	5	1	4932346081	4002395312351

Special application: Aluminium

Most traditional blades are also capable of cutting aluminium, however these two blades benefit from a larger tooth pitch and wider gullets offering better material removal which is an advantage when cutting aluminium.

When cutting curves or irregular shapes in aluminium we recommend the use of blade 4932346081.

Blade length (mm)	Tooth pitch (mm)	Ref. No.							Pack quantity	Min. order quantity	Article Number	EAN Code
75	3	T 127 D	3.5 - 6	3.5 - 6	-	-	4 - 15	4 - 30	5	1	4932274315	4002395301560

Special application: Stainless steel

This blades teeth consist of a carbide tipped strip making it the most suitable and durable blade for steels with a high alloy content such as stainless steel.









For best results work without pendulum action and use cutting oil as a lubricant.

Blade length (mm)	Tooth pitch (mm)	Ref. No.							Pack quantity	Min. order quantity	Article Number	EAN Code
50	1.1	T 118 AHM	1.5 - 3	1.5 - 3	-	1.5 - 3	-	-	2	1	4932373393	4002395348886









Jigsaw blades for special materials

Special applications: Fibreglass / reinforced plastics / acrylic glass

Blade 4932373387 and 4932493687 have tungsten carbide teeth for longer lifetime in hard materials such as GRP/GFK – glass reinforced plastics / fibreglass and WPC - wood plastic composite.

Blade length (mm)	Tooth pitch (mm)	Ref. No.									Pack quantity	Min. order quantity	Article Number	EAN Code	
75	2.5	T 101 A sp.	2 - 10	-	No	No	-	2 - 20	-	-	No	5	1	4932274651	4002395301577
75	4.2	T 141 HM	-	-	No	No	5 - 20	-	5 - 20	-	Yes	1	1	4932399308	4002395359226
91	3.3	T301CHM	-	< 60	No	No	5 - 20	2 - 20	5 - 20	-	Yes	2	1	4932493687	4058546508470
105	4.2	T 341 HM	-	< 60	No	No	5 - 20	-	5 - 20	-	No	1	1	4932373387	4002395348824

Special application: Abrasive materials / cast iron

Blade length (mm)	Grain	Ref. No.									Pack quantity	Min. order quantity	Article Number	EAN Code		
54	Grain 30	T 130 Coarse grit	-	-	Yes	Yes	< 15	-	-	Yes	5 - 15	No	1	1	4932213231	4002395301645
54	Grain 50	T 150 Fine	-	-	Yes	Yes	< 10	-	-	Yes	5 - 15	No	1	1	4932213232	4002395301652

Special application: Insulation material







Blade length (mm)	Tooth pitch (mm)	Ref. No.					Pack quantity	Min. order quantity	Article Number	EAN Code
155	Wave knife	T 313 AW	Yes	Yes	Yes	Yes	5	1	4932430144	4002395378050

Jigsaw blade sets - T-Shank reception

Description	Pack quantity	Min. order quantity	Article Number	EAN Code
① Jigsaw blades set (5pc) - suitable for applications in wood and metal Jigsaw blade 4932213116, 4932254061, 4932254063, 4932254064, 4932254071	5	1	4932345825	4002395314850
② Jigsaw blades set (35pc) - suitable for applications in wood and metal Contents: 7 x 4932213116 - T144D wood fast cut, 7 x 4932274351 - T101D wood clean cut, 7 x 4932254061 - T101B wood extra clean cut, 7 x 4932346078 - T244D wood fast curve cut, 7 x 4932254063 - T118A metal	35	12	4932479088	4058546368821



U-Shank jigsaw blades

Blade length (mm)	Tooth pitch (mm)	Ref. No.							Pack quantity	Min. order quantity	Article Number	EAN Code
75	4	A 2202	5 - 60	< 60	-	No	Yes	Yes	5	1	4932354508	4002395321070
75	2.5	A5035/A5041	< 30	< 60	< 30	Yes	No	No	5	1	4932354506	4002395321056

OSCILLATING MULTI-TOOL BLADES

STARLOCK

NO COMPONENTS OR ADAPTORS REQUIRED

FAST BLADE CHANGES

100% POWER TRANSMISSION FROM TOOL TO ACCESSORY

ONE UNIVERSAL SYSTEM

WHY MILWAUKEE®?

- ① BEST LIFETIME & DURABILITY
- ② ALL-TRADE FOCUSED SOLUTIONS
- ③ FULLY-STACKED COMPREHENSIVE RANGE
- ④ OVER 22 OMT PRODUCTS IN THE RANGE



CARBIDE EXTREME

Multi Material 35mm plunge cut carbide toothed blade for extra long-life (30X more life than standard blades).

48906040

30x MORE CUTS

CARBIDE EXTREME

Description	Soft Wood	Hard Wood	Plastic	Wood+Nails	Metal	Grout	Tile Adhesive	Pack quantity	ART.#
Wood 35mm plunge cut blade.	✓		✓					1	48906001
Wood 35mm plunge cut blade with 3 cut tooth geometry for fast and clean cuts.	✓	✓	✓					1	48906011
Wood 65mm wide plunge cut blade.	✓		✓					1	48906005
Wood 65mm wide plunge cut blade with 3 cut tooth geometry for fast and clean cuts.	✓	✓	✓					1	48906015
Wood 35mm plunge cut Bi-Metal blade for long-life and 3 cut tooth geometry for fast and clean cuts.	✓	✓	✓					1	48906017
Wood with nails 20mm narrow plunge cut Bi-Metal blade for long-life.	✓		✓	✓				1	48906000
Wood with nails 35mm plunge cut Bi-Metal blade for long-life.	✓		✓	✓				1	48906021
Wood with nails 65mm plunge cut Bi-Metal blade for long-life.	✓		✓	✓				1	48906027
Multi Material 28mm plunge cut Bi-Metal blade for long-life.	✓	✓	✓	✓	✓			1	48906031
Multi Material 43mm plunge cut Bi-Metal blade for long-life.	✓	✓	✓	✓	✓			1	48906035
Multi Material 95mm plunge cut carbide toothed blade for extra long-life (30X more life than standard blades).	✓	✓	✓	✓	✓			1	48906040
Multi Material 85mm diameter segmented flush cut blade.	✓	✓	✓	✓	✓			1	48906038
Multi Material 100mm diameter segmented flush cut Bi-Metal blade for long-life.	✓	✓	✓	✓	✓			1	48906039
Grout removal 2.2mm thick carbide grit blade. For removing damaged grout between wall or floor tiles.						✓		1	48906051
Grout removal 1.2mm thick carbide grit blade. For removing damaged grout between wall or floor tiles.						✓		1	48906050
Grout removal 2.2mm thick diamond grit blade for extra long life. For removing damaged grout between wall or floor tiles. 5x more life than carbide grout blades.						✓		1	48906053
Grout removal 1.2mm thick diamond grit blade for extra long life. For removing damaged grout between wall or floor tiles. 5x more life than carbide grout blades.						✓		1	48906052
Rasp with carbide grit for rough sanding and smoothing of tile adhesive, mortar and wood.	✓						✓	1	48906054
Firm scraper for removal of hard residues like hard adhesives, tile adhesives, concrete residues and old paint.							✓	1	48906062

SANDING

Sanding pad with 6 holes, hook and loop fixation.

48906070



Description

Perforated sanding discs for wood, paint, lacquer and plaster 93x93x93mm.

Powergrid Mesh - 80-240 grit
High performance - 40-240 grit
Standard - 40-240 grit

Multi-Tool accessories - STARLOCK reception

STARLOCK universal blade reception makes Milwaukee® blades compatible with the most popular oscillating tools.

Wood cutting blades

Description	Width (mm)	Length (mm)	Soft wood	Hard Wood	Plastics	Wood with nails	Metal channel and profiles	Pack quantity	Min. order quantity	Article Number	EAN Code
① Wood 35 mm plunge cut blade	35	42	✓		✓			1	1	48906001	045242600298
								10	1	48906004	045242600281
② Wood 35 mm plunge cut blade with 3 cut tooth geometry for fast and clean cuts	35	42	✓	✓	✓			1	1	48906011	045242600304
								10	1	48906014	045242600311
③ Wood 65 mm wide plunge cut blade	65	42	✓		✓			1	1	48906005	045242600274
								50	1	48906505	045242739943
④ Wood 65 mm wide plunge cut blade with #3 cut tooth geometry for fast and clean cuts	65	42	✓	✓	✓			1	1	48906015	045242600328
⑤ Wood 35 mm plunge cut Bi-Metal blade for long life and 3 cut tooth geometry for fast and clean cuts	35	42	✓	✓	✓			1	1	48906017	045242600335
								10	1	48906019	045242600342



Multi material cutting blades

Description	Width (mm)	Length (mm)	Soft wood	Hard Wood	Plastics	Wood with nails	Metal channel and profiles	Pack quantity	Min. order quantity	Article Number	EAN Code	
① Wood with nails 20mm narrow plunge cut Bi-Metal blade for long life	20	34	✓	✓	✓	✓		1	1	48906000	045242670673	
② Wood with nails 35 mm plunge cut Bi-Metal blade for long life	35	42	✓	✓	✓	✓		1	1	48906021	045242600359	
								10	1	48906024	045242600366	
								50	1	48906521	045242739929	
③ Wood with nails 65 mm plunge cut Bi-Metal blade for long life	65	42	✓		✓	✓		1	1	48906027	045242600373	
								50	1	48906527	045242739950	
④ Multi Material 28 mm plunge cut Bi-Metal blade for long life	28	47	✓	✓	✓	✓	✓		1	1	48906031	045242600380
									10	1	48906034	045242600397
									50	1	48906531	045242739936
⑤ Multi Material 43 mm plunge cut Bi-Metal blade for long life	43	47	✓	✓	✓	✓	✓	1	1	48906035	045242600403	
⑥ Multi Material 35 mm plunge cut carbide toothed blade for extra long life (30x life than standard blades)	35	32	✓	✓	✓	✓	✓	1	1	48906040	045242600458	
⑦ Multi Material 85 mm diameter segmented flush cut blade	85	20	✓	✓	✓	✓	✓	1	1	48906038	045242600410	
⑧ Multi Material 100 mm diameter segmented flush cut Bi-Metal blade for long life	100	28	✓	✓	✓	✓	✓	1	1	48906039	045242600427	



Grout removal and rasping blades

Description	Width (mm)	Length (mm)	Grout	Tile adhesive	Pack quantity	Min. order quantity	Article Number	EAN Code
① Grout removal 2.2 mm carbide grit blade. For removing damaged grout between wall or floor tiles	75	20	✓		1	1	48906051	045242600441
② Grout removal 1.2 mm carbide grit blade. For removing damaged grout between wall or floor tiles	75	20	✓		1	1	48906050	045242600434
③ Grout removal 2.2 mm diamond grit blade for extra long life. For removing damaged grout between wall or floor tiles	90	25	✓		1	1	48906053	045242600489
④ Grout removal 1.2 mm diamond grit blade for extra long life. For removing damaged grout between wall or floor tiles	75	25	✓		1	1	48906052	045242600465
⑤ Rasp with carbide grit for rough sanding and smoothing of tile adhesive, mortar and wood	80	80		✓	1	1	48906054	045242600496

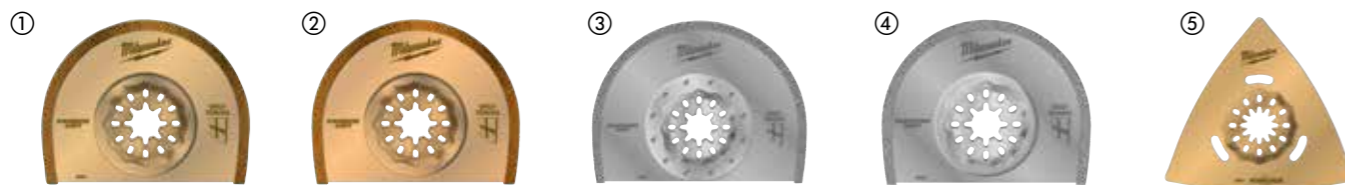

Scraping and cutting blades

Description	Width (mm)	Length (mm)	Tile adhesive	Adhesives	Carpet	Silicon / Acrylic	Pack quantity	Min. order quantity	Article Number	EAN Code
① Flexible scraper for removal of soft residues like silicone, acrylic, carpet adhesive and old paint	52	37		✓		✓	1	1	48906061	045242600540
② Firm scraper for removal of hard residues like hard adhesives, tile adhesives, concrete residues and old paint	52	37	✓	✓	✓		1	1	48906062	045242600557
③ Flexible cutter/scraper for silicone and soft window putty material	70	-				✓	1	1	48906063	045242600564
④ Knife with 3 cutting edges. For cutting carpet, PVC flooring, cardboard and roofing felt	40	-			✓		1	1	48906060	045242600519



Sanding / polishing / cleaning

Description	Width (mm)	Length (mm)	Pack quantity	Min. order quantity	Article Number	EAN Code
① Sanding pad 93 x 93 mm - Hook & Loop	93	93	1	1	48906070	045242600571

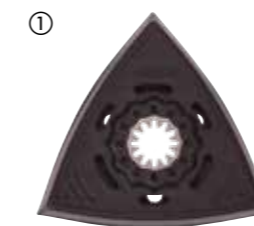

Multi-tool sets

Description	Pack quantity	Min. order quantity	Article Number	EAN Code
Wood blade set (5pc)				
① 2 x 48906001 35mm wood plunge cut blade, 2 x 48906011 35mm soft and hard wood plunge cut blade with 3 cut tooth geometry, 1 x 48906021 35mm wood and nails Bi-Metal plunge cut blade	5	12	48906114	045242670680
Wood and metal blade set (5pc)				
② 1 x 48906011 35mm soft and hardwood plunge cut blade with 3 cut tooth geometry, 2 x 48906021 35mm wood and nails Bi-Metal plunge cut blade, 2 x 48906031 28mm multi material plunge cut blade	5	12	48906115	045242670697
Renovation set (8pc)				
③ 2 x multi mat. 28mm plunge cut blade, 2 x multi mat. 43mm plunge cut blade, 1 x grout removal 2.2mm carbide blade, 1 x 3X cutting knife, 1 x rasp carbide grit, 1 x flexible scraper 52mm	8	1	48906088	045242600649
General multi-tool blade set (11pc)				
④ 2 x 35 mm plunge cut blade, 2 x 65 mm plunge cut blade, 1 x 65 mm 3C fast plunge cut blade, 2 x multi mat. 28 mm plunge cut blade, 2 x multi mat. 43 mm plunge cut blade, 1 x multi mat. 85 mm seg. flush cut blade, 1 x firm scraper 52 mm	11	1	48906090	045242600663
⑤ Multi-tool box	1	1	4932479838	4058546376321



Router bit sets

Description	Pack quantity	Min. order quantity	Article Number	EAN Code
① Router bit set with 8mm shank (12pc)	12	1	4932451668	4002395275564
② Router bit set with 12mm shank (6pc)	6	1	4932493578	4058546484491
③ Router bit set with 1/2" inch shank (6pc)	6	1	4932493579	4058546484507

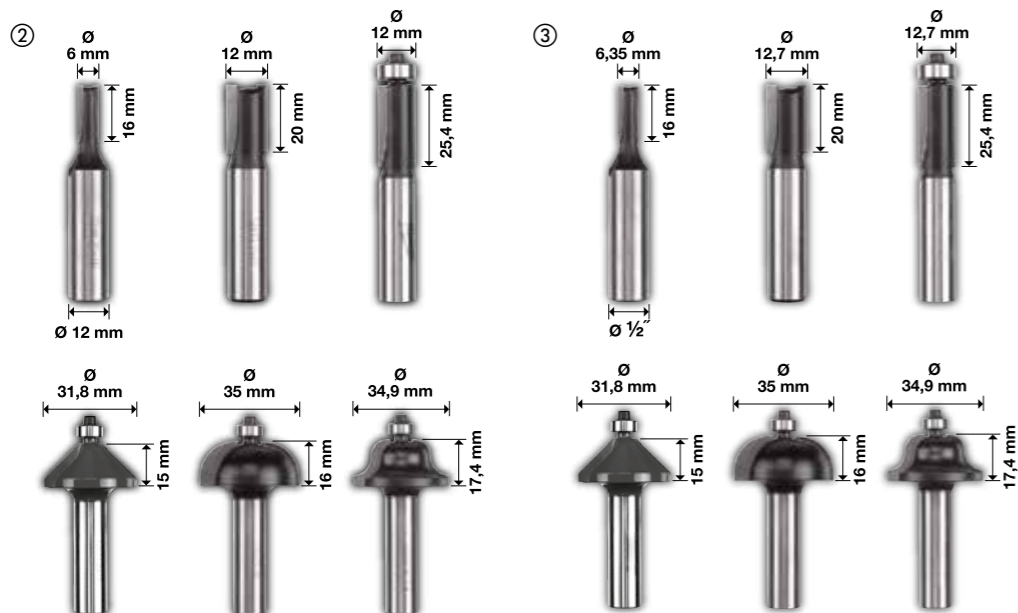

DESIGNED FOR USE IN
PACKOUT



MILWAUKEE® ROUTER BITS

BEST FINISH // DURABILITY // PRECISION

MILWAUKEE® Router Bits are designed for unmatched precision and long-lasting performance. Whether you're shaping edges, cutting grooves, or crafting custom joinery, our router bits deliver clean, consistent results on every pass. Engineered for durability, they're ready for any jobsite or workshop. Explore our full range of Router Bits — perfect for professionals who demand accuracy, control, and cutting-edge reliability.

FEATURES

ULTRA SHARP
MULTI AXIS GRINDING PROCESS
PRODUCES AN ULTRA SHARP CUTTING
EDGE GEOMETRY. BEST EDGE RETENTION
- STAYS SHARPER LONGER

**COBALT INFUSED
CARBIDE**
COBALT MICRO GRAIN TUNGSTEN
CARBIDE FOR BEST DURABILITY AND
LIFETIME. THICK CARBIDE FOR MULTIPLE
RESHARPENINGS

**TRIPLE LAYER
BRAZING PROCESS**
CARBIDE IS BRAZED ONTO THE BODY
USING A TRIPLE LAYER PROCESS
(SILVER-COPPER-SILVER) TO GIVE
THE STRONGEST BOND

SUPERIOR STEEL
PRODUCED FROM BEST QUALITY SOLID
STEEL BAR STOCK FOR EXTRA STRENGTH
AND PERFECT CONCENTRICITY OF THE
SHANK

ANTI-FRICTION COATING
REDUCES BINDING, FRICTION AND HEAT BUILD UP.
CUTS COOL. PROTECTS AGAINST CORROSION AND
ACCUMULATION OF RESIN

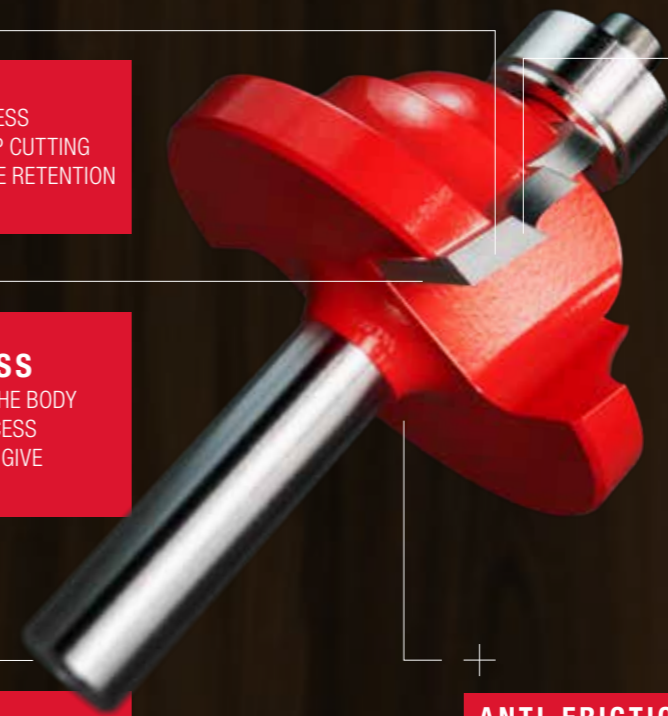

Straight bits

2 carbide edges ensure clean, smooth and precise grooves or slots in soft/hard woods, MDF, plastic coated boards, plywood, plastics and composites. Bits from 3-8mm diameter are solid carbide for better durability and lifetime.

With bottom cutting edge making them ideal for plunge cuts.

On small diameters as well as long router bits make multiple shallow passes to prevent damaging the bit.

Ref. 4932501169 is supplied with an extra carbide cutting edge at the tip for better performance and lifetime.

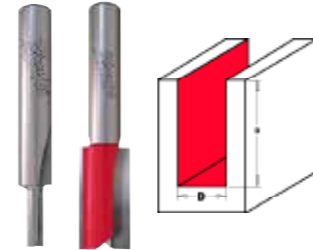

Shank diameter (mm)	Diameter (mm)	Total length (mm)	Working length (mm)	Solid carbide HW	Pack quantity	Min. order quantity	Article Number	EAN Code
1/4"	3.2	45	9.5	Yes	1	1	4932500852	4058546621544
1/4"	4	45	10	Yes	1	1	4932500853	4058546621551
1/4"	4.75	50.8	12.7	Yes	1	1	4932500854	4058546621568
1/4"	5	50	12	Yes	1	1	4932500855	4058546621575
1/4"	6	50	16	Yes	1	1	4932500856	4058546621582
1/4"	6	60	25.4	Yes	1	1	4932501163	4058546624651
1/4"	6.35	50.8	19	Yes	1	1	4932500857	4058546621599
1/4"	6.35	60	25.4	Yes	1	1	4932500858	4058546621605
1/4"	8	50	20	Yes	1	1	4932500859	4058546621612
1/4"	9.5	63.5	31.7	1	1	1	4932500861	4058546621636
1/4"	9.5	63.5	25.4	1	1	1	4932500860	4058546621629
1/4"	10	48	20	1	1	1	4932500862	4058546621643
1/4"	12	50	20	1	1	1	4932500863	4058546621650
1/4"	12	60	31.7	1	1	1	4932501164	4058546624668
1/4"	12.7	57.2	19	1	1	1	4932500864	4058546621667
1/4"	12.7	70	31.7	1	1	1	4932500865	4058546621674
1/4"	15	57.2	20	1	1	1	4932501165	4058546624675
1/4"	19	57.2	20	1	1	1	4932500866	4058546621681
1/2"	6.35	63.5	19	Yes	1	1	4932500867	4058546621698
1/2"	9.5	73	31.7	1	1	1	4932500868	4058546621704
1/2"	10	60	31.7	1	1	1	4932501166	4058546624682
1/2"	12	70	31.7	1	1	1	4932501167	4058546624699
1/2"	12.3	63.5	25.4	1	1	1	4932500869	4058546621711
1/2"	12.7	76.2	31.7	1	1	1	4932500870	4058546621728
1/2"	12.7	108	50.8	1	1	1	4932500871	4058546621735
1/2"	12.7	111	63.5	1	1	1	4932500872	4058546621742
1/2"	16	70	31.7	1	1	1	4932501168	4058546638849
1/2"	19	63.5	25.4	1	1	1	4932500873	4058546621759
1/2"	19	82.5	38.1	1	1	1	4932500874	4058546621766
1/2"	25.4	76.2	31.7	1	1	1	4932500875	4058546621773
1/2"	12.7	108	50.8	4	1	1	4932501050	4058546623524
8	3	50	8	Yes	1	1	4932500876	4058546621780
8	4	50	10	Yes	1	1	4932500877	4058546621797
8	5	50	12	Yes	1	1	4932500878	4058546621803
8	6	50	16	Yes	1	1	4932500879	4058546621810
8	6	60	25.4	Yes	1	1	4932500880	4058546621827
8	7	49	18	Yes	1	1	4932500881	4058546621834
8	8	50	20	Yes	1	1	4932500882	4058546621841
8	8	60	31.7	Yes	1	1	4932500883	4058546621858
8	10	48	20	1	1	1	4932500884	4058546621865
8	10	60	31.7	1	1	1	4932500885	4058546621872
8	12	50	20	1	1	1	4932500886	4058546621889
8	12	60	31.7	1	1	1	4932500887	4058546621896
8	12.7	70	31.7	1	1	1	4932501170	4058546638863
8	14	50	20	1	1	1	4932500888	4058546621902
8	14	60	31.7	1	1	1	4932500889	4058546621919
8	15	57.2	20	1	1	1	4932500890	4058546621926
8	15	66	31.7	1	1	1	4932500891	4058546621933
8	16	57.2	20	1	1	1	4932500892	4058546621940
8	16	66	31.7	1	1	1	4932500893	4058546621957
8	18	50	20	1	1	1	4932500894	4058546621964
8	20	50	20	1	1	1	4932500895	4058546621971
8	22	57.2	20	1	1	1	4932500896	4058546621988
8	24	50	20	1	1	1	4932500897	4058546621995
8	25	50	20	1	1	1	4932500898	4058546622008
12	4	58	10	1	1	1	4932500899	4058546622015
12	6	60	25.4	Yes	1	1	4932500900	4058546622022
12	8	75	31.7	Yes	1	1	4932500901	4058546622039
12	10	74	31.7	1	1	1	4932500902	4058546622046
12	12	95	38.1	1	1	1	4932500903	4058546622053
12	12	108	50.8	1	1	1	4932500904	4058546622060
12	12	110	70	1	1	1	4932501169	4058546638856
12	15	70	31.7	1	1	1	4932501171	4058546638870
12	16	70	31.7	1	1	1	4932500905	4058546622077
12	18	80	38.1	1	1	1	4932501172	4058546638887
12	20	80	38.1	1	1	1	4932500906	4058546622084
12	22	80	38.1	1	1	1	4932500907	4058546622091

Upcut spiral solid carbide bits

Upcut spiral bits have a sharpened tip so they plunge faster and as deep as you like without stopping; in comparison standard straight bits only plunge in intervals of 25mm maximum.

An upcut spiral bit removes the chips upwards for optimum chip clearance resulting in faster feed rates without burning and a clean finish on the bottom of the material.

Suitable for soft/hard woods, MDF, plastic coated boards, plywood, plastics and composites.

For use on portable/benchtop routers as well as CNC machines.

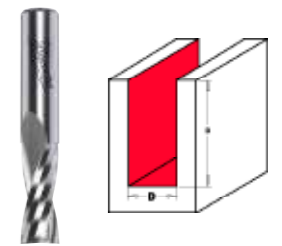

Shank diameter (mm)	Diameter (mm)	Total length (mm)	Working length (mm)	Solid carbide HW	Pack quantity	Min. order quantity	Article Number	EAN Code
1/4"	3.18	50.8	12.7	Yes	1	1	4932500908	4058546622107
1/4"	3.97	50.8	12.7	Yes	1	1	4932500909	4058546622114
1/4"	4.76	50.8	19.05	Yes	1	1	4932500910	4058546622121
1/4"	6.35	63.5	25.4	Yes	1	1	4932500911	4058546622138
1/2"	12.7	76.2	31.75	Yes	1	1	4932500912	4058546622145
8	3	60	12	Yes	1	1	4932500913	4058546622152
8	4	60	15	Yes	1	1	4932500914	4058546622169
8	5	60	17	Yes	1	1	4932500915	4058546622176
8	6	70	27	Yes	1	1	4932500916	4058546622183
8	8	80	32	Yes	1	1	4932500917	4058546622190
12	12	100	52	Yes	1	1	4932500918	4058546622206

Morticing hinge bits

2 extra thick carbide tips for producing tenons, mortices and for recessing hinges.

The carbide tips have a negative shear angle ensuring a splinter free finish.

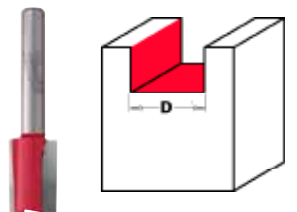

Shank diameter (mm)	Diameter (mm)	Total length (mm)	Working length (mm)	Pack quantity	Min. order quantity	Article Number	EAN Code
1/4"	12.7	54	20	1	1	4932500921	4058546622237
8	19	54	19	1	1	4932500922	4058546622244

Flush trimming bits

Carbide 2 flute bit with bottom bearing for self-guiding
The bearing has the same diameter as the cutter making it ideal for trimming one surface flush with an adjoining surface for plastic or wood overlays.
Trimming bits with a shear cutting angled flute require less feed pressure so cut quicker. The angled flute means there is less force on the cutting edge for less breakages plus they reduce the risk of tear-out for even cleaner cuts in wood and melamine boards.
After resharpening replace the bearing as follows. Bearing B8 Ø 9,5mm 4932501062 with bearing B9 Ø 9,3mm 4932501063. Bearing B10 Ø 12,7mm 4932501064 with bearing B12 Ø 12,5mm 4932501066.

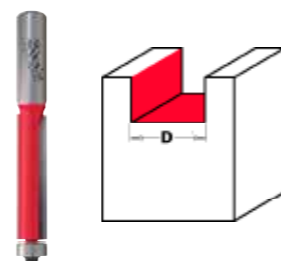

Shank diameter (mm)	Diameter (mm)	Total length (mm)	Working length (mm)	Solid carbide HW	Cutting Angle (°)	Pack quantity	Min. order quantity	Article Number	EAN Code
¼"	6.35	63.5	25.4	Yes	0°	1	1	4932500923	4058546622251
¼"	9.5	55.5	12.7		0°	1	1	4932501173	4058546638894
¼"	9.5	68.2	25.4		0°	1	1	4932500924	4058546622268
¼"	12.7	70.7	25.4		-3°	1	1	4932500925	4058546622275
¼"	12.7	71	25.4		0°	1	1	4932501174	4058546638900
½"	12.7	94	38.1		0°	1	1	4932500926	4058546622282
½"	12.7	104	50.8		0°	1	1	4932500927	4058546622299
½"	19	110	50.8		-3°	1	1	4932500928	4058546622305
8	9.5	68.2	25.4		0°	1	1	4932500929	4058546622312
8	12.7	70.7	25.4		-3°	1	1	4932500930	4058546622329
8	19	74.5	25.4		-3°	1	1	4932500931	4058546622336
12	12.7	104	50.8		0°	1	1	4932500932	4058546622343
12	19	110	50.8		-3°	1	1	4932500933	4058546622350

Flush trimming bits with carbide insert knives

Straight flush router bit with two replaceable carbide insert knives with bottom bearing.
Knives have 4 x 35° cutting edges so can be rotated to give double the life.
Ø8mm shaft with one bearing and larger Ø12 / 1/2" shaft with double bottom bearing

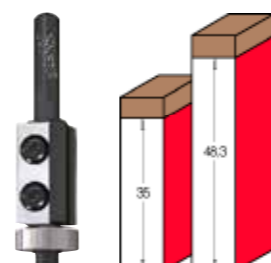

Shank diameter (mm)	Diameter (mm)	Total length (mm)	Working length (mm)	Bearing type	Collar type	Knives type	Screws / Nuts type	Washers / Spacers type	Pack quantity	Min. order quantity	Article Number	EAN Code
½"	19	112	50	B6	C4	K4	S2, S3	W4	1	1	4932500934	4058546622367
8	19	77	30	B6	C2	K3	S2, S3	W4	1	1	4932500935	4058546622374
12	19	112	50	B6	C4	K4	S2, S3	W4	1	1	4932500936	4058546622381

Template profile bits

Carbide 2 flute bit with top bearing for precise self-guiding along a template without the need of a guide bush, forming an exact duplicate of the template.
Also perfect for cutting repeatable and complex shapes.
The bearing has the same diameter as the cutter.
Bits have a bottom cutting edge so can be plunged prior to following a template.

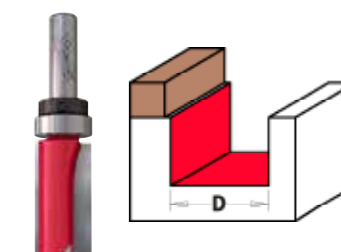

Shank diameter (mm)	Diameter (mm)	Total length (mm)	Working length (mm)	Bearing type	Collar type	Pack quantity	Min. order quantity	Article Number	EAN Code
¼"	12.7	57.2	19	B1	C1	1	1	4932500937	4058546622398
¼"	12.7	70	31.7	B1	C1	1	1	4932501175	4058546638917
¼"	15.8	66.5	19	B2	C1	1	1	4932500938	4058546622404
½"	19	92	50.8	B4	C4	1	1	4932500939	4058546622411
8	16	66.5	31.7	B3	C2	1	1	4932500941	4058546622435
8	19	66.5	31.7	B3	C2	1	1	4932500942	4058546622442
8	22	57	20	B5	C2	1	1	4932500943	4058546622459
12	19	92	50.8	B4	C3	1	1	4932500944	4058546622466

Template profile bits with carbide insert knives

Pattern router bit with two replaceable carbide insert knives. With top bearing for precise self-guiding along a template without the need of a guide bush for pattern duplication, to cut repeatable and complex shapes.
Knives have 4 x 35° cutting edges so can be rotated to give double the life.
The knife has a 3° cutting angle for plunge and high precision cuts.
Especially suited to trimming laminate.

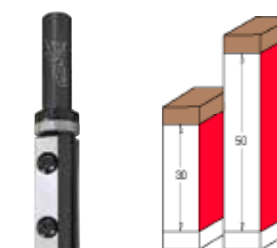

Shank diameter (mm)	Diameter (mm)	Total length (mm)	Working length (mm)	Bearing type	Collar type	Knives type	Screws / Nuts type	Pack quantity	Min. order quantity	Article Number	EAN Code
½"	19	100	48.3	B4	C4	K2	S2	1	1	4932500948	4058546622503
8	16	80	35	B3	C2	K1	S1	1	1	4932500949	4058546622510
12	19	100	48.3	B4	C4	K2	S2	1	1	4932500950	4058546622527

Template /Flush trimming bits with carbide insert knives

Double bearing straight router bit with two replaceable carbide insert knives.
The double bearing gives the flexibility to place templates either on top or at the bottom of the material. It also can provide for more stability when high material removal is required.
Knives have 4 x 35° cutting edges so can be rotated to give double the life.

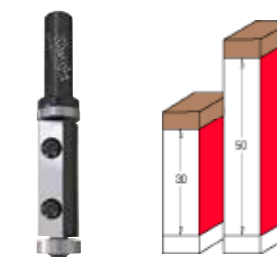

Shank diameter (mm)	Diameter (mm)	Total length (mm)	Working length (mm)	Bearing type	Collar type	Knives type	Screws / Nuts type	Washers / Spacers type	Pack quantity	Min. order quantity	Article Number	EAN Code
½"	19	110	50	B4, B6	C4	K4	S2, S3	W4	1	1	4932500945	4058546622473
8	19	90	30	B6, B7	C2	K3	S2, S3	W4	1	1	4932500946	4058546622480
12	19	110	50	B4, B6	C4	K4	S2, S3	W4	1	1	4932500947	4058546622497

Chamfer bits

Carbide 2 flute bit with bottom bearing for self-guiding with no need for a template.

For producing 45° chamfer edges on the corners of a workpiece.

After resharpening replace the bearing as follows. Bearing B8 Ø 9,5mm 4932501062 with bearing B9 Ø 9,3mm 4932501063. Bearing B10 Ø 12,7mm 4932501064 with bearing B12 Ø 12,5mm 4932501066.

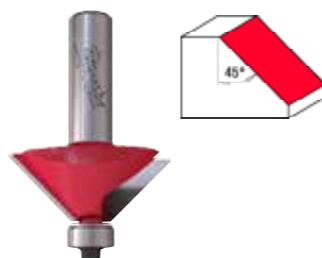

Shank diameter (mm)	Diameter (mm)	Total length (mm)	Working length (mm)	Cutting Angle (°)	Bearing type	Screws / Nuts type	Washers / Spacers type	Pack quantity	Min. order quantity	Article Number	EAN Code
¼"	31.7	53.3	9.5	45°	B10	S5	W2	1	1	4932501003	4058546623050
½"	31.7	53.3	9.5	45°	B10	S6	W3	1	1	4932501210	4058546639266
½"	45	66.5	18	45°	B10	S5	W2	1	1	4932501004	4058546623067
8	31.7	53.3	9.5	45°	B10	S5	W2	1	1	4932501005	4058546623074
8	45	60.5	18	45°	B10	S5	W2	1	1	4932501006	4058546623081
12	31.7	53.3	10	45°	B10	S5	W2	1	1	4932501211	4058546639273
12	65	77.1	26	45°	B10	S5	W2	1	1	4932501007	4058546623098

Combi chamfer/trimming bits

Especially suited to chamfering laminate.

Ref 4932 5010 01 is supplied with 3 carbide cutting edges. Special short cutting length especially for chamfering plastic laminates and all wood types.

Ref 4932 5010 0 is supplied with 2 carbide cutting edges. Combination trim and chamfer cutter. Top side chamfers and bottom of the cutter will trim.

After resharpening replace the bearing as follows. Bearing B8 Ø 9,5mm 4932501062 with bearing B9 Ø 9,3mm 4932501063.

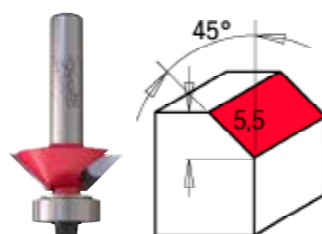

Shank diameter (mm)	Diameter (mm)	Total length (mm)	Working length (mm)	Cutting Angle (°)	Bearing type	Screws / Nuts type	Washers / Spacers type	Pack quantity	Min. order quantity	Article Number	EAN Code
¼"	17.5	51	9.5	22°	B8	S5	W1	1	1	4932501001	4058546623036
8	27	51.5	5.5	25°	B18	S5	W2	1	1	4932501002	4058546623043

Chamfer bits with carbide insert knives

Chamfer router bit with two replaceable carbide insert knives. With bottom bearing for self-guiding, with no need for a template.

For producing 45° chamfer edges on the corners of a workpiece.

Ideal for chamfering plastic laminates and all wood types.

Knives have 4 x 45° cutting edges so can be rotated in 90° increments to give 4x the life.

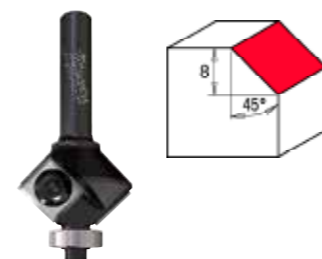

Shank diameter (mm)	Diameter (mm)	Total length (mm)	Working length (mm)	Cutting Angle (°)	Knives type	Screws / Nuts type	Washers / Spacers type	Pack quantity	Min. order quantity	Article Number	EAN Code
8	29	60	8	45°	K6	S2, S6	W5	1	1	4932501008	4058546623104

V Groove bits

Carbide 2 flute bit for multiple tasks. V grooves for decorative trim, chamfering edges and engraving/sign writing.

References 4932500955 and 4932500956 are particularly made for scoring V-grooves in aluminium composite panels or similar sandwich material so that it can be folded.

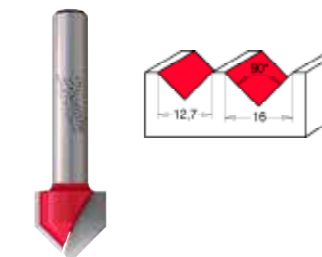

Shank diameter (mm)	Diameter (mm)	Total length (mm)	Working length (mm)	Cutting Angle (°)	Pack quantity	Min. order quantity	Article Number	EAN Code
¼"	12.7	44.5	12.7 / 6.35	90°	1	1	4932500951	4058546622534
½"	16	63.5	12.7 / 8	90°	1	1	4932500952	4058546622541
8	16	52.8	12.7 / 8	90°	1	1	4932500953	4058546622558
8	31.7	63.5	19 / 15.88	90°	1	1	4932500954	4058546622565
¼"	18	60	7.4	90°	1	1	4932500955	4058546622572
8	18	60	7.4	90°	1	1	4932500956	4058546622589

V Groove bits with carbide insert knives

V groove router bit with one replaceable carbide insert knife.

Knives have 4 x 35° cutting edges so can be rotated to give double the life.

Ideal for sign writing and engraving.



Shank diameter (mm)	Diameter (mm)	Total length (mm)	Working length (mm)	Cutting Angle (°)	Knives type	Screws / Nuts type	Pack quantity	Min. order quantity	Article Number	EAN Code
¼"	23	60	11	90°	K5	S4	1	1	4932500957	4058546622596
8	23	60	11	90°	K5	S4	1	1	4932500958	4058546622602

Laser point bits

Solid carbide head with 3 cutting edges for maximum lifetime.

Cuts fine lines with high accuracy making it ideal for sign writing and engraving.

3 cutting edges reduce the risk of burning.

Suitable for free hand use.

Multi axis CNC grinding process produces a ultra sharp cutting edge geometry for best edge retention

- Stays Sharper Longer.

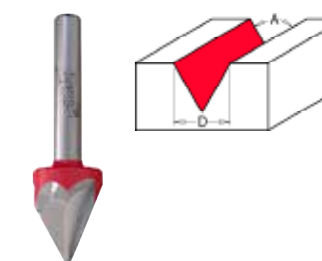

Shank diameter (mm)	Diameter (mm)	Total length (mm)	Working length (mm)	Cutting Angle (°)	Pack quantity	Min. order quantity	Article Number	EAN Code
¼"	12.7	57.2	11	60°	1	1	4932500959	4058546622619
8	12.7	57.2	11	60°	1	1	4932500960	4058546622626

Decorative beading bits

Carbide 2 flute bit.
Produces a decorative bead effect for panels, door and drawer applications.

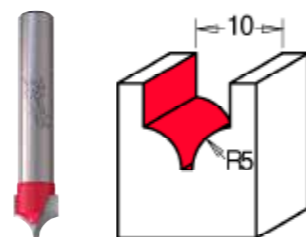

Shank diameter (mm)	Diameter (mm)	Total length (mm)	Working length (mm)	Radius (mm)	Pack quantity	Min. order quantity	Article Number	EAN Code
1/4"	10 / 1.3	50	10	5	1	1	4932500961	4058546622633
8	10 / 1.3	50	10	5	1	1	4932500962	4058546622640
8	19 / 6.35	68	13	3.2	1	1	4932500963	4058546622657

Radius Cove bits

2 carbide edges ensure clean, smooth round bottom grooves. These can be used to plunge into the middle of the workpiece to create grooves as opposed to cove bits with a bearing.
Bits with Ø 6 and 6,4mm diameter are solid carbide for better durability.

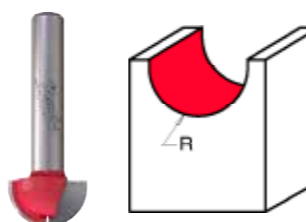

Shank diameter (mm)	Diameter (mm)	Total length (mm)	Working length (mm)	Radius (mm)	Pack quantity	Min. order quantity	Article Number	EAN Code
1/4"	6.4	50.8	12.7	3.2	1	1	4932500964	4058546622664
1/4"	12.7	50.8	9.5	6.35	1	1	4932500965	4058546622671
1/2"	19	73	31.7	9.5	1	1	4932500966	4058546622688
8	6	73	31.7	3	1	1	4932500967	4058546622695
8	9.5	50.8	6.2	4.75	1	1	4932500968	4058546622701
8	12.7	50.8	9.3	6.35	1	1	4932500969	4058546622718
8	15.8	50.8	9.3	8	1	1	4932500970	4058546622725
8	19	50.8	11.3	9.5	1	1	4932500971	4058546622732
8	20	63.5	25.4	10	1	1	4932500972	4058546622749
8	25	68	31.7	12.5	1	1	4932500973	4058546622756
8	30	63.5	19	15	1	1	4932500974	4058546622763
12	19	73	31.7	9.5	1	1	4932500975	4058546622770

Dovetail bits

2 carbide edges ensure clean cuts.
For dovetail joints.

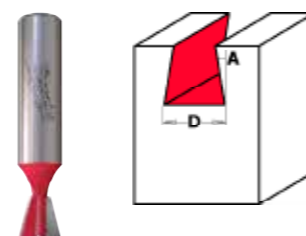

Shank diameter (mm)	Diameter (mm)	Total length (mm)	Working length (mm)	Cutting Angle (°)	Pack quantity	Min. order quantity	Article Number	EAN Code
1/4"	12.7	52.4	12.7	14°	1	1	4932500976	4058546622787
1/2"	12.7	63.5	12.7	14°	1	1	4932500977	4058546622794
8	12.7	52.4	12.7	14°	1	1	4932500978	4058546622800
8	19	60.3	22	7°	1	1	4932500979	4058546622817

Slot cutter arbor and cutters

Slot cutter arbors are delivered with bearing, nut and three washers/spacers (1/3/4mm); the required 3 wing slot cutters need to be ordered extra.

3 wing carbide tipped slot cutters with anti kickback design for maximum safety come in a wide range of widths.

All cutters have a Ø 8mm bore and a maximum cutting depth of 12.8mm.

With red anti friction coating to prevent resin build up and jamming.

Applications: grooves for biscuit joining, slots for weather proofing on windows and door frames and tongue and groove joints.

Cobalt infused micro grain tungsten carbide for best durability and lifetime, thicker carbide so suitable for multiple resharpenings.

Carbide is brazed onto the body using a triple layer process (silver-copper-silver) to give the strongest bond.

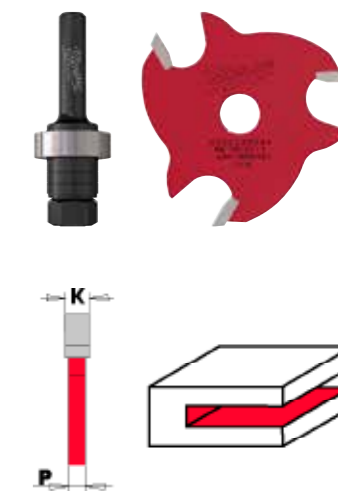

Description	Shank diameter (mm)	Total length (mm)	Bearing type	Screws / Nuts type	Washers / Spacers type	Pack quantity	Min. order quantity	Article Number	EAN Code
Router bit 1/4" shank Slot Cut Arbor-1pc	1/4"	61	B5	S7	W6, W7, W8	1	1	4932500980	4058546622824
Router bit 1/2" shank Slot Cut Arbor-1pc	1/2"	67.5	B5	S7	W6, W7, W8	1	1	4932500981	4058546622831
Router bit 8mm shank Slot Cut Arbor-1pc	8	61	B5	S7	W6, W7, W8	1	1	4932500982	4058546622848
Router bit 12mm shank Slot Cut Arbor-1pc	12	67.5	B5	S7	W6, W7, W8	1	1	4932500983	4058546622855

Description	Shank diameter (mm)	Diameter (mm)	Cutting width (mm)	Pack quantity	Min. order quantity	Article Number	EAN Code
Slot Cutter 1,5mm	8	47.6	1.5	1	1	4932500984	4058546622862
Slot Cutter 2mm	8	47.6	2	1	1	4932500985	4058546622879
Slot Cutter 2,5mm	8	47.6	2.5	1	1	4932500986	4058546622886
Slot Cutter 3mm	8	47.6	3	1	1	4932500987	4058546622893
Slot Cutter 3,2mm	8	47.6	3.2	1	1	4932500988	4058546622909
Slot Cutter 3,5mm	8	47.6	3.5	1	1	4932500989	4058546622916
Slot Cutter 4mm	8	47.6	4	1	1	4932500990	4058546622923
Slot Cutter 5mm	8	47.6	5	1	1	4932500991	4058546622930
Slot Cutter 6mm	8	47.6	6	1	1	4932500992	4058546622947
Slot Cutter 6,4mm	8	47.6	6.4	1	1	4932500993	4058546622954

Tongue & Groove Cutter

One piece design cutter for producing tongue and groove joints.
Makes tongue and groove cuts in wood up to 19mm thickness.
Maximum cutting depth 12.8mm.
Replacement slot cutter 6,4mm ref. 4932500993.
Ref 4932501177 is only the replacement shank

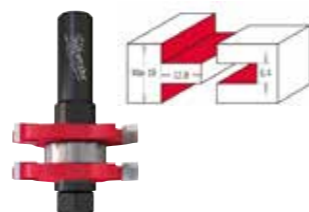

Description	Shank diameter (mm)	Diameter (mm)	Total length (mm)	Working length (mm)	Cutting width (mm)	Bearing type	Collar type	Screws / Nuts type	Pack quantity	Min. order quantity	Article Number	EAN Code
Router bit 1/2" shank Tongue & Groove Cutter 47,6/19mm	1/2"	47.6	71	19	19	B5	C6	S7	1	1	4932501176	4058546638924
Router bit 1/2" shank Tongue and Groove Arbor	1/2"	Shank only	-	-	-	-	C6	-	1	1	4932501177	4058546638931

Mitre lock bits

This carbide 2 flute bit is used to make strong right angle glue joints as well as parallel joints in boxes and frame production.
Maximum 19mm material thickness.

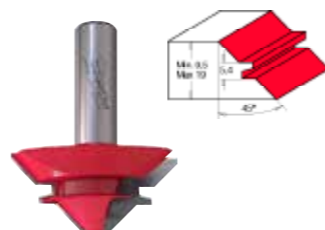

Shank diameter (mm)	Diameter (mm)	Total length (mm)	Working length (mm)	Cutting Angle (°)	Cutting width (mm)	Pack quantity	Min. order quantity	Article Number	EAN Code
1/2"	50.8	60.3	21	45°	9.5 / 19	1	1	4932500994	4058546622961
12	50.8	60.3	21	45°	9.5 / 19	1	1	4932500995	4058546622978

Rebate / mortising bits

Carbide 2 flute rebate bit with bottom bearing for self-guiding, suitable for rebating straight and curved workpieces.
Ideal for producing rebates and small tenons.

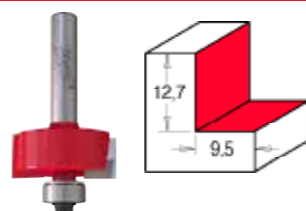

Shank diameter (mm)	Diameter (mm)	Total length (mm)	Working length (mm)	Cutting width (mm)	Bearing type	Screws / Nuts type	Washers / Spacers type	Pack quantity	Min. order quantity	Article Number	EAN Code
1/4"	31.7	58.4	12.7	9.5	B10	S5	W2	1	1	4932500996	4058546622985
1/2"	31.7	61.2	12.7	9.5	B10	S5	W2	1	1	4932501208	4058546639242
8	31.7	58.4	12.7	9.5	B10	S5	W2	1	1	4932500997	4058546622992
12	31.7	61.2	12.7	9.5	B10	S5	W2	1	1	4932501209	4058546639259

Rebate / mortising bits - vario

Carbide 2 flute rebate bit with bottom bearing for self-guiding, suitable for rebating straight and curved workpieces.
Ideal for producing rebates and small tenons.
The bearings can be interchanged to produce different depths of rebate.
Set includes rebating cutter, 6 bearings (diameter: 12,7/15,88/19,05/22/28,5/34,9), shield and fastening screw. Replacement bearing set ref. 4932501000.
When assembling ensure the black bearing washer is the right side up to correspond with the bearing rotation. Improper assembly can cause the screw to become loose.

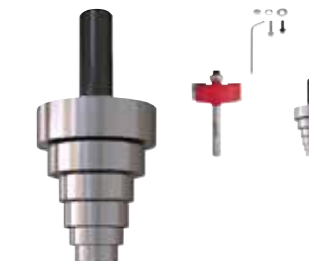

Shank diameter (mm)	Diameter (mm)	Working length (mm)	Cutting width (mm)	Bearing type	Screws / Nuts type	Washers / Spacers type	Pack quantity	Min. order quantity	Article Number	EAN Code
1/4"	34.9	12.7	0 - 12.7	B8	S5	W1	1	1	4932500998	4058546623005
8	34.9	12.7	0 - 12.7	B8	S5	W1	1	1	4932500999	4058546623012
6pcs Bearing set							6	1	4932501000	4058546623029

Roundover Ovolo bits

Carbide 2 fluted ovolo cutters are used to round over edges of materials to avoid sharp edges or to add a decorative touch to the workpiece.
Bearing guided so no need for a side fence.
If the router bit is lowered a top step can be produced.
After resharpening replace the bearing as follows. Bearing B10 Ø 12,7mm 4932501064 with bearing B12 Ø 12,5mm 4932501066.
Safety tip : ensure to keep the black bearing washer right side up to correspond with the bearing rotation when reassembling the bearing. Improper reassembly can cause the bit to unscrew.

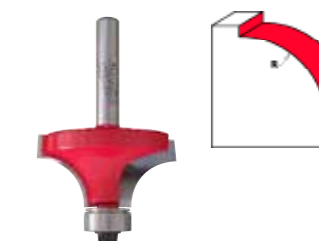

Shank diameter (mm)	Diameter (mm)	Total length (mm)	Working length (mm)	Radius (mm)	Bearing type	Screws / Nuts type	Washers / Spacers type	Pack quantity	Min. order quantity	Article Number	EAN Code
1/4"	15.9	54	12.7	1.6	B10	S5	W1	1	1	4932501013	4058546623159
1/4"	19.1	54	12.7	3.2	B10	S5	W2	1	1	4932501014	4058546623166
1/4"	22.2	54	12.7	4.75	B10	S5	W2	1	1	4932501015	4058546623173
1/4"	25.4	54	12.7	6.35	B10	S5	W2	1	1	4932501016	4058546623180
1/4"	28.6	54	12.7	8	B10	S5	W2	1	1	4932501017	4058546623197
1/4"	31.7	57.3	16	9.5	B10	S5	W2	1	1	4932501018	4058546623203
1/4"	38.1	61	19	12.7	B10	S5	W2	1	1	4932501019	4058546623210
1/2"	31.7	63.7	16	9.5	B10	S5	W2	1	1	4932501212	4058546639280
1/2"	44.5	70	22	16	B10	S5	W2	1	1	4932501020	4058546623227
1/2"	50.8	73	25.4	19	B10	S5	W2	1	1	4932501021	4058546623234
8	15.9	54	12.7	1.6	B10	S5	W1	1	1	4932501022	4058546623241
8	16.7	54.4	12.7	2	B10	S5	W1	1	1	4932501023	4058546623258
8	18.7	52.5	12.7	3	B10	S5	W1	1	1	4932501024	4058546623265
8	19.1	54	12.7	3.2	B10	S5	W2	1	1	4932501025	4058546623272
8	22.2	54	12.7	4.75	B10	S5	W2	1	1	4932501026	4058546623289
8	25.4	54	12.7	6.35	B10	S5	W2	1	1	4932501027	4058546623296
8	28.6	54	12.7	8	B10	S5	W2	1	1	4932501028	4058546623302
8	31.7	57.3	16	9.5	B10	S5	W2	1	1	4932501029	4058546623319
8	38.1	61	19	12.7	B10	S5	W2	1	1	4932501030	4058546623326
8	44.5	63.5	22	16	B10	S5	W2	1	1	4932501031	4058546623333
12	31.7	63.7	16	9.5	B10	S5	W2	1	1	4932501213	4058546639297
12	50.8	73	25.4	19	B10	S5	W2	1	1	4932501032	4058546623340

Hinge boring bits

4 carbide cutting edges with center point for accurate positioning.
Right hand rotation.
Application: recessing for circular hinges.
Suitable for soft/hard woods, MDF and laminated boards.



Shank diameter (mm)	Diameter (mm)	Total length (mm)	Pack quantity	Min. order quantity	Article Number	EAN Code
1/2"	35	60	1	1	4932501040	4058546623425
8	15	60	1	1	4932501041	4058546623432
8	20	60	1	1	4932501042	4058546623449
8	25	60	1	1	4932501043	4058546623456
8	30	60	1	1	4932501044	4058546623463
8	35	60	1	1	4932501045	4058546623470
8	40	60	1	1	4932501046	4058546623487
12	35	60	1	1	4932501047	4058546623494

Sets

Cobalt infused micro grain tungsten carbide for best durability and lifetime, thicker carbide so suitable for multiple resharpenings.

Carbide is brazed onto the body using a triple layer process (silver-copper-silver) to give the strongest bond.

Multi axis CNC grinding process produces a ultra sharp cutting edge geometry for best edge retention - Stays Sharper Longer.

Anti-friction coating reduces binding, friction and heat build up for cooler cuts; it also protects the bit against corrosion and accumulation of resin.

Anti-Kickback Shoulder controls depth of cut and minimises kickback.



Description	Shank diameter (mm)	Pack quantity	Min. order quantity	Article Number	EAN Code
Router bit 1/4" shank two flute 5 pcs. straight bit set (4/6,35/8/10/12,7mm) Set contains the following router bit references: 4932500853, 4932500857, 4932500859, 4932500862, 4932500864	1/4"	5	1	4932501049	4058546623517
Router bit 1/4" shank two flute 7 pcs. mixed bit set Set contains the following router bit references: 4932500924, 4932500938, 4932500965, 4932501003, 4932500996, 4932501033, 4932501018	1/4"	7	1	4932501048	4058546623500
Router bit 1/2" shank two flute 7 pcs mixed bit set Set contains the following router bit references: 4932500870, 4932500873, 4932500926, 4932500966, 4932501210, 4932501208, 4932501212	1/2"	7	1	4932501051	4058546623531
Router bit 8mm shank two flute 7pcs. mixed bit set Set contains the following router bit references: 4932500892, 4932500930, 4932500854, 4932500968, 4932500997, 4932501005, 4932501027	8	7	1	4932501052	4058546623548
Router bit 8mm shank two flute 5 pcs. straight bit set (4/6/8/10/12mm) Set contains the following router bit references: 4932500877, 4932500879, 4932500882, 4932500884, 4932500886	8	5	1	4932501053	4058546623555
Router bit 12mm shank two flute 7 pcs. mixed bit set Set contains the following router bit references: 4932500902, 4932500903, 4932500932, 4932500975, 4932501209, 4932501211, 4932501213	12	7	1	4932501054	4058546623562

Finger pull bits

Carbide 2 flute bit to add finger pulls to wood door/cabinet door fronts instead of attaching a knob.
Recommended to be used at a reduced speed and only with a router table.

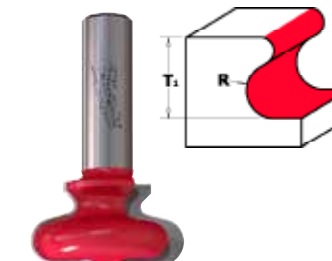

Shank diameter (mm)	Diameter (mm)	Total length (mm)	Working length (mm)	Radius (mm)	Pack quantity	Min. order quantity	Article Number	EAN Code
1/2"	19.05 / 9.5	57.2	19.05	4.76 / 2.4	1	1	4932501009	4058546623111
1/2"	38.1 / 17	61.8	20.7	6 / 1.8	1	1	4932501010	4058546623128
8	19.05 / 9.5	57.2	19.05	4.76 / 2.4	1	1	4932501011	4058546623135
8	38.1 / 17	55.5	20.7	6 / 1.8	1	1	4932501012	4058546623142

Cove bits

2 carbide edges ensure a clean concave rounded profile.
Bearing guided so no need for a side fence.

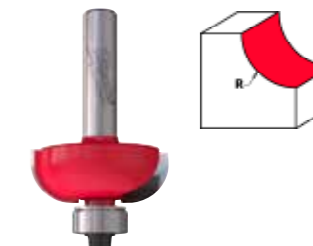

Shank diameter (mm)	Diameter (mm)	Total length (mm)	Working length (mm)	Radius (mm)	Bearing type	Screws / Nuts type	Washers / Spacers type	Pack quantity	Min. order quantity	Article Number	EAN Code
1/4"	31.7	54.2	12.7	9.5	B10	S5	W2	1	1	4932501033	4058546623357
1/4"	38.1	57.7	15.5	12.7	B10	S5	W2	1	1	4932501034	4058546623364
8	31.7	54.2	12.7	9.5	B10	S5	W2	1	1	4932501035	4058546623371
8	38.1	57.7	15.5	12.7	B10	S5	W2	1	1	4932501036	4058546623388

Roman Ogee / beading bits

2 carbide edges ensure a clean S shaped profile.
Bearing guided so no need for a side fence.
For best results multiple passes are recommended.
Ref 4932501038 and 4932501039 has a extra step for more decorative possibilities.

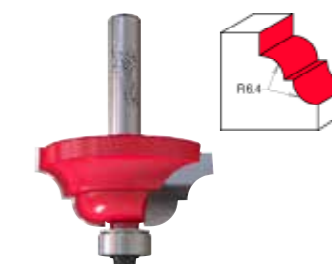

Shank diameter (mm)	Diameter (mm)	Radius (mm)	Pack quantity	Min. order quantity	Article Number	EAN Code
8	34	4.8 / 3.6	1	1	4932501039	4058546623418
8	38.1	6.4 / 4	1	1	4932501037	4058546623395
8	42.8	6.4 / 4	1	1	4932501038	4058546623401

Replacement bearings

MILWAUKEE® replacement ball bearings are designed to spin at high RPM and are double shielded for best performance. Use original MILWAUKEE® bearings to replace worn out bearings on router bits.



Bearing type	Diameter (mm)	Bore size (mm)	Height (mm)	Pack quantity	Min. order quantity	Article Number	EAN Code
B1	12.7	6.35	4.8	1	1	4932501055	4058546623579
B2	15.88	6.35	5	1	1	4932501056	4058546623586
B3	16	8	5	1	1	4932501057	4058546623593
B4	19	12.7	4	1	1	4932501058	4058546623609
B5	22	8	7	1	1	4932501059	4058546623616
B6	19	6	6	1	1	4932501060	4058546623623
B7	19	8	6	1	1	4932501061	4058546623630
B8	9.5	4.76	3.2	1	1	4932501062	4058546623647
B9	9.3	4.76	3.2	1	1	4932501063	4058546623654
B10	12.7	4.76	5	1	1	4932501064	4058546623661
B11	19	6.35	7	1	1	4932501065	4058546623678
B12	12.7	4.76	5	1	1	4932501066	4058546623685
B13	13	5	4	1	1	4932501068	4058546623708
B14	6.35	3.17	2.8	1	1	4932501178	4058546638948
B15	15.88	4.76	5	1	1	4932501067	4058546623692

Carbide knives

Hardness (HV10) 1.920. Transverse rupture strength 2,600 N/mm².

High cutting efficiency for long lifetime.

Excellent resistance to corrosion and mechanical wear.

The knives need to be first pressed into the seating position and then they can be tightened to the specified torque. Thread M2.5=1Nm, M3=1.2Nm, M3.5=1.8Nm, M4=2.7Nm, M5=5.3Nm

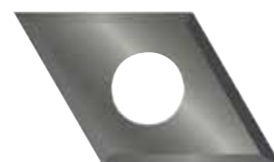

Knives type	Total length (mm)	Pack quantity	Min. order quantity	Article Number	EAN Code
K1	28 x 12	10	1	4932501069	4058546623715
K2	48.3 x 12	10	1	4932501070	4058546623722
K3	30 x 15	10	1	4932501071	4058546623739
K4	50 x 12	10	1	4932501072	4058546623746
K5	14 x 14	10	1	4932501073	4058546623753
K6	12 x 12	10	1	4932501074	4058546623760

Spare parts: screws/nuts

Replacement spare parts for router bits (screws/nuts/stop collars/spacers/bushes). Reduction bushes fit to the collet to allow the insertion of smaller shank router bits.



Description	Washers / Spacers type	Screws / Nuts type	Collar type	Pack quantity	Min. order quantity	Article Number	EAN Code
Router bit screw S1 TX M4x6-1pc		S1		1	1	4932501075	4058546623777
Router bit screw S2 TX M3x6-1pc		S2		1	1	4932501076	4058546623784
Router bit screw S3 M4x6-1pc		S3		1	1	4932501077	4058546623791
Router bit screw S4 TX M5x5x5-1pc		S4		1	1	4932501078	4058546623807
Router bit screw S5 1/8x3/8-1pc		S5		1	1	4932501079	4058546623814
Router bit screw S6 M3x6-1pc		S6		1	1	4932501080	4058546623821
Router bit nut S7 M8-1pc		S7		1	1	4932501081	4058546623838
Router bit screw 8mm shank-1pc		S8		1	1	4932501179	4058546638955
Router bit stop collar C1 1/4"-1pc			C1	1	1	4932501085	4058546623876
Router bit stop collar C2 8mm-1pc			C2	1	1	4932501086	4058546623883
Router bit stop collar C3 12mm-1pc			C3	1	1	4932501087	4058546623890
Router bit stop collar C4 1/2"-1pc			C4	1	1	4932501088	4058546623906
Router bit collar/spacer C5 E 9x3,25x1,6mm-1pc			C5	1	1	4932501089	4058546623913
Router bit stop collar C6 6,1x3,17-1pc			C6	1	1	4932501180	4058546638962
Router bit washer W1 3/8"-1pc	W1			1	1	4932501090	4058546623920
Router bit washer W2 1/2"-1pc	W2			1	1	4932501091	4058546623937
Router bit washer W3 19 x 1/4"-1pc	W3			1	1	4932501092	4058546623944
Router bit washer W4 M4-1pc	W4			1	1	4932501093	4058546623951
Router bit washer W5 M3-1pc	W5			1	1	4932501094	4058546623968
Router bit spacer W6-1pc	W6			1	1	4932501082	4058546623845
Router bit spacer W7-1pc	W7			1	1	4932501083	4058546623852
Router bit spacer W8-1pc	W8			1	1	4932501084	4058546623869
Router bit reduction bush 8mm - 6mm-1pc				1	1	4932501181	4058546638979
Router bit reduction bush 8mm - 1/4"-1pc				1	1	4932501182	4058546638986
Router bit reduction bush 1/2 - 1/4"-1pc				1	1	4932501183	4058546638993
Router bit reduction bush 12mm - 8mm-1pc				1	1	4932501184	4058546639006

CIRCULAR SAW BLADES

CUTS COOLER. INCREASED ACCURACY. LONGER LIFE.



**COBALT INFUSED TUNGSTEN CARBIDE TEETH
PRODUCE SHARP AND CLEAN CUTS**



Circular saw blades for hand held circular saws

PTFE coating: Cuts cooler, non stick for quicker cuts. Protects against corrosion and accumulation of resin.

Laser cut vibration slots: Low vibration and increased accuracy.

High grade laser cut steel: Guaranteed accuracy.

Premium cobalt infused tungsten carbide: Sharp and clean cuts.

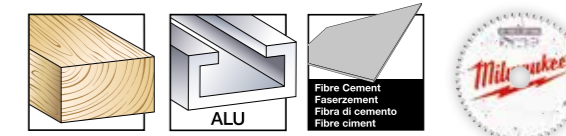

Blade diameter (mm)	Bore size (mm)	No. of teeth	Cutting width (kerf) (mm)	Hook angle	Tooth form	Thin kerf*	All wood types*	Abrasive Particleboard, Fibre cement Board, Fiberglass	Plastics	Non ferrous metals profiles alu	Fast cut	Clean Cut	Pack quantity	Min. order quantity	Article Number	EAN Code
140	20	18	1.6	+18°	ATB	✓	✓				✓		1	1	4932471310	4058546289386
		24	2.2	+15°	ATB		✓				✓		1	1	4932471290	4058546289188
160	20	48	2.2	+5°	ATB		✓					✓	1	1	4932471291	4058546289195
		52	2.2	-5°	TF				✓	✓		✓	1	1	4932471292	4058546289201
		4	1.8	+10°	D				✓		✓		1	1	4932471293	4058546289218
165	5/8"	24	1.6	+15°	ATB	✓	✓				✓		1	1	4932471311	4058546289393
		40	1.6	+18°	ATB	✓	✓				✓		1	1	4932471312	4058546289409
165	20	4	2.2	10°	D			✓			✓	✓	1	1	4932493217	4058546480882
		24	1.6	+15°	ATB	✓	✓				✓		1	1	4932471931	4058546298302
		40	1.6	+18°	ATB	✓	✓				✓		1	1	4932471932	4058546298319
		52	1.6	+2°	ATB	✓			✓	✓		✓	1	1	4932479087	4058546368814
		24	2.2	+15°	ATB		✓				✓		1	1	4932471294	4058546289225
		48	2.2	+5°	ATB		✓				✓		1	1	4932471295	4058546289232
165	30	52	2.2	-5°	TF				✓	✓		✓	1	1	4932471296	4058546289249
		24	1.8	+15°	ATB	✓	✓				✓		1	1	4932399909**	4002395365647
184	5/8"	24	1.6	+15°	ATB	✓	✓				✓		1	1	4932471378	4058546290061
		40	2.1	+15°	ATB	✓	✓				✓		1	1	4932471379	4058546290078
184	30	24	1.6	+15°	ATB	✓	✓				✓		1	1	4932471297	4058546289256
		40	2.1	+10°	ATB	✓	✓				✓		1	1	4932471298	4058546289263
		54	2.4	-5°	TF				✓	✓		✓	1	1	4932471299	4058546289270
190	30	24	1.6	+15°	ATB	✓	✓				✓		1	1	4932471300	4058546289287
		24 **	1.8	+12°	ATB	✓	✓				✓		1	1	4932498976	4058546528454
		36	1.6	+15°	ATB	✓	✓				✓		1	1	4932471301	4058546289294
190	30	48	2.1	+10°	ATB	✓	✓				✓		1	1	4932471380	4058546290085
		54	2.4	-5°	TF				✓	✓		✓	1	1	4932471303	4058546289317
		4	1.8	+10°	D				✓		✓		1	1	4932471304	4058546289324
		16	2.4	+15°	ATB	✓	✓				✓		1	1	4932471324	4058546289522
210	30	48	2.8	+10°	ATB	✓	✓				✓		1	1	4932471325	4058546289539
		24	2.4	+15°	ATB		✓				✓		1	1	4932471305	4058546289331
		36	2.4	+15°	ATB		✓				✓		1	1	4932471306	4058546289348
		48	2.4	+10°	ATB		✓				✓		1	1	4932471307	4058546289355
		60	2.4	+10°	ATB		✓				✓		1	1	4932471308	4058546289362
235	30	60	2.4	-5°	TF				✓	✓		✓	1	1	4932471309	4058546289379

Circular Saw Blade Twin Packs

165 x 5/8" Twin pack set (2pc) 2 x 165x5/8"x24 tooth, fast cut wood blade (4932471311)	2	1	4932479836	4058546376307
165 x 5/8" Twin pack set (2pc) 1 x 165x5/8"x24 tooth, fast cut wood blade (4932471311) + 1 x 165x5/8"x40 tooth, clean cut wood blade (4932471312)	2	1	4932479837	4058546376314
165 x 20 mm Twin pack set (2pc) 2 x 165x20x40 tooth, fast and clean cut wood blade (4932471932)	2	1	4932492433	4058546418007
190 x 30 mm Twin pack set (2pc) 1 x 190x30x24 tooth, fast cut wood blade (4932471300) + 1 x 190x30x48 tooth, clean cut wood blade (4932471380)	2	1	4932479574	4058546373689
190 x 30 mm Twin pack set (2pc) 2 x 190x30x24 tooth, fast cut wood blade (4932471300)	2	1	4932479804	4058546375980

Circular saw blades for mitre saws

PTFE coating: Cuts cooler, non stick for quicker cuts. Protects against corrosion and accumulation of resin.
Laser cut vibration slots: Low vibration and increased accuracy. Slots are filled with polyurethane and act as shock absorbers by isolating the teeth from vibration.
High grade laser cut steel: Guaranteed accuracy.
Premium cobalt infused tungsten carbide: Sharp and clean cuts.



Blade diameter (mm)	Bore size (mm)	No. of teeth	Cutting width (kerf) (mm)	Hook angle	Tooth form	All wood types*	Plastics	Non ferrous metals profiles alu	Fast cut	Clean Cut	Pack quantity	Min. order quantity	Article Number	EAN Code
190	30	40	2.4	-5°	ATB	✓			✓		1	1	4932471314	4058546289423
		54	2.4	-5°	TF		✓	✓		✓	1	1	4932471303	4058546289317
216	30	24	2.4	-5°	ATB	✓			✓		1	1	4932471315	4058546289430
		48	2.4	-5°	ATB	✓			✓		1	1	4932471316	4058546289447
		60	2.4	-5°	ATB	✓			✓		1	1	4932471317	4058546289454
250	30	80	2.4	-5°	TF		✓	✓		✓	1	1	4932471319	4058546289478
		40	2.8	+15°	ATB	✓			✓		1	1	4932472015	4058546324117
254	30	60	2.8	+15°	ATB	✓				✓	1	1	4932472016	4058546324124
		60	3.0	-5°	ATB	✓			✓		1	1	4932471320	4058546289485
305	30	80	3.0	-5°	TF		✓	✓		✓	1	1	4932471318	4058546289461
		60	3.0	-5°	ATB	✓			✓		1	1	4932471321	4058546289492
		96	3.0	-5°	TF		✓	✓		✓	1	1	4932471323	4058546289515

Circular Saw Blade Twin Packs

216 x 30 mm Twin pack set (2pc)

1 x 216x30x48 tooth, fast cut wood blade (4932471316) + 1 x 216x30x60 tooth, clean cut wood blade (4932471317) 2 1 4932479575 4058546373696

254 x 30 mm Twin pack set (2pc)

1 x 254x30x60 tooth, fast cut wood blade (4932471320) + 1 x 254x30x80 tooth, clean cut aluminium blade (4932471318) 2 1 4932479576 4058546373702

Thin Kerf: Cordless optimised, extra thin cutting width for maximum runtime
All wood types: Soft/ hardwood, plywood, laminated chipboard, melamine, MDF

Circular saw blades for table saws

PTFE coating: Cuts cooler, non stick for quicker cuts. Protects against corrosion and accumulation of resin.
Laser cut vibration slots: Low vibration and increased accuracy. Slots are filled with polyurethane and act as shock absorbers by isolating the teeth from vibration.
High grade laser cut steel: Guaranteed accuracy.
Premium cobalt infused tungsten carbide: Sharp and clean cuts.
**Standard blades without PTFE coating and vibration slots



Blade diameter (mm)	Bore size (mm)	No. of teeth	Cutting width (kerf) (mm)	Hook angle	Tooth form	Thin kerf*	All wood types*	Abrasive Particle-board, Fibre-cement Board, Fiberglass*	Plastics	Non ferrous metals profiles alu	Fast cut	Clean Cut	Pack quantity	Min. order quantity	Article Number	EAN Code
210	30	24	1.9	+25°	ATB	✓	✓				✓		1	1	4932478095	4058546340285

Thin Kerf: Cordless optimised, extra thin cutting width for maximum runtime
All wood types: Soft/ hardwood, plywood, laminated chipboard, melamine, MDF

NITRUS circular saw demolition blades

These blades are specifically designed for tough jobsite applications such as cutting wood with nails and fasteners
Nitrus welded tooth technology ensures a stronger bonding joint and sharper tooth for best lifetime
Diamond cut out cooling slots ensure the blade keeps cool for less distortion, straighter cuts and longest life



Blade diameter (mm)	Bore size (mm)	No. of teeth	Cutting width (kerf) (mm)	Hook angle	Tooth form	Fast cut	Pack quantity	Min. order quantity	Article Number	EAN Code
190	30	24	1.6	+18°	ATB	✓	1	1	4932499376	4058546565404

Circular saw blades for rebar cutter

Blade diameter (mm)	Bore size (mm)	No. of teeth	Cutting width (kerf) (mm)	Pack quantity	Min. order quantity	Article Number	EAN Code
137	28	30	1.6	1	1	4932499702	4058546568665



Circular saw blades for metal

NEW

1. Engineered tooth geometry for optimum performance.
2. Top grade carbide and cermet tooth tips for superior lifetime.
3. Fully hardened and tensioned blade body for accurate cuts.
4. Deep gullets provide rapid and efficient chip removal.
5. Laser cut resin filled expansion slots for noise and vibration dampening.

- Cuts clean. Burr free edges reduce extra finishing processes.
- Cuts cool. The cut material can be handled immediately after cutting.
- Cuts fast. Quicker than all other conventional cutting methods.
- Cost cutter. Less expensive per cut than abrasive discs.
- Reduced noise.
- Reduced vibration.
- Total safety: no sparks, no coolants, cool to touch.



Blade diameter (mm)	Bore size (mm)	No. of teeth	Cutting width (kerf) (mm)	Material wall thickness (mm)	Mild steel	Sheet steel up to 2.5mm	Corrugated steel panels up to 2.5mm	Steel pipe	Stainless steel sheets	Cast iron	Copper	Aluminium	Rebar	Sandwich material (steel, foam, panels)	Pack quantity	Min. order quantity	Article Number	EAN Code
135	20	30	1.6	1-2.5	✓	✓	✓	✓	♦	x	x	x	x	✓	1	1	48404070	045242233786
		50	1.6	1-2.5	x	x	x	x	x	x	✓	✓	x	♦	1	1	48404075	045242233793
150	20	34	1.6	>2.5	✓	✓	✓	✓	♦	x	x	✓	✓	1	1	4932501140	4058546624422	
165	15.87	48	1.6	1-2.5	✓	✓	✓	✓	x	x	x	x	x	1	1	48404220	045242569069	
174	20	36	1.6	1-2.5	✓	✓	✓	✓	x	x	x	x	x	1	1	48404225	045242569052	
		42	1.8	>2.5	✓	x	x	✓	x	x	x	x	x	1	1	4932501141	4058546624439	
203	5/8"	50	1.8	1-2.5	✓	✓	✓	✓	♦	x	x	x	x	1	1	4932501142	4058546624446	
		58	2.4	>2.5	x	x	x	x	x	x	✓	✓	x	♦	1	1	4932501194	4058546639105

- ✓ Most suitable. Recommended for these materials.
- ♦ Suitable. Recommended for intermittent use in these materials. Very good cutting characteristics, but greatly reduced lifetime of the blade.

✘ Not suitable. Not recommended for these materials.

Optimising Blade Life

1. Clamp the workpiece securely to avoid vibration.
2. Do NOT stack or bundle cutting material. The gaps between layers allow for more opportunities to chip the teeth.
The life of the blade is severely affected by this type of cutting.
3. Lower the blade to its maximum cutting capacity and allow the tool to come to full speed before applying the blade to the material.
4. Do NOT force the saw blade into the material. Start gently, then gradually apply enough pressure to avoid sparks.
5. Optimal cutting speed and pressure will produce little or no sparks. Sparking creates heat build up which shortens saw blade life.
6. Keep the cut straight. If following a cut line and you wander off the line, getting back on line may cause side loading of the blade and break teeth. Use an edge guide whenever possible.
7. Do NOT apply side pressure on the blade as this will cause chipping of the teeth.
8. Periodically allow the tool to run free of the cutting material to cool the blade and tool especially when making long cuts or cuts in thick material.



Bandsaw blades

Choosing the right tooth geometry

8/10 Tpi Tooth pitch 2.3/1.8 mm	10 Tpi Tooth pitch 2.5 mm	12/14 Tpi Tooth pitch 1.8/1.4 mm	14 Tpi Tooth pitch 1.8 mm	18 Tpi Tooth pitch 1.4 mm	25 Tpi Tooth pitch 1 mm
FOR CUTTING STOCK 5 to 13 mm	FOR CUTTING STOCK 8 to 13 mm	FOR CUTTING STOCK 4 to 8 mm	FOR CUTTING STOCK 5 to 8 mm	FOR CUTTING STOCK 4 to 5 mm	FOR CUTTING STOCK < 4 mm



Premium Bi-Metal bandsaw blades

Multi pitch Bi-Metal blades with matrix II high speed steel teeth with 8% cobalt outlast conventional blades up to 3 times, requiring fewer blade changes.
Precision formed teeth create fast, clean cuts.
Optimised for cordless bandsaws: More cuts per charge.
Suitable for cutting: Angle iron, galvanised pipe and even tougher steels such as cast iron and stainless steel.

Premium bandsaw blade 1139.83 x 12.7 x 0.51 mm (Corded & M18 Deep Cut)

Material wall thickness (mm)	Tooth pitch (mm)	Teeth per inch	Pack quantity	Min. order quantity	Article Number	EAN Code
5 - 13	3.1 / 2.5	8 / 10	3	1	48390601	045242530298
			25	1	48390605	045242539697
4 - 8	2.1 / 1.8	12 / 14	3	1	48390611	045242530328
			25	1	48390615	045242539703



Premium bandsaw blade 898.52 x 12.7 x 0.51 mm (M18 Compact)

Material wall thickness (mm)	Tooth pitch (mm)	Teeth per inch	Pack quantity	Min. order quantity	Article Number	EAN Code
5 - 13	3.1 / 2.5	8 / 10	3	1	48390609	045242536412
			25	1	48390606	045242537754
4 - 8	2.1 / 1.8	12 / 14	3	1	48390619	045242536429
			25	1	48390616	045242537761



Premium Bi-Metal bandsaw blades

Premium bandsaw blade 685.80 x 12.7 x 0.51 mm (M12 Sub Compact)

Material wall thickness (mm)	Tooth pitch (mm)	Teeth per inch	Pack quantity	Min. order quantity	Article Number	EAN Code
4 - 8	2.1 / 1.8	12 / 14	3	1	48390711	045242536436



Premium bandsaw blade 776.29 x 12.7 x 0.51 mm (M12 Sub Compact)

Material wall thickness (mm)	Tooth pitch (mm)	Teeth per inch	Pack quantity	Min. order quantity	Article Number	EAN Code
4 - 8	2.1 / 1.8	12 / 14	3	1	48390631	045242605125
			25	1	48390636	045242605132
5 - 13	3.1 / 2.5	8 / 10	3	1	48390630	045242605156
			25	1	48390635	045242605163



Bi-Metal bandsaw blades

Suitable for cutting: Angle iron, galvanised pipe and even tougher steels such as cast iron and stainless steel.

Bandsaw blade 1139.83 x 12.7 x 0.51 mm (Corded & M18 FUEL™)

Material wall thickness (mm)	Tooth pitch (mm)	Teeth per inch	Pack quantity	Min. order quantity	Article Number	EAN Code
≥ 8	2.5	10	3	1	48390501	045242132096
5 - 8	1.8	14	3	1	48390511	045242132164
4 - 5	1.4	18	3	1	48390521	045242132263
≤ 4	1.0	25	3	1	48390531	045242132362



Bandsaw blade 898.52 x 12.7 x 0.51 mm (M18)

Material wall thickness (mm)	Tooth pitch (mm)	Teeth per inch	Pack quantity	Min. order quantity	Article Number	EAN Code
5 - 8	1.8	14	3	1	48390519	045242201594
4 - 5	1.4	18	3	1	48390529	045242201747
≤ 4	1.0	25	3	1	48390539	045242201815



Bandsaw blade 685.80 x 12.7 x 0.51 mm (M12)

Material wall thickness (mm)	Tooth pitch (mm)	Teeth per inch	Pack quantity	Min. order quantity	Article Number	EAN Code
2.5 - 8	1.4	18	3	1	48390572	045242272341



DIAMOND BLADES

3 PERFORMANCE LEVELS



PREMIUM SPEEDCROSS X

Best-in class diamond blade.

1 Product line, suitable for all kind of hard building materials.

Precise positioned and arranged diamond technology for consistently high cutting performance, superior cutting speed and longest life.



SPEEDCROSS

Premium diamond blades. Outstanding performance.

Distinct product lines to cover all applications and trades.

Selection of premium diamonds, bond, combined with state-of-the-art production processes, e.g., laser welded segments for maximum reliability.



CONTRACTOR

Diamond blades with excellent price to performance ratio.

Different product lines including versatile and multi-purpose blades to cover most professional user applications.

Segments made of high-grade diamonds, laser welded, or sintered directly to the steel body.

APPLICATION GUIDE

PERFORMANCE

MATERIAL

STONE

Natural Stone
Granite
Porphyry

CONCRETE

Reinforced

HARD MATERIALS

+ Aggregated
+ Brick / Clinker (hard)
+ Roof tiles (hard)
+ Paving blocks etc.

CONCRETE

Medium strength

ABRASIVE

Soft Concrete /
Green concrete
Brick / Clinker
(soft)
Screed, Lime
sandstone

ASPHALT

CERAMICS

Tiles

STEEL

Iron
Stainless steel
Non-ferrous
metals

CONTRACTOR

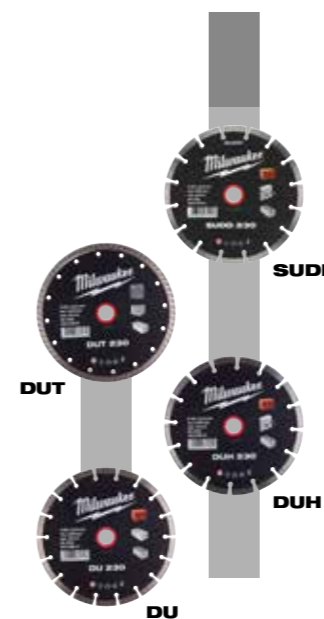

SPEEDCROSS



PREMIUM SPEEDCROSS



Premium Speedcross XHUDD

Best-in-class diamond blade.
Suitable for all kinds of hard building materials.
Consistently high cutting performance due to precise positioned and arranged diamonds.
Up to 15 mm segment height for longest life.
Laser welded short V-grooved tooth segments for extremely aggressive cutting and superior cutting speed and improved dust extraction.
Suitable for cutting: Hard building materials, granite, reinforced concrete, aggregate concrete, hard brick/clinker, roof tiles, block paving, porphyry, ...



Type	Disc diameter (mm)	Bore size (mm)	Segment height (mm)	Cutting width (mm)	Pack quantity	Min. order quantity	Article Number	EAN Code
XHUDD 115	115	22.23	12	2.6	1	1	4932492147	4058546415143
XHUDD 125	125	22.23	12	2.6	1	1	4932492148	4058546415150
XHUDD 150	150	22.23	12	2.6	1	1	4932492149	4058546415167
XHUDD 230	230	22.23	15	2.6	1	1	4932492150	4058546415174
XHUDD 350	350	25.4	14	2.6	1	1	4932492151	4058546415181

Speedcross SUDD

Significantly reduced noise level due to Silent Technology.
Universal application in all hard building materials.
15 mm segment height for longest life.
Segments with distinct pattern to reduce friction, heat build up, and for faster cutting.
Laser welded segments for maximum reliability.
Suitable for cutting: Hard building materials, granite, reinforced concrete, aggregate concrete, hard/medium brick/clinker, block paving, roof tiles, ...



Type	Disc diameter (mm)	Bore size (mm)	Segment height (mm)	Cutting width (mm)	Pack quantity	Min. order quantity	Article Number	EAN Code
SUDD 230	230	22.23	15	3.4	1	1	4932492152	4058546415198
SUDD 350	350	25.4	15	3.4	1	1	4932492153	4058546415204

Speedcross HUDD

Universal application in all hard to medium hard general building materials.
10 mm segment height with premium diamond-grade for longest life, laser welded for maximum reliability.
Steel core with special cooling hole pattern to reduce heat and minimise friction.
Suitable for cutting: Hard building materials, granite, reinforced concrete, aggregate concrete, hard/medium brick/clinker, block paving, roof tiles, ...



Type	Disc diameter (mm)	Bore size (mm)	Segment height (mm)	Cutting width (mm)	Pack quantity	Min. order quantity	Article Number	EAN Code
HUDD 115	115	22.23	10	2.6	1	1	4932399819	4002395364749
HUDD 125	125	22.23	10	2.6	1	1	4932399820	4002395364756
HUDD 150	150	22.23	10	2.6	1	1	4932399821	4002395364763
HUDD 230	230	22.23	10	2.6	1	1	4932399822	4002395364770
HUDD 300	300	25.4	10	2.6	1	1	4932493298	4058546481698
HUDD 350	350	25.4	8	2.6	1	1	4932471985	4058546298845

Speedcross AUDD

Universal application in all soft / abrasive to medium hard general building materials.
10 mm segment height with premium diamond-grade for longest life, laser welded for maximum reliability.
Steel core with special cooling hole pattern to reduce heat and minimize friction.
Suitable for cutting: Asphalt, soft clinker, green concrete, soft brick, screed, lime sandstone, ...



*For Speedcross AUDD 350mm only

Type	Disc diameter (mm)	Bore size (mm)	Segment height (mm)	Cutting width (mm)	Pack quantity	Min. order quantity	Article Number	EAN Code
AUDD 115	115	22.23	10	2.6	1	1	4932399823	4002395364787
AUDD 125	125	22.23	10	2.6	1	1	4932399824	4002395364794
AUDD 150	150	22.23	10	2.6	1	1	4932399825	4002395364800
AUDD 230	230	22.23	10	2.6	1	1	4932399826	4002395364817
AUDD 350*	350	25.4	10	2.6	1	1	4932471987	4002396298869
AUDD 450	450	25.4	10	2.6	1	1	4932492145	4058546415129

Speedcross STEELHEAD™

STEELHEAD™ is a specialist blade most suitable for steel, stainless steel and nonferrous metals. Extremely fast and aggressive cutting performance due to high density of vacuum brazed diamond coating. Consistent cutting depth, no risk of disc breakage and highest productivity vs. standard non-diamond cutting discs. Due to the versatility and the outstanding performance the diamond disc is also perfect for fire brigades and for rescue operations.



Type	Disc diameter (mm)	Bore size (mm)	Segment height (mm)	Cutting width (mm)	Pack quantity	Min. order quantity	Article Number	EAN Code
STEELHEAD™ 115	115	22.23	2	1.5	1	1	4932492014	4058546413811
STEELHEAD™ 125	125	22.23	2	1.5	1	1	4932492015	4058546413828
STEELHEAD™ 230	230	22.23	2	1.8	1	1	4932492016	4058546413835
STEELHEAD™ 350	350	25.4	4	2.8	1	1	4932471988	4058546298876

Speedcross DHMM

A brazed diamond disc designed for a wide range of applications. Outstanding cutting performance due to extremely high diamond concentration. Suitable for a vast variety of material like PVC, granite, tiles, hard artificial stone, composite material, drywall, thin wood, threaded rods and sheet metal.

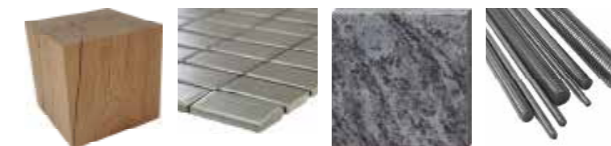

Type	Disc diameter (mm)	Bore size (mm)	Segment height (mm)	Cutting width (mm)	Pack quantity	Min. order quantity	Article Number	EAN Code
DHMM 76	76	10	2.2	1.2	1	1	4932471333	4058546289614

Speedcross DHTi

Premium turbo rimmed blade for hardest tiles (ceramics, gres, porcelain) up to 20 mm thickness. Extra fast, clean and precise cutting performance due to continuous turbo rimmed diamond segment. Reduced dust development. 10 mm segment height, high-grade diamonds and premium bond for longest life.



Type	Disc diameter (mm)	Bore size (mm)	Segment height (mm)	Cutting width (mm)	Pack quantity	Min. order quantity	Article Number	EAN Code
DHTi 115	115	22.23	10	2.3	1	1	4932492154	4058546415211
DHTi 125	125	22.23	10	2.3	1	1	4932492155	4058546415228
DHTi 230	230	22.23	10	2.3	1	1	4932492156	4058546415235

Speedcross ADD

Asphalt application dedicated diamond disc. Also suitable for green concrete and other highly abrasive materials. Double tensioned core for maximum durability and strength. Special angled segments to eliminate risk of segment breakage and reduce wear. 10 mm segment height with premium diamond-grade for longest life, laser welded for maximum reliability.



Type	Disc diameter (mm)	Bore size (mm)	Segment height (mm)	Cutting width (mm)	Pack quantity	Min. order quantity	Article Number	EAN Code
ADD 350 mm	350	25.4	10	2.8	1	1	4932478952	4058546362348

Contractor SUDD

A laser welded quality blade with excellent performance and universal application in medium to hard building materials. Significantly reduced noise level due to Silent Technology.

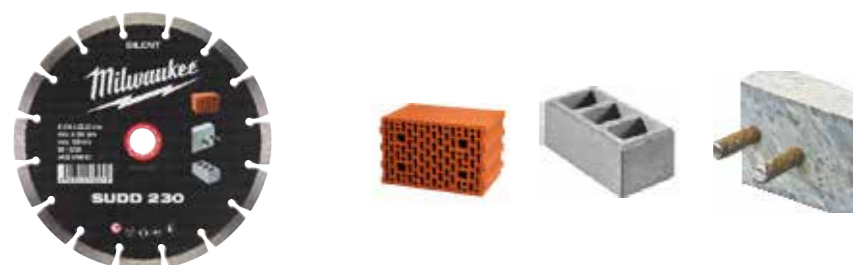

Type	Disc diameter (mm)	Bore size (mm)	Segment height (mm)	Cutting width (mm)	Pack quantity	Min. order quantity	Article Number	EAN Code
SUDD 230 mm	230	22.23	10	3.0	1	1	4932479463	4058546372576
SUDD 350 mm	350	25.4	10	3.1	1	1	4932479462	4058546372569

Contractor DUH

A laser welded quality blade with excellent performance and universal application in medium to hard building materials.



Type	Disc diameter (mm)	Bore size (mm)	Segment height (mm)	Cutting width (mm)	Pack quantity	Min. order quantity	Article Number	EAN Code
DUH 115	115	22.23	10	2.2	1	1	4932399539	4002395361861
DUH 125	125	22.23	10	2.3	1	1	4932399540	4002395361878
DUH 180	180	22.23	10	2.4	1	1	4932399541	4002395361885
DUH 230	230	22.23	10	2.6	1	1	4932399542	4002395361892
DUH 300	300	25.4	10	2.8	1	1	4932493331	4058546482022
DUH 350	350	25.4	10	2.8	1	1	4932471986	4058546298852
DUH 400	400	25.4	10	3.2	1	1	4932492146	4058546415136

Contractor DSU

A special blade recommended for use with wall chasers. A laser welded quality blade with excellent performance and universal application in hard and abrasive materials. Ø 125 mm for WCE 30; Ø 150 mm for WCS 45.



Type	Disc diameter (mm)	Bore size (mm)	Segment height (mm)	Cutting width (mm)	Pack quantity	Min. order quantity	Article Number	EAN Code
DSU 125	125	22.23	10	2.4	1	1	4932373147	4002395346455
DSU 150	150	22.23	10	2.4	1	1	4932373148	4002395346462

Contractor DU

A general-purpose blade for a wide range of building materials with excellent price to performance ratio and direct sintered segments.



Type	Disc diameter (mm)	Bore size (mm)	Segment height (mm)	Cutting width (mm)	Pack quantity	Min. order quantity	Article Number	EAN Code
DU 115	115	22.23	10	2.2	1	1	4932399521	4002395361687
DU 125	125	22.23	10	2.3	1	1	4932399522	4002395361694
DU 180	180	22.23	10	2.4	1	1	4932399523	4002395361700
DU 230	230	22.23	10	2.6	1	1	4932399524	4002395361717
DU 300	300	25.4	10	2.3	1	1	4932493332	4058546482039

Contractor DHTi

Tile blade with excellent price to performance ratio. Clean cuts in all kinds of soft and hard tiles.

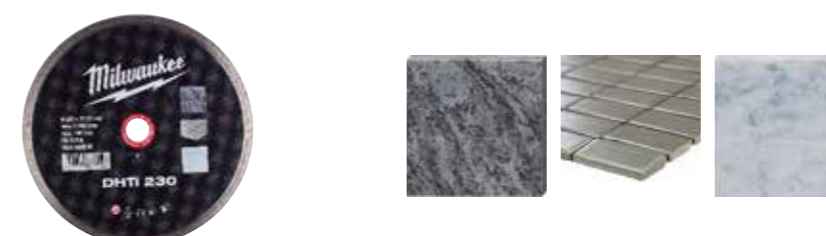

Type	Disc diameter (mm)	Bore size (mm)	Segment height (mm)	Cutting width (mm)	Pack quantity	Min. order quantity	Article Number	EAN Code
DHTi 115	115	22.23	8	2.0	1	1	4932399552	4002395361991
DHTi 125	125	22.23	8	2.1	1	1	4932399553	4002395362004
DHTi 230	230	22.23	8	2.6	1	1	4932399555	4002395362028

Contractor DUT

A general-purpose blade for a wide range of building materials up to medium hardness, natural and artificial stone with excellent price to performance ratio.
Extra clean cuts due to closed turbo rim.



Type	Disc diameter (mm)	Bore size (mm)	Segment height (mm)	Cutting width (mm)	Pack quantity	Min. order quantity	Article Number	EAN Code
DUT 115	115	22.23	10	2.2	1	1	4932399526	4002395361731
DUT 125	125	22.23	10	2.3	1	1	4932399527	4002395361748
DUT 180	180	22.23	10	2.4	1	1	4932399528	4002395361755
DUT 230	230	22.23	10	2.6	1	1	4932399529	4002395361762

Contractor DHTS

Turbo blade with extra thin body for very fast and precise cuts in soft and hard tiles, fine stoneware, as well as natural and artificial stones.
Extra clean cuts. Less dust development.

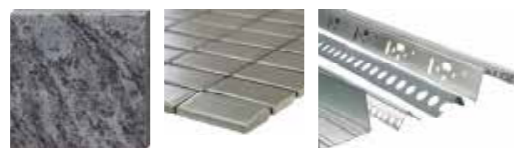

Type	Disc diameter (mm)	Bore size (mm)	Segment height (mm)	Cutting width (mm)	Pack quantity	Min. order quantity	Article Number	EAN Code
DHTS 76	76	10	5	1	1	1	4932464715	4058546226602
DHTS 115	115	22.23	10	1.2	1	1	4932399145	4002395357550
DHTS 125	125	22.23	10	1.2	1	1	4932399146	4002395357567
DHTS 230	230	22.23	10	1.9	1	1	4932399550	4002395361977

Sharpening Stones

Special corundum mixture bond for sharpening diamond cutting blades and diamond core drills.
High sharpening speed without damaging the grain.



Description	Length (mm)	Width (mm)	Pack quantity	Min. order quantity	Article Number	EAN Code
Sharpening stone large	300	160	1	1	4932492362	4058546417291
Sharpening stone small	200	50	1	1	4932492361	4058546417284

Combi-segment diamond cup wheels

For quick grinding down of thick concrete layers, abrasive materials or special substances.
For levelling of concrete, granite and natural stone surfaces.
For edge grinding applications e.g. grinding off high edges of concrete, granite, natural stone tiles.
For roughening prior to covering with a new layer of coating.
High quality diamonds and special soft bonding for low wear, especially in hard materials.

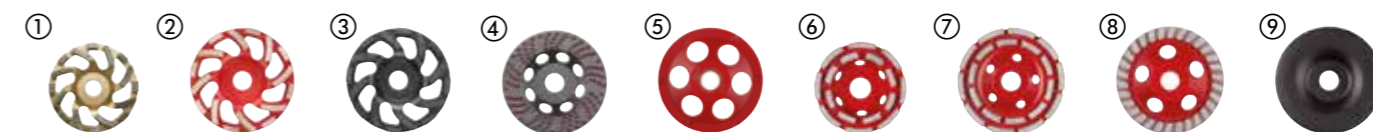

Type	Diameter (mm)	Bore size (mm)	No. of segments	Cup wheel height [mm]	Segment height (mm)	Pack quantity	Min. order quantity	Article Number	EAN Code
SDCWU 100									
① Premium universal wheel for grinding and levelling applications. Highest stock removal.	100	22.23	16	21	5	1	1	4932430080	4002395377411
SDCWU 125									
② Premium universal wheel for grinding and levelling applications. Highest stock removal.	125	22.23	16	21	5	1	1	4932430081	4002395377428
SDCWA 125									
③ Universal wheel for grinding and levelling applications. High stock removal. For abrasive materials.	125	22.23	16	21	5	1	1	4932479093	4058546368876
Fine SDCWSF 125									
④ Premium wheel with fine diamond pads for removal of special substances: thermoplastics and epoxy based coatings, acrylic paint, glue, tile adhesive, screed, plaster.	125	22.23	Diamond Pads	21	3.3	1	1	4932479094	4058546368883
Coarse SDCWSC 125									
⑤ PCD segment for removal of special substances: thermoplastic and epoxy based coatings, acrylic paint, glue, tile adhesive, screed, plaster	125	22.23	6	18.5	4 / 7	1	1	4932451188	4002395138760
DCWU 100									
⑥ Universal wheel for grinding and levelling applications. High stock removal	100	22.23	16	21	5	1	1	4932451185	4002395138739
DCWU 125									
⑦ Universal wheel for grinding and levelling applications. High stock removal	125	22.23	20	21	5	1	1	4932451186	4002395138746
DCWUT 125									
⑧ Turbo type segment for levelling, edge grinding and for smooth finishing. Fine finish for concrete and natural stone	125	22.23	Turbo	21	5	1	1	4932451187	4002395138753
SDCWUG 125									
⑨ Premium universal diamond grinding wheel for: hard artificial stone, porcelain tiles, ceramics, granite, marble, wood, hard plastics, steel.	125	22.23	-	13.3	-	1	1	4932480219	4058546405045

	SDCWU	SDCWA	Fine SDCWSF	Coarse SDCWSC	DCWU	DCWUT	SDCWUG
Acrylic paint and coatings			✓	✓			
Aerated and breeze concrete blocks	✓	✓			✓	✓	
Bitumen			✓	✓			
Concrete hard	✓	♦			✓	✓	♦
Concrete soft or green	♦	✓			♦	♦	
Epoxy resin coatings and glues							
Granite	♦				♦	♦	✓
Lime and sandstone blocks hard	✓	♦			✓	✓	
Lime and sandstone blocks soft and abrasive	♦	✓			♦	♦	
Marble	♦	♦			♦	♦	✓
Plasterboard	♦	✓			♦	♦	
Porphyry	♦	♦			♦	♦	✓
Screed	♦	✓	✓	✓		♦	
Thermoplastic protective paint, glue			✓	✓			
Tile adhesive	♦	✓			♦	♦	

✓ Most suitable.
♦ Suitable - for intermittent use.

Cutting and grinding discs

MILWAUKEE® Type - how to find the right disc

SC 41 / 115			
Material	Application	Design	Diameter
S = Steel C = Stone	C = Cutting G = Grinding CS = Cutting Slim L = Flap LC = Flap Ceramic CT = Cutting Thin	flat 41 depressed 42 depressed 27 flap 50	mm inches 100 4 115 4½ 125 5 150 6 180 7 230 9 350 14



Extended life and moisture protection with PRO+**

Special mixture delivers:

Up to 20% longer lifetime vs. MILWAUKEE® contractor series.
Up to 20% less dust development vs. MILWAUKEE® contractor series.
The new formula HydroProtect prevents the age-related loss of performance and still provides almost the entire performance after months of storage.

Benefits:

Reduced costs per cut and shorter set up times.
Reduction of wheel deterioration during the storage interval.
Longer lasting high-performance.

**available on cutting and grinding discs with thickness 1, 1.5, 1.9 and 6 mm.



Thin metal cutting discs PRO+

Applications: Most suitable for stainless and acid-resistant steel, hardox, heat-resistant cast steel, spring steel, mild and tool steel.

Characteristics: Pro+ technology for best lifetime: Hydro-protected against moisture for longer lasting power. Greater performance and longer runtime than the 1 mm pro+ and therefore cordless optimised. Lower material loss, less sparks. Made in Germany.



Type	Disc diameter (mm)	Thickness (mm)	Bore size (mm)	Pack quantity	Min. order quantity	Article Number	EAN Code
41 SCS 41 / 76	76	1	10	5	1	4932464717	4058546226626
SCS 41 / 115	115	1	22.2	1	50	4932451484	4002395163953
① Counter display (200 x SCS 41 / 115 discs)				200	1	4932451485	4002395163960
SCS 41 / 115	115	1.5	22.2	1	50	4932451486	4002395163977
SCS 42 / 125	125	0.8	22.2	1	50	4932498201	4058546520700
SCS 41 / 125	125	1	22.2	1	50	4932451487	4002395163984
① Counter display (200 x SCS 41 / 125 discs)				200	1	4932451488	4002395163991
Suitcase (600pc) (600 x SCS 41/125 discs)				600	1	4932500580	4058546618827
SCS 41 / 125	125	1.5	22.2	1	50	4932498002	4058546511623
SCS 41 / 150	150	1.5	22.2	1	25	4932471386	4058546290146
SCS 41 / 180	180	1.5	22.2	1	25	4932451489	4002395161300
SCS 41 / 230	230	1.9	22.2	1	25	4932451490	4002395161317
SCS 41 / 350	350	4	25.4	1	10	4932471989	4058546298883
② SCS 41 / 115	115	1	22.2	10	1	4932478997	4058546362799
③ SCS 41 / 125	125	1	22.2	10	1	4932478998	4058546362805

*Orders are only possible in master cartons. Order quantities greater than the pack quantity are to be ordered in multiples (i.e. 50, 100, 150...)

Metal cutting discs PRO+

Applications: Great performance in cutting mild steel with medium strength, plain alloy tool steel, concrete reinforcing iron and steel rebar.
Characteristics: Efficient cutting properties in combination with high performance.

Type	Disc diameter (mm)	Thickness (mm)	Bore size (mm)	Pack quantity	Min. order quantity	Article Number	EAN Code
41 SC 41 / 115	115	3	22.2	1	25	4932451491	4002395161324
SC 41 / 125	125	3	22.2	1	25	4932451492	4002395161331
SC 41 / 180	180	3	22.2	1	25	4932451493	4002395161348
SC 41 / 230	230	3	22.2	1	25	4932451494	4002395161362
42 SC 42 / 115	115	3	22.2	1	25	4932451495	4002395161379
SC 42 / 125	125	3	22.2	1	25	4932451496	4002395161393
SC 42 / 180	180	3	22.2	1	25	4932451497	4002395162000
SC 42 / 230	230	3	22.2	1	25	4932451498	4002395162017

*Orders are only possible in master cartons. Order quantities greater than the pack quantity are to be ordered in multiples (i.e. 50, 100, 150...)

Metal cutting discs for chop saws PRO+

Applications: For structural steels, tool steel, cast iron, hard high-grade steels and concrete reinforcing steel bars (rebar).
Characteristics: Soft cutting wheel for chop saws.

Type	Disc diameter (mm)	Thickness (mm)	Bore size (mm)	Pack quantity	Min. order quantity	Article Number	EAN Code
41 SC 41 / 355	355	2.5	25.4	1	10	4932451505	4002395162086

*Orders are only possible in master cartons. Order quantities greater than the pack quantity are to be ordered in multiples (i.e. 50, 100, 150...)

Metal grinding discs PRO+

Applications: Sound performance in mild steel and non alloy tool steel.
Characteristics: Provides good lifetime and efficient grinding characteristics.

Type	Disc diameter (mm)	Thickness (mm)	Bore size (mm)	Pack quantity	Min. order quantity	Article Number	EAN Code
27 SG 27 / 115	115	6	22.2	1	25	4932451501	4002395162048
SG 27 / 125	125	6	22.2	1	25	4932451502	4002395162055
SG 27 / 150	150	6	22.2	1	10	4932471387	4058546290153
SG 27 / 180	180	6	22.2	1	10	4932451503	4002395162062
SG 27 / 230	230	6	22.2	1	10	4932451504	4002395162079

*Orders are only possible in master cartons. Order quantities greater than the pack quantity are to be ordered in multiples (i.e. 50, 100, 150...)

Stone cutting discs PRO+

Applications: for concrete, masonry products and thin natural stone tiles.

Type	Diameter (mm)	Thickness (mm)	Bore size (mm)	Pack quantity	Min. order quantity	Article Number	EAN Code
42 CC 42 / 115	115	3	22.2	1	25	4932451499	4002395162024
CC 42 / 230	230	3	22.2	1	25	4932451500	4002395162031

*Orders are only possible in master cartons. Order quantities greater than the pack quantity are to be ordered in multiples (i.e. 50, 100, 150...)

Thin ductile iron, stone and multi material disc

Applications: Ductile iron, non-ferrous metals & stone.

* Minimum order quantity = 10 pcs. Orders > 10 pcs must be ordered in multiples of 10 (i.e. 10, 20, 30, 40)



Type	Disc diameter (mm)	Thickness (mm)	Bore size (mm)	Pack quantity	Min. order quantity	Article Number	EAN Code
CCS 41 / 350	350	4	25.4	1	10	4932472264	4058546339104

Thin metal cutting discs - contractor series

Applications: Iron and sulphur free thin cut-off wheels for steel.

Suitable for acid-resistant steel, hardox, high-alloy steel, mild and tool steel.

Not suitable for stainless steel.



Type	Diameter (mm)	Thickness (mm)	Bore size (mm)	Pack quantity	Min. order quantity	Article Number	EAN Code
41 SCS 41 / 115	115	1	22.2	1	50	4932451474	4002395163250
① Counter display (200 x SCS 41 / 115 discs)				200	1	4932451475	4002395163267
SCS 41 / 115	115	1.5	22.2	1	50	4932451476	4002395163274
SCS 41 / 125	125	1	22.2	1	50	4932451477	4002395163281
① Counter display (200 x SCS 41 / 125 discs)				200	1	4932451478	4002395163298
SCS 41 / 125	125	1.5	22.2	1	50	4932451479	4002395163908
SCS 41 / 230	230	1.9	22.2	1	25	4932451480	4002395163915
② SCS 41 / 125	125	1	22.2	10	1	4932459164	4002395287192

*Orders are only possible in master cartons. Order quantities greater than the pack quantity are to be ordered in multiples (i.e. 50, 100, 150...)

Metal grinding discs - contractor series

Applications: suitable for mild steel. Not suitable for stainless steel.

Type	Diameter (mm)	Thickness (mm)	Bore size (mm)	Pack quantity	Min. order quantity	Article Number	EAN Code
27 SG 27 / 115	115	6	22.2	1	25	4932451481	4002395163922
SG 27 / 125	125	6	22.2	1	25	4932451482	4002395163939
SG 27 / 230	230	6	22.2	1	10	4932451483	4002395163946

*Orders are only possible in master cartons. Order quantities greater than the pack quantity are to be ordered in multiples (i.e. 50, 100, 150...)

Carbide Blade

Carbide blade suitable for cutting wood, plastic and plasterboard.

No risk of disc breakages.

Cutting depth remains the same over the lifetime of the disc.

Suitable for cutting all types of softer materials.

Suitable for use with angle grinders.



Diameter (mm)	Thickness (mm)	Bore size (mm)	Pack quantity	Min. order quantity	Article Number	EAN Code
76	1	10	1	1	4932464716	4058546226619
115	1	22.23	1	1	4932492376	4058546417437
125	1	22.23	1	1	4932492377	4058546417444

Flap discs CERA TURBO™

Maximum productivity with CERA TURBO™, 50% faster material removal and 2x longer lifetime vs. bonded disc.

Ceramic hybrid disc: grinds steel, stainless steel.

Plastic backing pad.

Highly flexible: perfectly adjusts to working piece.

Low heat development: no metal discolouration, especially on stainless steel.

Made in Germany.

Best for ferrous metals, stainless steel V2A (1.4301) / V4A (1.4401) and non-ferrous metals (aluminium, titan, etc.).

Orders must be in multiples of 10 pcs.



Type	Disc diameter (mm)	Grit	Bore size (mm)	Backing pad material	Pack quantity	Min. order quantity	Article Number	EAN Code
50 SLC 50 / 115	115	40	22.2	Plastic	1	10	4932472228	4058546326241
SLC 50 / 115	115	60	22.2	Plastic	1	10	4932472229	4058546326258
SLC 50 / 115	115	80	22.2	Plastic	1	10	4932472230	4058546326265
SLC 50 / 125	125	40	22.2	Plastic	1	10	4932472231	4058546326272
SLC 50 / 125	125	60	22.2	Plastic	1	10	4932472232	4058546326289
SLC 50 / 125	125	80	22.2	Plastic	1	10	4932472233	4058546326296

Flap discs CERA TURBO™ XL

Maximum productivity with CERA TURBO™, 50% faster material removal and 2x longer lifetime vs. bonded disc.

CERA TURBO™ XL with 10 mm protruding flaps for grinding down fillet welds.

Ceramic hybrid disc: grinds steel, stainless steel.

Natural fibre backing pad.

Highly flexible: perfectly adjusts to working piece.

Low heat development: no metal discolouration, especially on stainless steel.

Best for ferrous metals, stainless steel V2A (1.4301) / V4A (1.4401) and non-ferrous metals (aluminium, titan, etc.).

Orders must be in multiples of 10 pcs.

Made in Germany.



Type	Disc diameter (mm)	Grit	Bore size (mm)	Backing pad material	Pack quantity	Min. order quantity	Article Number	EAN Code
SLC XL 50 / 115	115	40	22.2	Plastic	1	10	4932478946	4058546362287
SLC XL 50 / 115	115	60	22.2	Plastic	1	10	4932478947	4058546362294
SLC XL 50 / 115	115	80	22.2	Plastic	1	10	4932478948	4058546362300
SLC XL 50 / 125	125	40	22.2	Plastic	1	10	4932478949	4058546362317
SLC XL 50 / 125	125	60	22.2	Plastic	1	10	4932478950	4058546362324
SLC XL 50 / 125	125	80	22.2	Plastic	1	10	4932478951	4058546362331

Flap discs Zirconium

High quality zirconium grain: longer lifetime on ferrous metals and stainless steel.
Suitable for ferrous metals, stainless steel V2A (1.4301) / V4A (1.4401).
Natural fibre backing pad: low vibration & noise, no harmful dust.
Highly flexible: perfectly adjusts to working piece.
Made in Germany.

Orders must be in multiples of 10 pcs.



Type	Disc diameter (mm)	Grit	Bore size (mm)	Backing pad material	Pack quantity	Min. order quantity	Article Number	EAN Code	
50	SL 50 / 115	115	40	22.2	Plastic	1	10	4932472220	4058546326166
	SL 50 / 115	115	60	22.2	Plastic	1	10	4932472221	4058546326173
	SL 50 / 115	115	80	22.2	Plastic	1	10	4932472222	4058546326180
	SL 50 / 115	115	120	22.2	Plastic	1	10	4932472223	4058546326197
	SL 50 / 125	125	40	22.2	Plastic	1	10	4932472224	4058546326203
	SL 50 / 125	125	60	22.2	Plastic	1	10	4932472225	4058546326210
	SL 50 / 125	125	80	22.2	Plastic	1	10	4932472226	4058546326227
	SL 50 / 125	125	120	22.2	Plastic	1	10	4932472227	4058546326234

Flap discs Aluminium

Best for aluminium, non-ferrous metals and wood.
Special coating of the flaps prevent clogging of the disc whilst grinding aluminium, non-ferrous metals and wood.

Self trimming backing pad: allows grinding to the last grain.

Made in Germany.

Orders must be multiples of 10 pcs.



Type	Disc diameter (mm)	Grit	Bore size (mm)	Backing pad material	Pack quantity	Min. order quantity	Article Number	EAN Code
ALU SLC 50 / 115	115	40	22.2	Plastic	1	10	4932479089	4058546368838
ALU SLC 50 / 115	115	60	22.2	Plastic	1	10	4932479090	4058546368845
ALU SLC 50 / 125	125	40	22.2	Plastic	1	10	4932479091	4058546368852
ALU SLC 50 / 125	125	60	22.2	Plastic	1	10	4932479092	4058546368869

Metal Fiber Disc Zirconium

High stock removal rate.

Used for coarse grinding and deburring of steel and stainless steel.

High and even cutting performance with medium pressure.

Zirconium grain with self-sharpening effect.

Sizes available: 115mm, 125mm.

Grits available: G24, G40, G60, G80, G120.



Description	Disc diameter (mm)	Grit	Bore size (mm)	Pack quantity	Min. order quantity	Article Number	EAN Code
Metal Fiber Disc 115 G24	115	24	22	25	1	4932500212	4058546615147
Metal Fiber Disc 115 G40	115	40	22	25	1	4932500213	4058546615154
Metal Fiber Disc 115 G60	115	60	22	25	1	4932500214	4058546615161
Metal Fiber Disc 115 G80	115	80	22	25	1	4932500215	4058546615178
Metal Fiber Disc 115 G120	115	120	22	25	1	4932500217	4058546615192
Metal Fiber Disc 125 G24	125	24	22	25	1	4932500218	4058546615208
Metal Fiber Disc 125 G40	125	40	22	25	1	4932500220	4058546615222
Metal Fiber Disc 125 G60	125	60	22	25	1	4932500223	4058546615253
Metal Fiber Disc 125 G80	125	80	22	25	1	4932500219	4058546615215
Metal Fiber Disc 125 G120	125	120	22	25	1	4932500221	4058546615239

System attachments - angle grinders

Flexible backing pads

Requires flange nut M14 for all angle grinder - reference 4932345627.

Bore size (mm)	Diameter (mm)	Fits 115 mm angle grinders	Fits 125 mm angle grinders	Fits 180mm angle grinders	Fits 230mm angle grinders	Pack quantity	Min. order quantity	Article Number	EAN Code
14.2	110	✓				1	1	4932345760	4002395313488
14.2	125		✓			1	1	4932345761	4002395313495
14.2	170			✓		1	1	4932345758	4002395313501
22.2	170			✓		1	1	4932352744	4002395374021
Flange nut M14		✓	✓	✓	✓	1	1	4932345627	4002395313112



Fixtec Nut M14 universal



UNIVERSAL fitting to all angle grinders from Ø115 - 230mm.

Suitable for grinders with automatic / rapid braking systems.

Tool free disc changing in 12 seconds – NO tools required.

Only 8mm thick: allowing for more disc surface and for improved use in restricted areas.

Integrated keyholes for removing the nut with a standard spanner in case of over tightening during operation.



Description	Diameter (mm)	Thickness (mm)	Fits 115 mm angle grinders	Fits 125 mm angle grinders	Fits 180mm angle grinders	Fits 230mm angle grinders	Pack quantity	Min. order quantity	Article Number	EAN Code
Fixtec Nut M14 universal	45	8	✓	✓	✓	✓	1	1	4932498607	4058546524760



Carbide Burrs

According to DIN 8033.

Double cut tothing geometry ensures excellent material removal, low vibrations for easier handling and smaller swarfs.

Suitable for unhardened and hardened steel, cast iron and non ferrous metals (aluminium, brass, copper).

Includes: Types B, C, D, H, M.

Type B: End cut cylinder for top and side cutting.

Type C: Cylindrical ball nose for top and side cutting.

Type D: Ball for milling holes and creating concave cuts.

Type H: Flame for contouring.

Type M: Cone for angled edges and narrow contours.

Type of material	Cutting Speed m/min.	R.P.M. Ø 10mm	R.P.M. Ø 12,7mm
Steel, Hardness / Tensile strength < 1200 N/mm ²	200 - 400	8.000 - 12.000	7.000 - 10.000
Stainless Steel	200 - 350	8.000 - 12.000	7.000 - 10.000
Non Ferrous Metals	400 - 800	13.000 - 20.000	11.000 - 18.000
Cast iron	600 - 800	18.000 - 21.000	12.000 - 19.000
Fibre reinforced plastics	500 - 900	16.000 - 28.000	10.000 - 18.000

Type	Shank diameter (mm)	Width (mm)	Pack quantity	Min. order quantity	Article Number	EAN Code
B	6	10	1	1	4932493981	4058546511418
		12.7			4932493986	4058546511463
C	6	10	1	1	4932493982	4058546511425
		12.7			4932493987	4058546511470
D	6	10	1	1	4932493983	4058546511432
		12.7			4932493988	4058546511487
H	6	10	1	1	4932493984	4058546511449
		12.7			4932493989	4058546511494
M	6	10	1	1	4932493985	4058546511456
		12.7			4932493990	4058546511500
Burrs TC 6 x 10mm set - 5 pc	6	10	5	1	4932493577	4058546484484
Burrs TC 6 x 12.7mm set - 5 pc	6	12.7	5	1	4932493576	4058546484477



COATED ABRASIVES

3 PERFORMANCE LEVELS

STANDARD

- ALUMINIUM OXIDE (ALOX) GRAIN
- HEAVY PAPER, ROBUST AND TEAR RESISTANT
- SEMI-OPEN GRAIN DISTRIBUTION

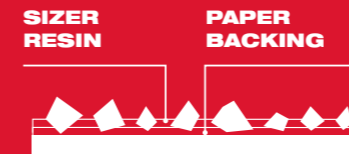

HIGH PERFORMANCE

- ALUMINIUM OXIDE (ALOX) GRAIN
- LIGHT AND MORE FLEXIBLE PAPER BACKING
- SEMI-OPEN GRAIN DISTRIBUTION
- BETTER SURFACE FINISH
- BETTER MATERIAL REMOVAL
- 2X LONGER LIVE VS. STANDARD
- STEARATE COATING TO PREVENT CLOGGING



POWERGRID MESH

- OPEN MESH
- ALUMINIUM OXIDE (ALOX) GRAIN
- OPEN GRAIN DISTRIBUTION
- NO CLOGGING FOR 3X LONGER LIFE VS STANDARD, CLEANABLE & REUSABLE
- BEST MATERIAL REMOVAL
- BEST SURFACE FINISH
- BEST OVERALL LIFETIME
- 99% DUSTFREE
- NO ALIGNMENT TO HOLE PATTERN



WHY USE A PAD SAVER WITH POWERGRID MESH?

PowerGrid Mesh is very aggressive, dust could wear and damage the Velcro on the backing pad.

Pad savers are the solution to extend life of the machines backing pad.

APPLICATIONS



STANDARD



✓	✓	✓	✓	✗	✗	✗	✗	✗
---	---	---	---	---	---	---	---	---

HIGH PERFORMANCE



✓	✓	✗	✓	✓	✓	✓	✓	✓
---	---	---	---	---	---	---	---	---

POWERGRID MESH



✓	✓	✓	✓	✓	✓	✓	✓	✗
---	---	---	---	---	---	---	---	---

HL = Hook & Loop

Sanding sheets for random orbital sanders

Power Grid Mesh Sanding Discs HL

NEW

Open mesh backing with aluminium oxide open grain for best material removal performance and fine finishing.
 Mesh structure provide for 99% dust free sanding and no clogging. Reduced clogging and dust build-up on work surface leads to best life and better finish.
 No designated hole pattern for quick dust hole alignment and compatible with all competitor backing pads.
 Easy to clean and re-use (wash or blow clean).
 3x longer life versus standard sandpaper.
 Suitable for all types of metal, wood, paint, plaster, filler and laquer.
 Recommended to be used with a pad saver.
 Power Grid Mesh Sanding Sheets 125 mm are suitable for M18 BOS125 and ROS 125 E.
 Power Grid Mesh Sanding Sheets 76 mm are suitable for M12 FSDR75.

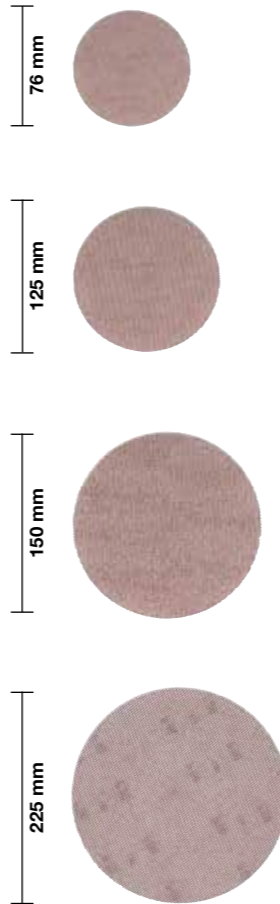

Grit	Paper size diameter (mm)	Pack quantity	Min. order quantity	Article Number	EAN Code
80	76	10	1	4932499368	4058546565329
120	76	10	1	4932499369	4058546565336
180	76	10	1	4932499370	4058546565343
240	76	10	1	4932499371	4058546565350
320	76	10	1	4932499372	4058546565367
400	76	10	1	4932499373	4058546565374
80	125	10	1	4932492185	4058546415525
120	125	10	1	4932492186	4058546415532
180	125	10	1	4932492187	4058546415549
240	125	10	1	4932492188	4058546415556
320	125	10	1	4932492189	4058546415563
400	125	10	1	4932492190	4058546415570
80	125	50	1	4932492203	4058546415709
120	125	50	1	4932492204	4058546415716
180	125	50	1	4932492205	4058546415723
240	125	50	1	4932492206	4058546415730
80	150	10	1	4932492220	4058546415877
120	150	10	1	4932492221	4058546415884
180	150	10	1	4932492222	4058546415891
240	150	10	1	4932492223	4058546415907
320	150	10	1	4932492224	4058546415914
400	150	10	1	4932492225	4058546415921
80	150	50	1	4932492238	4058546416058
120	150	50	1	4932492239	4058546416065
180	150	50	1	4932492240	4058546416072
240	150	50	1	4932492241	4058546416089
80	225	10	1	4932500187	4058546614898
120	225	10	1	4932500188	4058546614904
180	225	10	1	4932500189	4058546614911
240	225	10	1	4932500190	4058546614928
320	225	10	1	4932500191	4058546614935

Mesh Pad Saver 76 mm HL Set - 10 pcs	10	1	4932499374	4058546565381
Sand Disc PG Mesh: 3 x Grit 80 / 3 x Grit 120 / 3 x Grit 180, 1 x Pad Saver				
Mesh & Pad Saver 125 mm H&L Set 1 - 10 pcs	10	1	4932492293	4058546416607
Sand Disc PG Mesh: 3 x Grit 80 / 3 x Grit 120 / 3 x Grit 180, 1 x Pad Saver				
Mesh & Pad Saver 150 mm H&L Set 2 - 10 pcs	10	1	4932492294	4058546416614
Sand Disc PG Mesh: 3 x Grit 80 / 3 x Grit 120 / 3 x Grit 180, 1 x Pad Saver				
PG 225 HL G80 120 180 Pad Saver Set - 10 pc	10	1	4932500192	4058546614942
Sand Disc PG Mesh: 3 x Grit 80 / 3 x Grit 120 / 3 x Grit 180, 1 x Pad Saver				



High Performance Sanding Discs HL

NEW

Grit	Paper size diameter (mm)	Pack quantity	Min. order quantity	Article Number	EAN Code
40	125	10	1	4932492178	4058546415457
60	125	10	1	4932492179	4058546415464
80	125	10	1	4932492180	4058546415471
120	125	10	1	4932492181	4058546415488
180	125	10	1	4932492182	4058546415495
240	125	10	1	4932492183	4058546415501
320	125	10	1	4932492184	4058546415518
40	125	50	1	4932492197	4058546415648
60	125	50	1	4932492198	4058546415655
80	125	50	1	4932492199	4058546415662
120	125	50	1	4932492200	4058546415679
180	125	50	1	4932492201	4058546415686
240	125	50	1	4932492202	4058546415693
40	150	10	1	4932492213	4058546415808
60	150	10	1	4932492214	4058546415815
80	150	10	1	4932492215	4058546415822
120	150	10	1	4932492216	4058546415839
180	150	10	1	4932492217	4058546415846
240	150	10	1	4932492218	4058546415853
320	150	10	1	4932492219	4058546415860
40	150	50	1	4932492232	4058546415990
60	150	50	1	4932492233	4058546416003
80	150	50	1	4932492234	4058546416010
120	150	50	1	4932492235	4058546416027
180	150	50	1	4932492236	4058546416034
240	150	50	1	4932492237	4058546416041
150	150	50	1	4932499979	4058546571436
220	150	50	1	4932499981	4058546571450
280	150	50	1	4932499983	4058546571474
320	150	50	1	4932499984	4058546571481
400	150	50	1	4932499985	4058546571498
500	150	50	1	4932499986	4058546571504
600	150	50	1	4932499987	4058546571511
800	150	50	1	4932499988	4058546571528

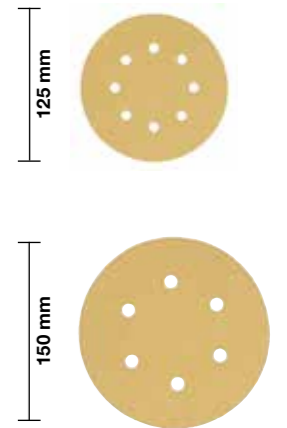

Standard Sanding Discs HL

Grit	Paper size diameter (mm)	Pack quantity	Min. order quantity	Article Number	EAN Code
40	125	10	1	4932492172	4058546415396
60	125	10	1	4932492173	4058546415402
80	125	10	1	4932492174	4058546415419
120	125	10	1	4932492175	4058546415426
180	125	10	1	4932492176	4058546415433
240	125	10	1	4932492177	4058546415440
40	125	50	1	4932492191	4058546415587
60	125	50	1	4932492192	4058546415594
80	125	50	1	4932492193	4058546415600
120	125	50	1	4932492194	4058546415617
180	125	50	1	4932492195	4058546415624
240	125	50	1	4932492196	4058546415631
40	150	10	1	4932492207	4058546415747
60	150	10	1	4932492208	4058546415754
80	150	10	1	4932492209	4058546415761
120	150	10	1	4932492210	4058546415778
180	150	10	1	4932492211	4058546415785
240	150	10	1	4932492212	4058546415792
40	150	50	1	4932492226	4058546415938
60	150	50	1	4932492227	4058546415945
80	150	50	1	4932492228	4058546415952
120	150	50	1	4932492229	4058546415969
180	150	50	1	4932492230	4058546415976
240	150	50	1	4932492231	4058546415983

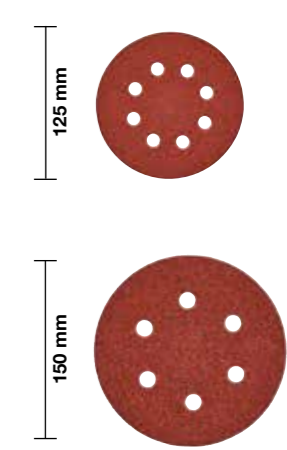

Standard Sanding Discs - no holes HL

NEW

Grit	Paper size diameter (mm)	Pack quantity	Min. order quantity	Article Number	EAN Code
40	150	50	1	4932498927	4058546527969
60	150	50	1	4932498928	4058546527976
80	150	50	1	4932498929	4058546527983
100	150	50	1	4932498930	4058546527990
120	150	50	1	4932498931	4058546528003

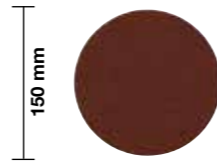

Pad Saver

NEW

For use with mesh type sanding papers.
Protects the backing pad from damage.
Pad Saver 125 mm is suitable for M18 BOS125 and ROS 125 E.

Diameter (mm)	Pack quantity	Min. order quantity	Article Number	EAN Code
76	5	1	4932501269	4058546639853
125	5	1	4932492291	4058546416584
150	5	1	4932492292	4058546416591
225	5	1	4932500193	4058546614959

Paper size diameter (mm)	Pack quantity	Min. order quantity	Article Number	EAN Code
93x93	5	1	4932500194	4058546614966
100x147	5	1	4932500186	4058546614881
115x107	5	1	4932500196	4058546614980

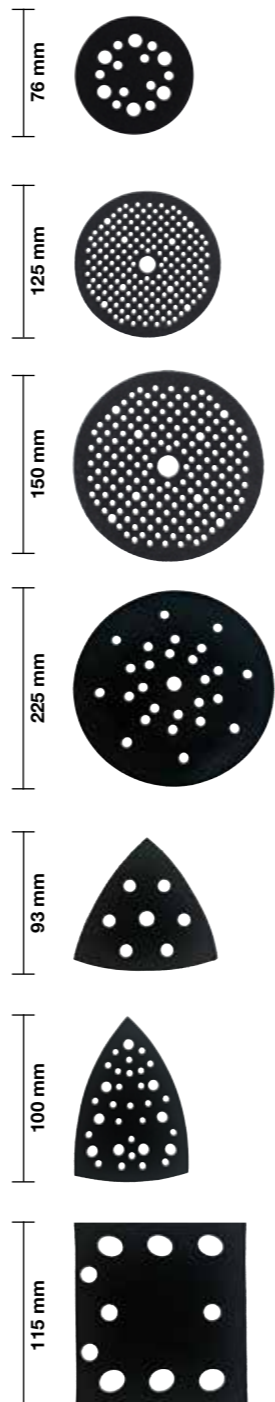

Power Grid Mesh Sanding Sheets HL

NEW

Grit	Paper size A x B (mm)	Pack quantity	Min. order quantity	Min. order quantity	Article Number	EAN Code
80	115 x 107	10	1	1	4932492249	4058546416164
120	115 x 107	10	1	1	4932492250	4058546416171
180	115 x 107	10	1	1	4932492251	4058546416188
240	115 x 107	10	1	1	4932492252	4058546416195
320	115 x 107	10	1	1	4932492253	4058546416201
400	115 x 107	10	1	1	4932492254	4058546416218

PG 115 x 107 HL G80 120 180
Pad Saver Set - 10 pc
Sand Disc PG Mesh: 3 x Grit 80 /
3 x Grit 120 / 3 x Grit 180,
1 x Pad Saver

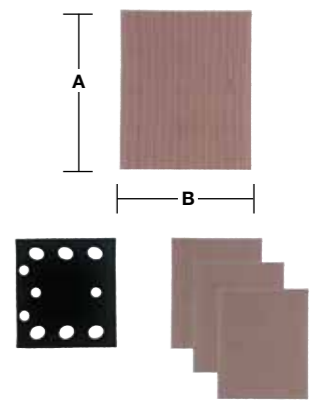

High Performance Sanding Sheets HL

NEW

Grit	Paper size A x B (mm)	Pack quantity	Min. order quantity	Article Number	EAN Code
80	115 x 107	10	1	4932492244	4058546416119
120	115 x 107	10	1	4932492245	4058546416126
180	115 x 107	10	1	4932492246	4058546416133
240	115 x 107	10	1	4932492247	4058546416140
320	115 x 107	10	1	4932492248	4058546416157

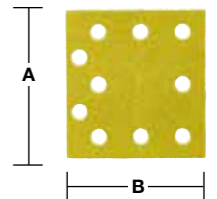

Standard Sanding Sheets HL

NEW

Grit	Paper size A x B (mm)	Pack quantity	Min. order quantity	Article Number	EAN Code
40	115 x 107	10	1	4932492242	4058546416096
60	115 x 107	10	1	4932492759	4058546476304
80	115 x 107	10	1	4932492760	4058546476311
120	115 x 107	10	1	4932492761	4058546476328
180	115 x 107	10	1	4932492243	4058546416102
240	115 x 107	10	1	4932492762	4058546476335

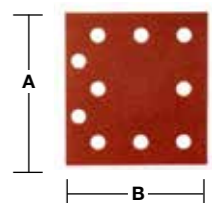

Standard Sanding Sheets HL

Grit	Paper size A x B (mm)	Pack quantity	Min. order quantity	Article Number	EAN Code
60	80 x 133	10	1	4932492763	4058546476342
80	80 x 133	10	1	4932492764	4058546476359
120	80 x 133	10	1	4932492765	4058546476366
180	80 x 133	10	1	4932492766	4058546476373
240	80 x 133	10	1	4932492767	4058546476380
40	93 x 185	10	1	4932492257	4058546416249
60	93 x 185	10	1	4932492258	4058546416256
80	93 x 185	10	1	4932492259	4058546416263
120	93 x 185	10	1	4932492260	4058546416270
180	93 x 185	10	1	4932492261	4058546416287
240	93 x 185	10	1	4932492262	4058546416294
40	115 x 230	10	1	4932492263	4058546416300
60	115 x 230	10	1	4932492264	4058546416317
80	115 x 230	10	1	4932492265	4058546416324
120	115 x 230	10	1	4932492266	4058546416331
180	115 x 230	10	1	4932492267	4058546416348
240	115 x 230	10	1	4932492268	4058546416355

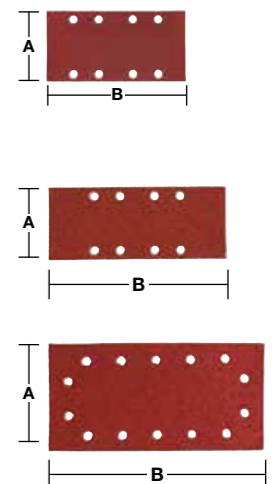

Power Grid Mesh Delta Sanding Sheets HL

12 x longer life compared to standard sandpaper.

Open mesh structure for almost dust-free sanding and longest life. The mesh structure increases performance and reduces clogging.

Mesh sheet 67 x 92 mm is suitable for Mesh Sheets for M12 FDSS.

Can be cleaned with compressed air, vacuumed or rinsed out with water.

Application: wood, painted wood, plastic, filler, drywall, metal, plaster, lacquer.

Each pack includes 1 pad saver. Always use a pad saver when using mesh type abrasives, this protects the tool backing pad from damage.

Grit options available: G80, G120, G180, G220, G320, G400.

Sponge Interface Pad available separately.



Grit	Paper size A x B (mm)	Pack quantity	Min. order quantity	Article Number	EAN Code
80	67 x 92	13	1	4932501318	4058546640347
120	67 x 92	13	1	4932501319	4058546640354
180	67 x 92	13	1	4932501320	4058546640361
220	67 x 92	13	1	4932501321	4058546640378
Sponge Interface Pad 67 x 92 mm	67 x 92	1	1	4932501322	4058546640385
Mesh 67 x 92 mm - 12 pc Set + Pad saver		13	1	4932501323	4058546640392

Sanding sheets for delta sanders

Power Grid Mesh Delta Sanding Sheets HL

NEW

Grit	Paper size A x B (mm)	Pack quantity	Min. order quantity	Article Number	EAN Code
80	93 x 93	10	1	4932492281	4058546416485
120	93 x 93	10	1	4932492282	4058546416492
180	93 x 93	10	1	4932492283	4058546416508
240	93 x 93	10	1	4932492284	4058546416515
80	100x147	10	1	4932500179	4058546614812
120	100x147	10	1	4932500180	4058546614829
180	100x147	10	1	4932500181	4058546614836
240	100x147	10	1	4932500182	4058546614843
320	100x147	10	1	4932500183	4058546614850
400	100x147	10	1	4932500184	4058546614867

PG 93x93 HL G80 120 180 Pad Saver Set - 10 pc

Sand Disc PG Mesh: 3 x Grit 80 / 3 x Grit 120 / 3 x Grit 180 / 1x Pad Saver

PG 100x147 HL G80 120 180 Pad Saver Set - 10 pc

Sand Disc PG Mesh: 3 x Grit 80 / 3 x Grit 120 / 3 x Grit 180 / 1x Pad Saver

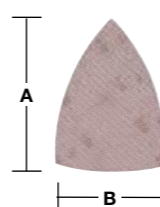
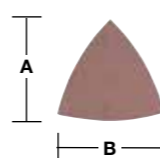

High Performance Delta Sanding Sheets HL

NEW

Grit	Paper size A x B (mm)	Pack quantity	Min. order quantity	Article Number	EAN Code
40	93 x 93	10	1	4932492275	4058546416423
60	93 x 93	10	1	4932492276	4058546416430
80	93 x 93	10	1	4932492277	4058546416447
120	93 x 93	10	1	4932492278	4058546416454
180	93 x 93	10	1	4932492279	4058546416461
240	93 x 93	10	1	4932492280	4058546416478
40	100x147	10	1	4932500172	4058546614744
60	100x147	10	1	4932500173	4058546614751
80	100x147	10	1	4932500174	4058546614768
120	100x147	10	1	4932500175	4058546614775
180	100x147	10	1	4932500176	4058546614782
240	100x147	10	1	4932500177	4058546614799
320	100x147	10	1	4932500178	4058546614805

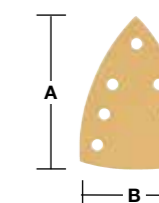
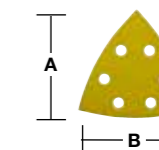

Standard Delta Sanding Sheets HL

Grit	Paper size A x B (mm)	Pack quantity	Min. order quantity	Article Number	EAN Code
40	93 x 93	10	1	4932492269	4058546416362
60	93 x 93	10	1	4932492270	4058546416379
80	93 x 93	10	1	4932492271	4058546416386
120	93 x 93	10	1	4932492272	4058546416393
180	93 x 93	10	1	4932492273	4058546416409
240	93 x 93	10	1	4932492274	4058546416416
40	147 x 100	10	1	4932492285	4058546416522
60	147 x 100	10	1	4932492286	4058546416539
80	147 x 100	10	1	4932492287	4058546416546
120	147 x 100	10	1	4932492288	4058546416553
180	147 x 100	10	1	4932492289	4058546416560
240	147 x 100	10	1	4932492290	4058546416567

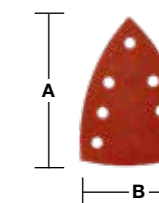
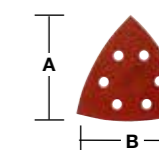

Abrasive belts

Cloth sanding belts for wood, metal, paint, lacquer, plaster.
Grit type: fused alumina, half open.
Artificial resin-bonded on special fabric.

Sanding belts 75 x 457 mm

Grit	Paper size A x B (mm)	Pack quantity	Min. order quantity	Article Number	EAN Code
40	457 x 75	5	1	4932480546	4058546408312
60	457 x 75	5	1	4932480547	4058546408329
80	457 x 75	5	1	4932480548	4058546408336
100	457 x 75	5	1	4932480549	4058546408343
150	457 x 75	5	1	4932480550	4058546408350



Sanding belts 75 x 533 mm

Grit	Paper size A x B (mm)	Pack quantity	Min. order quantity	Article Number	EAN Code
40	533 x 75	5	1	4932312475	4002395301263
60	533 x 75	5	1	4932312476	4002395301270
80	533 x 75	5	1	4932312477	4002395301287
100	533 x 75	5	1	4932312478	4002395301294
150	533 x 75	5	1	4932312479	4002395301300



Sanding Belts for Belt Sanders

Grit	Paper size A x B (mm)	Pack quantity	Min. order quantity	Article Number	EAN Code
40	560 x 100	5	1	4932492286	4058546416539
60	560 x 100	5	1	4932492287	4058546416546
80	560 x 100	5	1	4932492288	4058546416553
100	560 x 100	5	1	4932492289	4058546416560
150	560 x 100	5	1	4932492290	4058546416577



Sanding belts 100 x 610 mm

Grit	Paper size A x B (mm)	Pack quantity	Min. order quantity	Article Number	EAN Code
40	610 x 100	5	1	4932355066	4002395319824
60	610 x 100	5	1	4932355067	4002395319831
80	610 x 100	5	1	4932355068	4002395319848
100	610 x 100	5	1	4932355069	4002395319855
150	610 x 100	5	1	4932355070	4002395319862



Sanding belts 100 x 620 mm

Grit	Paper size A x B (mm)	Pack quantity	Min. order quantity	Article Number	EAN Code
40	620 x 100	5	1	4932341610	4002395304882
60	620 x 100	5	1	4932341611	4002395304899
80	620 x 100	5	1	4932341612	4002395304905
100	620 x 100	5	1	4932341613	4002395304912
150	620 x 100	5	1	4932341614	4002395304929

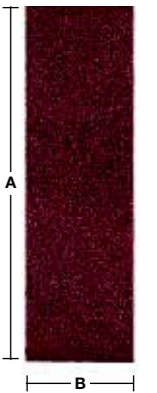

Sandpaper Rolls

Use for wood and paint.
Simply tear off to the desired size and punch in the hole pattern.
Also suitable for hand sanding blocks.
Grit options for 1/3" sheets: G40, G60, G80, G120, G150, G180.
Grit options for 1/2" sheets: G40, G60, G80, G120, G150, G180.

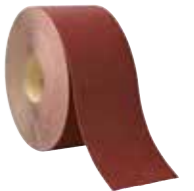

Description	Grit	Paper size A x B (mm)	Pack quantity	Min. order quantity	Article Number	EAN Code
1/3" Sheet Standard Rolls G40 - 1 pc	40	93x50000	1	1	4932501270	4058546639860
1/3" Sheet Standard Rolls G60 - 1 pc	60	93x50000	1	1	4932500198	4058546615000
1/3" Sheet Standard Rolls G80 - 1 pc	80	93x50000	1	1	4932500199	4058546615017
1/3" Sheet Standard Rolls G120 - 1 pc	120	93x50000	1	1	4932500200	4058546615024
1/3" Sheet Standard Rolls G150 - 1 pc	150	93x50000	1	1	4932500201	4058546615031
1/3" Sheet Standard Rolls G180 - 1 pc	180	93x50000	1	1	4932500202	4058546615048
1/2" Sheet Standard Rolls G40 - 1 pc	40	115x50000	1	1	4932501271	4058546639877
1/2" Sheet Standard Rolls G60 - 1 pc	60	115x50000	1	1	4932500203	4058546615055
1/2" Sheet Standard Rolls G80 - 1 pc	80	115x50000	1	1	4932500204	4058546615062
1/2" Sheet Standard Rolls G120 - 1 pc	120	115x50000	1	1	4932500205	4058546615079
1/2" Sheet Standard Rolls G150 - 1 pc	150	115x50000	1	1	4932500206	4058546615086
1/2" Sheet Standard Rolls G180 - 1 pc	180	115x50000	1	1	4932500207	4058546615093

Abrasive 4-sided Sponges

The four-sided sponge is flexible, adapts to surfaces, contours and shapes and reaches tight corners.
Equalizes the pressure distribution to create an even surface pattern.
Can be used on all sides.
Washable and can be reused, longer life.
For wet and dry sanding.
Can be used on wood, paint, metal and plaster to remove material.
Grits available: G60, G100, G180, G220.

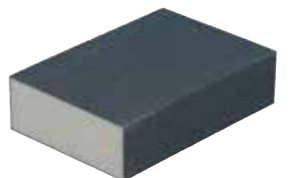

Grit	Paper size A x B (mm)	Pack quantity	Min. order quantity	Article Number	EAN Code
60	100x66x26	2	1	4932500208	4058546615109
100	100x66x26	2	1	4932500209	4058546615116
180	100x66x26	2	1	4932500210	4058546615123
220	100x66x26	2	1	4932500211	4058546615130

Abrasive Belts for Band File

Ceramic grain quality: Extremely high removal rate with best lifetime.
For grinding metal weld seams, contours, edges and profiles.
Suitable for all metals (steel, non ferrous metals, aluminium, titanium and stainless steel).
Ceramic grain produces low heat, preventing metal discolouration on stainless steel.
Abrasive Belts are suitable for M12 FBFL10 and M12 FBFL13.

Grit	Size (mm)	Pack quantity	Min. order quantity	Article Number	EAN Code
60	330 x 10	10	1	4932492874	4058546477455
80	330 x 10	10	1	4932492875	4058546477462
120	330 x 10	10	1	4932492876	4058546477479
60	457 x 13	10	1	4932492881	4058546477523
80	457 x 13	10	1	4932492882	4058546477530
120	457 x 13	10	1	4932492883	4058546477547



Fleece Belts for Band File

Non woven nylon fabric belts impregnated with abrasive grain for surface conditioning without damage to or removal of base material.
For fine grinding, deburring, matting and finishing on all metals inc. stainless steel.
Non Woven Fleece Belts are suitable for M12 FBFL10 and M12 FBFL13.

Grit	Size (mm)	Pack quantity	Min. order quantity	Article Number	EAN Code
Coarse	330 x 10	5	1	4932492877	4058546477486
Coarse	457 x 13	5	1	4932492884	4058546477554
Fine	330 x 10	5	1	4932492879	4058546477509
Fine	457 x 13	5	1	4932492886	4058546477578
Medium	330 x 10	5	1	4932492878	4058546477493
Medium	457 x 13	5	1	4932492885	4058546477561



Polishing Fleece Belts for Band File

Non woven nylon fabric belts impregnated with abrasive grain for effective cleaning, buffing and polishing.
Available in super-fine.
Non woven polishing fleece belts are suitable for M12 FBFL10 and M12 FBFL13.

Description	Size (mm)	Pack quantity	Min. order quantity	Article Number	EAN Code
Super-fine fleece belt	330 x 10	3	1	4932492880	4058546477516
Super-fine fleece belt	457 x 13	3	1	4932492887	4058546477585



ACCESSORIES

WIRE BRUSHES

Wire brushes are extremely effective for cleaning and preparing surfaces for painting, restoration and removing spatter after welding. Designed to be able to scrub dirt, rust, and other debris away from a variety of materials; including metal and wood; they can also be used to smooth and buff numerous surfaces.

MILWAUKEE® wire brushes are evenly shaped, allowing the wire to distribute heat evenly. All our wire brushes are easy to attach to our tools, making cleaning and surface prep quick and effortless.

MATERIAL	WORKPIECE MATERIAL						
	STEEL	STAINLESS STEEL (INOX)	ALUMINIUM	NON-FERROUS MEAL (SOFT)	NON-FERROUS MEAL (HARD)	CAST IRON	PLASTIC
STEEL WIRE	✓	✗	✗	✗	✗	✓	●
STAINLESS STEEL WIRE	●	✓	✓	●	●	✗	✗
BRASS WIRE	✗	✗	✗	✓	✗	✗	✗
SILICON CARBIDE WIRE (SIC)	✓	✓	✓	✗	●	✓	✓
CERAMIC WIRE (C)	✓	●	●	✗	✓	✓	✗

✓ - Highly recommended ● - Recommended ✗ - Not recommended

Cup brushes for small angle grinder, crimped

Cup brushes with crimped wire are used for medium duty brushing such as processing larger surfaces, rust removal and polishing, removal of paint, dirt and scale. The wire is highly flexible ensuring optimum adaptation to the workpiece contour to produce a fine surface finish. Use of high strength wire for aggressive brushing and therefore best removal results. Crimped, curved wire for maximum flexibility. Tight design for a longer service life. Suitable for 115mm and 125mm angle grinders.

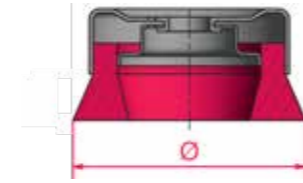

Diameter (mm)	Wire gauge	Type of wire	Shank reception	Pack quantity	Min. order quantity	Article Number	EAN Code
65	0.35mm	Steel	M14	1	1	4932501750	4058546644666
65	0.35mm	Stainless steel	M14	1	1	4932501751	4058546644673

Bevel brushes for small angle grinder, crimped

Bevel brushes with crimped wire are used for medium duty brushing such as working on hard to reach areas, rust removal and polishing, removal of paint, dirt and scale and for deburring. The wire is highly flexible ensuring optimum adaptation to the workpiece contour to produce a fine surface finish. Use of high strength wire for aggressive brushing and therefore best removal results. Tight design for a longer service life. Special designed shape for smooth, low vibration running. Suitable for 115mm and 125mm angle grinders.



Diameter (mm)	Height (mm)	Wire gauge	Type of wire	Shank reception	Pack quantity	Min. order quantity	Article Number	EAN Code
100	10	0.35mm	Steel	M14	1	1	4932501748	4058546644642
100	10	0.35mm	Stainless steel	M14	1	1	4932501749	4058546644659

Conical brushes for small angle grinder, knotted

Conical brushes with knotted wire are used for processing hard-to-reach areas, processing welding seams and for removing scale, rust, paint and slag. Left-hand knotted with a special flower shape for long lifetime. Use of high strength wire for aggressive brushing and therefore best removal results. Optimum and even knotting for smooth, lower vibration running. Suitable for 115mm and 125mm angle grinders.



Diameter (mm)	Height (mm)	Wire gauge	Type of wire	Shank reception	Pack quantity	Min. order quantity	Article Number	EAN Code
100	12	0.5mm	Steel	M14	1	1	4932501744	4058546644604
100	12	0.5mm	Stainless steel	M14	1	1	4932501745	4058546644611
115	12	0.5mm	Steel	M14	1	1	4932501746	4058546644628
115	12	0.5mm	Stainless steel	M14	1	1	4932501747	4058546644635

Wheel brushes for small angle grinder, knotted

Wheel brushes with knotted wire are used for pre and post processing of weld seams, aggressive removal of scale, rust and slag and for heavy brushing work. Wheel brushes with knotted wire in a narrow design (pipeline brushes) are used for professional processing of U / V weld seams and for cleaning of weld seams on pipe connections. Left-hand knotted with a special flower shape for long lifetime. Use of high strength wire for aggressive brushing and therefore best removal results. Optimum and even knotting for smooth, lower vibration running. Suitable for 115mm and 125mm angle grinders.

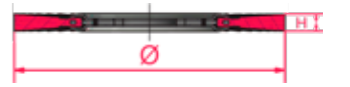

Diameter (mm)	Height (mm)	Wire gauge	Type of wire	Shank reception	Pack quantity	Min. order quantity	Article Number	EAN Code
115	14	0.5mm	Steel	M14	1	1	4932501738	4058546644543
115	14	0.5mm	Stainless steel	M14	1	1	4932501739	4058546644550
125	14	0.5mm	Steel	M14	1	1	4932501740	4058546644567
125	14	0.5mm	Stainless steel	M14	1	1	4932501741	4058546644574
125	6	0.5mm	Steel	M14	1	1	4932501742	4058546644581
125	6	0.5mm	Stainless steel	M14	1	1	4932501743	4058546644598

Cup brushes for small angle grinder, knotted

Cup brushes with knotted wire are used for heavy-duty brushing work on larger areas. They are designed for deburring, cleaning, derusting and descaling. Also suitable for preparing metal surfaces before painting, for removing slag, rust and concrete residue. Optimum and even knotting for smooth, lower vibration running. Use of high strength wire for aggressive brushing and therefore best removal results. Suitable for 115mm and 125mm angle grinders.

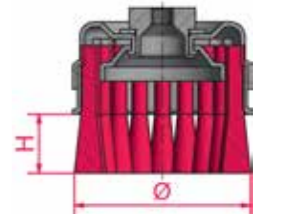

Diameter (mm)	Height (mm)	Wire gauge	Type of wire	Shank reception	Pack quantity	Min. order quantity	Article Number	EAN Code
65	18	0.5mm	Steel	M14	1	1	4932501735	4058546644512
65	18	0.5mm	Stainless steel	M14	1	1	4932501736	4058546644529
90	20	0.5mm	Steel	M14	1	1	4932501737	4058546644536

End brushes for straight grinder, knotted

End brushes with knotted wire are used for medium duty brushing such as cleaning corners, holes and moulds and for removing paint and rubber residue.

The knots will open according to the speed and therefore are great for processing hard-to-reach areas. They have almost the same application as end brushes with crimped wire, but with a more aggressive effect.

Optimum and even knotting for smooth, lower vibration running.

Special flower shape for long lifetime.

Use of high strength wire for aggressive brushing and therefore best removal results.

Suitable for straight grinders with max RPM of 20,000.

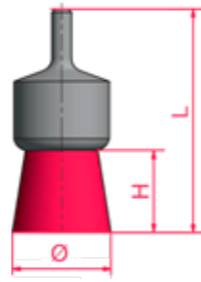

Diameter (mm)	Height (mm)	Length (mm)	Wire gauge	Type of wire	Shank reception	Pack quantity	Min. order quantity	Article Number	EAN Code
19	28	72	0.35mm	Steel	6 mm round shank	3	1	4932501730	4058546644468
19	28	72	0.35mm	Stainless steel	6 mm round shank	3	1	4932501731	4058546644475
22	28	72	0.35mm	Steel	6 mm round shank	3	1	4932501732	4058546644482
22	28	72	0.35mm	Stainless steel	6 mm round shank	3	1	4932501733	4058546644499
29	28	72	0.35mm	Steel	6 mm round shank	3	1	4932501734	4058546644505

End brushes for straight grinder, crimped

End brushes with crimped wire are used for light brushing such as cleaning corners, holes and moulds and for removing paint and rubber residues.

Best access to hard to reach areas such as drilled holes and cavities because the wires spread out / flare during rotation.

Ideal wire distribution for smooth, low vibration running.

Tight design for a longer life.

Suitable for straight grinders with max RPM between 18,000 - 20,000.

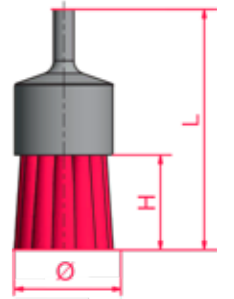

Diameter (mm)	Height (mm)	Length (mm)	Wire gauge	Type of wire	Shank reception	Pack quantity	Min. order quantity	Article Number	EAN Code
12	20	120	0.3mm	Steel	6 mm round shank	3	1	4932501726	4058546644420
12	20	120	0.3mm	Stainless steel	6 mm round shank	3	1	4932501727	4058546644437
17	20	65	0.3mm	Steel	6 mm round shank	3	1	4932501720	4058546644369
17	20	65	0.3mm	Stainless steel	6 mm round shank	3	1	4932501721	4058546644376
22	25	68	0.3mm	Steel	6 mm round shank	3	1	4932501722	4058546644383
22	25	68	0.3mm	Stainless steel	6 mm round shank	3	1	4932501723	4058546644390
30	25	68	0.3mm	Steel	6 mm round shank	3	1	4932501724	4058546644406
30	25	68	0.3mm	Stainless steel	6 mm round shank	3	1	4932501725	4058546644413

Wheel brushes for straight grinder, knotted

Wheel brushes with knotted wire are used for processing hard to reach areas, coarse brushing work, deburring and removing paint, scale or slag and for removing underbody protection in automotive applications.

Optimum and even knotting for smooth, lower vibration running.

Special flower shape for long lifetime.

Use of high strength wire for aggressive brushing and therefore best removal results.

Suitable for straight grinders with max RPM of 25,000.

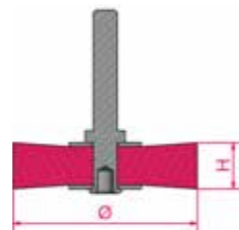

Diameter (mm)	Height (mm)	Wire gauge	Type of wire	Shank reception	Pack quantity	Min. order quantity	Article Number	EAN Code
75	12	0.5mm	Steel	6 mm round shank	3	1	4932501728	4058546644444
75	12	0.5mm	Stainless steel	6 mm round shank	3	1	4932501729	4058546644451

Cup brushes for straight grinder, crimped

Cup brushes with crimped wire are used for deburring, cleaning and processing small and medium-sized surfaces. Ideal for brushing on flat and easily accessible surfaces.

Use of special wires for the best results and longer lifetime.

Ideal wire distribution for smooth, low vibration running.

Suitable for straight grinders with max RPM between 6,000 - 10,500.

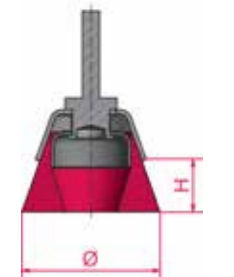

Diameter (mm)	Height (mm)	Wire gauge	Type of wire	Shank reception	Pack quantity	Min. order quantity	Article Number	EAN Code
50	20	0.3mm	Steel	6 mm round shank	3	1	4932501717	4058546644338
50	20	0.3mm	Stainless steel	6 mm round shank	3	1	4932501718	4058546644345
70	25	0.3mm	Steel	6 mm round shank	2	1	4932501719	4058546644352

Wheel brushes for straight grinder, crimped

Wheel brushes are used for general cleaning, smoothing, cleaning of weld seams, light deburring, and removal of corrosion and paint.

Wheel brushes with steel wire are used to remove rust and paint and to clean weld seams.

Wheel brushes with stainless steel wires are used for removing tempering colour from stainless steel weld seams. The stainless steel wire prevents contamination and rust.

Abrasive (silicon carbide or ceramic grain) wheel brushes are used for deburring stainless steel and aluminum. Use the ceramic grain for higher aggressiveness.

Highly flexible brush enables optimum adaptation to the workpiece contour and produces a fine surface finish.

Tight brush design for a longer life.

Suitable for straight grinders with max RPM between 15,000 - 20,000.

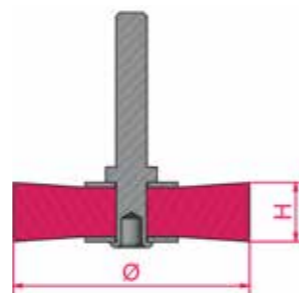

Diameter (mm)	Grit	Height (mm)	Wire gauge	Type of wire	Shank reception	Pack quantity	Min. order quantity	Article Number	EAN Code
30	-	6	0.2mm	Steel	6 mm round shank	3	1	4932501699	4058546644154
30	-	6	0.2mm	Stainless steel	6 mm round shank	3	1	4932501700	4058546644161
40	-	9	0.2mm	Steel	6 mm round shank	3	1	4932501701	4058546644178
40	-	9	0.2mm	Stainless steel	6 mm round shank	3	1	4932501702	4058546644185
50	-	11	0.3mm	Steel	6 mm round shank	3	1	4932501703	4058546644192
50	-	11	0.3mm	Stainless steel	6 mm round shank	3	1	4932501704	4058546644208
60	-	13	0.3mm	Steel	6 mm round shank	3	1	4932501705	4058546644215
60	-	13	0.3mm	Stainless steel	6 mm round shank	3	1	4932501706	4058546644222
70	-	9	0.3mm	Steel	6 mm round shank	3	1	4932501707	4058546644239
70	-	9	0.3mm	Stainless steel	6 mm round shank	3	1	4932501708	4058546644246
50	-	10	0.2mm	Brass	6 mm round shank	3	1	4932501709	4058546644253
70	-	12	0.2mm	Brass	6 mm round shank	3	1	4932501710	4058546644260
50	120	10	1.1mm	Silicon carbide grain	6 mm round shank	3	1	4932501711	4058546644277
50	320	10	0.6mm	Silicon carbide grain	6 mm round shank	3	1	4932501712	4058546644284
70	120	12	1.1mm	Silicon carbide grain	6 mm round shank	3	1	4932501713	4058546644291
70	320	12	0.6mm	Silicon carbide grain	6 mm round shank	3	1	4932501714	4058546644307
50	120	10	1.1mm	Ceramic grain	6 mm round shank	3	1	4932501715	4058546644314
50	320	10	0.6mm	Ceramic grain	6 mm round shank	3	1	4932501716	4058546644321

Premium polishing accessories - sponges

Description	Diameter (mm)	Thickness (mm)	Pack quantity	Min. order quantity	Article Number	EAN Code
Sponge Red Coarse 140 / 20 mm	140	20	2	1	4932492310	4058546416775
Sponge Red Coarse 140 / 25 mm	140	25	2	1	4932492319	4058546416867
Sponge Red Coarse 160 / 20 mm	160	20	2	1	4932492316	4058546416836
Sponge Yellow Fine 140 / 20 mm	140	20	2	1	4932492311	4058546416782
Sponge Yellow Fine 140 / 25 mm	140	25	2	1	4932492320	4058546416874
Sponge Yellow Fine 160 / 20 mm	160	20	2	1	4932492317	4058546416843
Sponge Blue Ultra Fine 140 / 20mm	140	20	2	1	4932492312	4058546416799
Sponge Blue Ultra Fine 140 / 25 mm	140	25	2	1	4932492321	4058546416881
Sponge Blue Ultra Fine 160 / 20 mm	160	20	2	1	4932492318	4058546416850



Premium polishing accessories - cloths

Description	Length (mm)	Width (mm)	Pack quantity	Min. order quantity	Article Number	EAN Code
Cloth Red 400 x 400 mm	400	400	2	1	4932492306	4058546416737
Cloth Yellow 400 x 400 mm	400	400	2	1	4932492307	4058546416744
Cloth Blue 400 x 400 mm	400	400	2	1	4932492308	4058546416751



Premium Polishing Accessories - compounds

Description	Pack quantity	Min. order quantity	Article Number	EAN Code
Compound Red Coarse 11 Polish 1500 compound. A coarse 1500 grit polish for removing deep scratches without damaging the lacquer. Suitable for removing dust grains, orange peel texture, lacquer/paints runs and deep scratches. Free of wax, silicone and toxic solvents. Recommended for use with polishing red hard coarse sponge and red cloth.	1	1	4932492300	4058546416676
Compound Yellow Fine 11 Polish 2000 compound. A coarse 2000 grit polish for removing fine scratches without damaging the lacquer. Free of wax, silicone and toxic solvents. Recommended for use with polishing yellow soft fine sponge and yellow cloth.	1	1	4932492301	4058546416683
Compound Blue Ultra Fine 11 Polish compound 3000. A medium fine compound with 3000 grit for removing fine scratches, holograms and swirls. Free of silicone. Recommended for use with polishing super fine blue sponge and blue microfibre polishing cloth.	1	1	4932492302	4058546416690



Hook & Loop Ø 125 mm

Description	Diameter (mm)	Height (mm)	Pack quantity	Min. order quantity	Article Number	EAN Code
Polishing backing pad with M14 thread. Very flat design with excellent flexibility. Low vibration allows precise work on any flat and curved profiles	125	-	1	1	4932430394	4002395380558
Lambswool polishing disc. 100% natural lambswool. Premium quality with extremely high fibre density for longer lifetime. Integrated soft touch layer guarantees perfect adjustment to flat and curved profiles. For finishing old and fresh paint. Extremely good polishing of temperature sensitive clear lacquers thanks to heat resistant fibres, e.g. polishing car bumper	135	25	1	1	4932430395	4002395380565
Microfibre polishing cloth. Super-soft premium microfibre polishing cloth for finishing gloss polishing. With good absorption properties perfectly suited for final finishing and removing water spots from sensitive surfaces. Machine-washable with 30° without softener	-	-	1	1	4932430398	4002395380596

①



②



③



Polishing accessories - hook & loop Ø 125/150 mm

Description	Diameter (mm)	Height (mm)	Pack quantity	Min. order quantity	Article Number	EAN Code
Polishing backing pad. Application: Reception of felt / lambswool polishing discs and sponges. Characteristics: M14 thread, break resistant with integrated soft and flexible foam layer, Hook & Loop fixation	150	25	1	1	4932373161	4002395347285
Felt polishing disc. Application: second polishing / finish of new lacquer work (spray mist and inclusion of dust), non ferrous metals and stainless steel, can also be used with polishing paste. Requires polishing backing	150	25	1	1	4932373163	4002395347902
Lambswool polishing disc. Finishing high gloss polishing	150	25	1	1	4932373164	4002395347926
Polishing sponge hard. Polish up of weather-beaten lacquer, lacquer re-conditioning	150	50	1	1	4932373165	4002395347940
Polishing sponge soft. Second polish of lacquer, lacquer care	150	50	1	1	4932373186	4002395347964

①



②



③



④



⑤



Spot polisher

Description	Diameter (mm)	Height (mm)	Pack quantity	Min. order quantity	Article Number	EAN Code
Polishing / Sanding backing pad. Thread: M9 x 0.75. Hook and loop fixation. For use with polishing sponges and abrasive paper	76	-	1	1	4932430488	4002395381494
Polishing sponge - Hard (yellow). Hard sponge for use with more aggressive polish for removal of deep scratches. Hook and loop fixation. For use with polishing / sanding backing pad	75	25	1	1	4932430489	4002395381500
Polishing sponge - Soft (white). Soft sponge for use with light polish for removal of small scratches. Hook and loop fixation. For use with polishing / sanding backing pad	80	25	1	1	4932430490	4002395381517
Lambswool polishing pad. Hook and loop fixation. For use with polishing / sanding backing pad	80	-	1	1	4932430838	4002395385003
Fibre disc backing pad. Thread: M9 x 0.75 to affix to tool. Knurled thread to fix coated abrasives and surface finishing products for coarse sanding applications, such as rust removal. Ideal for sanding small or awkward to reach areas such as pinch welds, door shuts and wheel arches	46	-	1	1	4932430492	4002395381531

①



②



③



④



⑤



System attachments - wet diamond drilling

Description	Fits DD3-152	Fits DCM2-250C & DCM2-350C	Fits MXF DCD150	Pack quantity	Min. order quantity	Article Number	EAN Code
Fixing kit	✓	✓	✓	9	1	4932399731	4002395363827
① Stud bolt, setting tool, wing nut, washer and 5 pcs M12 drop anchor							
1 3/8" open ended spanner. For holding the motor output spindle while removing a core bit		✓		1	1	49964705	04524222766
② 32 mm ended spanner. For holding the motor output spindle while removing a core bit.	✓			1	1	4931428009	4002395844791
41 mm open ended spanner. For removing the core bit from the motor spindle.	✓	✓		1	1	4931428010	4002395844807
③ 1 1/4" female to 1/2" female adaptor. To enable the connection of <50 mm diamond core bits on a 1 1/4" machine spindle thread	✓	✓		1	1	4932352627	4002395372850
④ 1 1/4" female / male extension rod, length 300 mm	✓	✓	✓	1	1	4932399724	4002395363759
1 1/4" female / male extension rod, length 500 mm	✓	✓	✓	1	1	4932399725	4002395363766
⑤ Telescopic extension. Extension pole used to fix drill rig to the ground instead of anchor bolts. Maximum load of 500 kg and adjustable extension height from 1.8-2.9 m	✓	✓	✓	1	1	4932399732	4002395363834
⑥ Vacuum pump VP6	✓	✓	✓	1	1	4932352094	4002395367474
⑦ WT 10 watertank	✓	✓	✓	1	1	4932399726	4002395363773
⑧ Water collection ring: For use with drill rig DR 152 T. For use with max. Ø 152 mm core bits				1	1	4932478073	4058546340063
⑨ Water collection ring: max. Ø 180 mm			✓	1	1	4932399727	4002395363780
Replacement rubber ring for DR 250 TV			✓	1	1	4932399729	4002395363803
⑩ Water collection ring: For use with drill rig DR 350 T. For use with max. Ø 300 mm core bits				1	1	4932399728	4002395363797
Replacement rubber ring for DR 350 T				1	1	4932399730	4002395363810
⑪ Quick connection motor mounting plate. Included in both drill rigs DR 250 TV and DR 350 T		✓		1	1	4932399733	4002395363841
⑫ Water collection ring: For universal use with diamond drilling tools. For use with max. Ø 152 mm core bits	✓	✓	✓	1	1	4932478073	4058546340063
⑬ Guide rod for DD3-152. Requires SDS-plus pilot drill (Ø 8 x 110 mm)	✓	✓	✓	1	1	4932352679	4002395373376

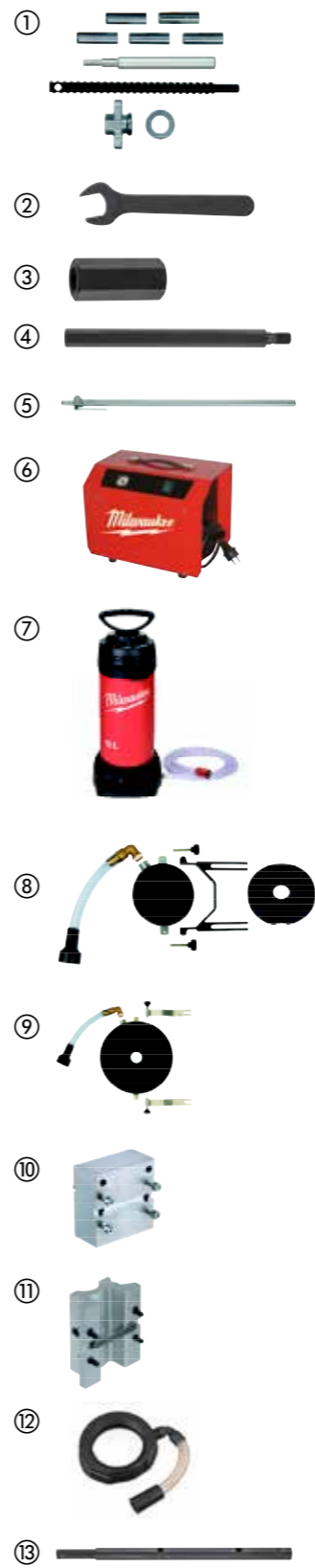

Rotary hammers - System attachments

Rotary hammer chuck adaptors

Tool Drive	Reception	Id. No. 4932	EAN Code 4002395
① FIXTEC	SDS-Plus	379877	346561
② FIXTEC	SDS-Plus	399152	357628
③ FIXTEC	SDS-Plus	352299	369584
④ FIXTEC	1/2" x 20 UNF	371807	344710
⑤ FIXTEC	1/2" x 20 UNF	399154	357635
⑥ SDS-Plus	1/2" x 20 UNF	367438	337668
⑦ SDS-Plus	1/2" x 20 UNF	367166	334438

⑤ Only suitable for PLH 16 QEX, V28 HX, V18 HX, PLH 26 QEX, PH 30 Power X, KH 26 XE, KH 24 XE, KH 28 Super XE, BH 26 LXE and PH 26 X.

⑥ Chuck adaptor with direct bit reception (1/4" Hex) to accept screwdriving bits. Threaded housing enables adaptor to be tightened to the chuck resulting in no wobble.

⑦ Chuck adaptor with retaining screw.



Keyed chucks

Chuck jaws open (mm)	Drill reception	Locking device	Safety screw	Rotary drill	Percussion drill	Battery drill	Chuck key	Pack quantity	Min. order quantity	Article Number	EAN Code
1.5-13	1/2" x 20	✓	✓	✓	✓	✓	A	1	1	4932267980	4002395300488
3.0-16	Taper B16			✓			C	1	1	4932127010	4002395306169
3.0-16	M18x2.5	✓	✓	✓	✓		C	1	1	4932320014	4002395310784

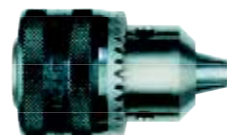

Keyed chucks - machine specific

Chuck jaws open (mm)	Drill reception	Fits Milwaukee Drill Drivers	Safety screw	Chuck key	Pack quantity	Min. order quantity	Article Number	EAN Code
1.0-10	3/8" x 24	HDE 6 RQ	✓	H	1	1	48660817	045242155705



Keyed chucks with 1/4" Hex reception

Chuck jaws open (mm)	Drill reception	Battery drill	Chuck key	Pack quantity	Min. order quantity	Article Number	EAN Code
1.0-10	1/4" Hex	✓	A	1	1	4932314867	4002395300112



Chuck keys

Description	Type	Ref. No.	Pack quantity	Min. order quantity	Article Number	EAN Code
① Chuck key	A	S2A	1	1	4932221378	4002395302765
	B	S2AT	1	1	4932310612	4002395309177
	C	S3T	1	1	4932221379	4002395306381
	D	S14	1	1	4932304684	4002395300105
	E	S4	1	1	4932221380	4002395306398
	G	S2	1	1	4932319995	4002395303724
	H		1	1	48663350	045242157600
	J		1	1	48663240	045242157501
	K		1	1	48663280	045242157556
	② Morse taper No. 3 adaptor for chucks with B16 taper	MT3 - B16		1	1	4932117042
Ejector tool DIN 317 size 3			1	1	4932604226	4002395311248



* while stocks last

Keyless chucks

Keyless chucks 2 sleeves

Chuck jaws open (mm)	Reception	Locking device	Safety screw	Rotary drill	Percussion drill	Battery drill	Pack quantity	Min. order quantity	Article Number	EAN Code
1.0-10	3/8" x 24		✓	✓		✓	1	1	4932349457	4002395318155
1.0-10	1/2" x 20	✓	✓	✓	✓	✓	1	1	4932364382	4002395337675
1.5-13	1/2" x 20	✓		✓	✓	✓	1	1	4932376531	4002395346332
1.5-13	1/2" x 20	✓	✓	✓	✓	✓	1	1	4932376533	4002395346349
1.5-13	1/2" x 20	✓		✓	✓	✓	1	1	4932364265 ¹	4002395334056
1.5-13	1/2" x 20	✓	✓	✓	✓	✓	1	1	4932364267	4002395334070



¹ Industrial quality

Keyless chucks for FIXTEC (spindle lock) machines

Chuck jaws open (mm)	Reception	Locking device	Safety screw	Rotary drill	Percussion drill	Battery drill	Pack quantity	Min. order quantity	Article Number	EAN Code
1.0-10	3/8" x 24	✓	✓	✓	✓	✓	1	1	4932371018	4002395339365
1.0-10	1/2" x 20	✓	✓	✓	✓	✓	1	1	4932372443	4002395345458
1.5-13	1/2" x 20	✓	✓	✓	✓	✓	1	1	4932371913	4002395345366
1.5-13	3/8" x 24	✓	✓	✓	✓	✓	1	1	4932399492	4002395361137
1.5-13	9/16" x 18	✓	✓	✓	✓	✓	1	1	4932478806 ¹	4058546360887



¹ Fits M18 FDD(2)/ M18 FPD(2)

Industrial keyless chucks for corded percussion drills

Chuck jaws open (mm)	Reception	Locking device	Rotary drill	Percussion drill	Battery drill	Pack quantity	Min. order quantity	Article Number	EAN Code
1.0-13	1/2" x 20	✓	✓	✓		1	1	4932364266	4002395334063



Keyless chucks - specific tool related chucks

Chuck jaws open (mm)	Reception	Machine specific	Locking device	Rotary drill	Safety screw	Pack quantity	Min. order quantity	Article Number	EAN Code
① 1.0-10	1/2" x 20	HDE 10 RQX			✓	1	1	48661520	045242156795
① 1.5-13	1/2" x 20	HDE 13 RQX			✓	1	1	42660755	4002395891436
② 1.5-13	FIXTEC		✓	✓		1	1	4932399214	4002395358236
③ 1.0-10	FIXTEC	M12 BDDX		✓		1	1	4932430444	4002395381050

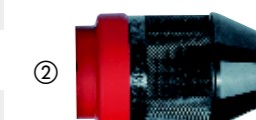

System attachments - planers

Description	All planers 82 & 102mm	Pack quantity	Min. order quantity	Article Number	EAN Code
Parallel guide	✓	1	1	4932274071*	4002395300358
Folding rebate depth gauge. For all planers except H500 / PR 1.6-82 models	✓	1	1	4932274069	4002395300129

Planer blades

Description	Width (mm)	Fits planers	Pack quantity	Min. order quantity	Article Number	EAN Code
	56.1 mm	M12 BLP	2	1	4932493399	4058546482701
Tungsten carbide reversible blades. Two reversible blades, suitable for soft and hardwoods	82 mm	M18 BP, H 500, H 750	2	1	4932273484	4002395300150
	102 mm	HB 750, HBE 800	2	1	4932316243	4002395300167



HAND TOOLS



MEASURING, MARKING & LEVELS

STEP UP WITH MILWAUKEE® TAPES

LED MAGNETIC



INTEGRATED 100 LUMEN LED WITH 2.5 HOURS OF RUN-TIME
FINGER STOP
STRAIGHTEST STANDOUT
USB CHARGING PORT
IP54 RATED
MAGNETIC
30MM BLADE WIDTH
4.5M STANDOUT

COMMERCIAL CONSTRUCTION



SLIMMEST DESIGN
IMPACT RESISTANT
NEW WIRE FORM CLIP
ERGONOMIC GRIP
2.5M STANDOUT

FINISHED SPACES & MOST TRADES



WIDE BLADE



WIDEST BLADE
35MM BLADE WIDTH
LONGEST STRAIGHTEST STANDOUT
IMPACT RESISTANT
DUAL SIDE PRINT
FINGER STOP
NYLON BLADE COATING
5M STANDOUT

FRAMING / WOODEN BEAM ENVIRONMENTS



COMPACT
SIDE STANDOUT UP TO 2M
FINGER STOP
ANTI TEAR COATING
IMPACT RESISTANT
NEW WIRE FORM CLIP
25MM BLADE WIDTH
3.2M STANDOUT

FINISHED SPACES



WIDE BLADE MAGNETIC



WIDEST BLADE
35MM BLADE WIDTH
MAGNETIC
LONGEST STRAIGHTEST STANDOUT
IMPACT RESISTANT
DUAL SIDE PRINT
FINGER STOP
NYLON BLADE COATING
5M STANDOUT

METAL FRAMING / COMMERCIAL CONSTRUCTION



AUTOLOCK
SIDE STANDOUT UP TO 2M
ANTI TEAR COATING
IMPACT RESISTANT
NEW WIRE FORM CLIP
25MM BLADE WIDTH
3.2M STANDOUT

FINISHED SPACES



STUD



EXO 360 RIP & WEAR RESISTANT BLADE TECHNOLOGY
SMOOTHEST BLADE RETRACTION
MOST DURABLE
DOUBLE SIDED ANTI TEAR COATING
FINGER STOP
STRAIGHT STANDOUT
DUAL SIDE PRINT
HIGH-VIS BLADE
IMPACT RESISTANT
33MM BLADE WIDTH
4.5M STANDOUT

OUTDOOR GROUNDWORK



MAGNETIC
DUAL SIDE PRINT
FINGER STOP
STRAIGHTEST STANDOUT
DOUBLE SIDED ANTI TEAR COATING
MAGNETIC
IMPACT RESISTANT
30MM BLADE WIDTH

COMMERCIAL CONSTRUCTION



STUD™ Tape Measure (Gen 3)

NEW

STUD



- High-Vis blade color for improved readability, specially developed for outdoor/groundwork applications.
- Longest lasting blade with EXO 360™ rip & wear resistant full nylon blade coating.
- Smoothest blade retraction for less blade bending in harsh groundwork conditions.
- Impact resistant body for the toughest conditions on the job site.
- Highest blade durability with Double-Sided Anti-Tear coating for the first 15 cm of the blade.
- Blade width of 33 mm ensures blade stability and stiffness.
- Finger-Stop feature for quick, controlled retraction of the blade.
- Standout: Measure distances in the air of up to 4.5 m.
- Double-Sided printing with vertical and horizontal scale for versatile measurements.
- Architectural scale to measure scaled drawings, such as blueprints.



Length (m)	Blade width (mm)	Pack quantity	Min. order quantity	Article Number	EAN Code
5	33	1	6	4932498763	4058546526320
5 / 16ft	33	1	6	4932498764	4058546526337
8	33	1	6	4932498765	4058546526344
8 / 26ft	33	1	6	4932498766	4058546526351
10	33	1	6	4932498767	4058546526368



HANDTOOLS

Tape Measure WIDE BLADE (Gen II)

NEW

WIDE BLADE
WIDE BLADE



- Longest Standout: Measure distances in the air of up to 5 m.
- Straightest Standout for more precise measurement of long distances in the air.
- The widest blade on the market at 35 mm provides more stability and stiffness of the blade.
- Finger-Stop feature for quick, controlled retraction of the blade.
- Improved blade durability with Double-Sided Anti-Tear coating for the first 15 cm of the blade.
- Long-lasting blade with full nylon extrusion coating.
- Impact resistant body for the toughest conditions on the job site.
- Double-Sided printing with vertical and horizontal scale for versatile measurements.
- Architectural scale to measure scaled drawings, such as blueprints.

Length (m)	Blade width (mm)	Magnetic	Pack quantity	Min. order quantity	Article Number	EAN Code
5	35		1	6	4932499203	4058546563677
5 / 16ft	35		1	6	4932499204	4058546563684
8	35		1	6	4932499205	4058546563691
8 / 26ft	35		1	6	4932499206	4058546563707
5	35	✓	1	6	4932499207	4058546563714
5 / 16ft	35	✓	1	6	4932499208	4058546563721
8	35	✓	1	6	4932499209	4058546563738
8 / 26ft	35	✓	1	6	4932499210	4058546563745

Tape Measure AUTOLOCK (Gen II)

NEW

AUTO-LOCK



- Longest side standout feature to measure sideways with up to 2m.
- Autolock feature locks the blade automatically for more blade control.
- Standout: Measure distances in the air of up to 3.2 m.
- Wire-form belt clip to reduce pocket wear and tear.
- Ergonomic design for more control and grip.
- Anti-Tear coating for the first 15 cm of the blade for more durability.
- Lanyard hole for secure attachment.

Length (m)	Blade width (mm)	Pack quantity	Min. order quantity	Article Number	EAN Code
5	25	1	6	4932498772	4058546526412
8	25	1	6	4932498774	4058546526436

Tape Measure MAGNETIC (Gen IV)

NEW

MAGNETIC



- Standout: Measure distances in the air of up to 4.5 m.
- Straighter stiffer blade for more precise measurement of long distances in the air.
- Blade width of 30 mm ensures blade stability and stiffness.
- Smoothest blade retraction with more speed and less blade rollover.
- Finger-Stop feature for quick, controlled retraction of the blade.
- Highest blade durability with Double-Sided Anti-Tear coating for the first 15 cm of the blade.
- Impact resistant body for the toughest conditions on the job site.
- Double-Sided printing with vertical and horizontal scale for versatile measurements.
- Architectural scale to measure scaled drawings, such as blueprints.
- Strong magnetic hook for maximum holding power.

Length (m)	Blade width (mm)	Pack quantity	Min. order quantity	Article Number	EAN Code
5	30	1	6	4932498768	4058546526375
5 / 16ft	30	1	6	4932498769	4058546526382
8	30	1	6	4932498770	4058546526399
8 / 26ft	30	1	6	4932498771	4058546526405

Tape Measure COMPACT (Gen II)

NEW

COMPACT



- Longest side standout feature to measure sideways with up to 2m.
- Finger-Stop feature for quick, controlled retraction of the blade.
- Standout: Measure distances in the air of up to 3.2 m.
- Wire-form belt clip to reduce pocket wear and tear.
- Ergonomic design for more control and grip.
- Anti-Tear coating for the first 15 cm of the blade for more durability.
- Lanyard hole for secure attachment.

Length (m)	Blade width (mm)	Pack quantity	Min. order quantity	Article Number	EAN Code
3	19	1	12	4932498776	4058546526450
5	25	1	12	4932498778	4058546526474
5 / 16ft	25	1	12	4932498779	4058546526481
8	25	1	6	4932498780	4058546526498
8 / 26ft	25mm	1	6	4932498781	4058546526504

LED Magnetic Tape Measure 7.5 m

- 100 Lumens LED light, to illuminate up to 3 m work area.
- Conveniently charge MILWAUKEE® Rechargeable internal battery with included micro-USB cable.
- Charging indicator red/ orange/ green to be able to read out the charging status of the battery.
- 2.5 hour of battery run time.
- 30 mm blade with double sided printing on tape for easier readability and architect scale provides easy calculating of scaled drawings.
- Improved standout up to 4.6 m.
- Finger stop for comfortable hold and finger protection when the blades retracts.
- Strong magnet at start of the tape allows easy hooking onto flat surfaces and round pipe.
- Overmold gripping area for extra comfort and durability.
- Anti-tear coating - reinforces the first 15 cm of the blade.
- Nylon non-reflective bond blade protection, up to 10x more resistant to jobsite damage.
- Class II accuracy.



Description	Length (m)	Blade width (mm)	Pack quantity	Min. order quantity	Article Number	EAN Code
LED Magnetic Tape Measure 7.5 m	7.5	30	1	6	4932492469	4058546418366

Tape measure with LED Light

- 19 LUX LED Light: helps finding measured spot.
- Nylon lacquer blade protection against debris, dirt and water.
- 4 Point reinforced housing for outstanding tape lifetime.
- ABS housing with impact resistant overmold for more comfort and jobsite durability.
- Compact design and comfortable size.
- Magnet on the rear side of the tape for attaching to metal tool boxes and other metal surfaces.
- 2x CR2016 batteries are included in the delivery scope.
- Class II accuracy.
- Bulk packed, order in multiples of 12 pcs.



Description	Length (m)	Blade width (mm)	Pack quantity	Min. order quantity	Article Number	EAN Code
3 m/ 10 ft tape measure with LED	3	12	1	12	4932501678	4058546643942

Tape Measure SLIM (Gen II)

NEW

SLIM



- Most compact design - ideal for measurements in confined spaces.
- Ergonomic design for more control and grip.
- Highest Durability with impact resistant body.
- New wire-form belt clip to reduce pocket wear and tear.
- Lanyard hole for secure attachment.

Length (m)	Blade width (mm)	Pack quantity	Min. order quantity	Article Number	EAN Code
3	16	1	12	4932498782	4058546526511
5	19	1	12	4932498783	4058546526528
8	25	1	12	4932498785	4058546526542

Tape measure - 2 m / 6 ft



- 5-point reinforced frame for job site durability.
- Heavy duty blade with 13 mm blade width.
- Double sided nylon bond blade protection for extreme tape durability against dust, dirt, debris and water.
- Compact design and overmould gripping area for extra comfort and durability.
- Bulk packed, order in multiples of 12 pcs.

Description	Length (m)	Pack quantity	Min. order quantity	Article Number	EAN Code
2 m/ 6 ft metric & imperial tape measure	2	1	12	4932501679	4058546643959

Pipe Groove Tape Measure

- Dual-Sided Blade Printing: Go/No-Go Gauge and 1/100in scale.
- 5-Point reinforced body delivers tough protection against drops and impacts.
- Durable blade protection for reduces wear and tear.
- High contrast white blade color for improved readability.
- Keychain and magnet for easy storage.

NEW



Description	Magnetic	Pack quantity	Min. order quantity	Article Number	EAN Code
Pipe Groove Tape Measure	✓	1	1	4932500648	4058546619503

Composite folding rule

- Locks at 90°/180°.
- Angle reference, rust free.
- Water resistant.
- Wear resistant markings.



Description	Length (m)	Blade width (mm)	Accuracy	Links	Hinge	Pack quantity	Min. order quantity	Article Number	EAN Code
Composite folding rule	2	15 x 3.20	Class 2	10	Plastic and stainless steel	1	10	4932459301	4058546002671

Wood folding rule

- Locks at 90°/180°.
- Angle reference.



Description	Length (m)	Blade width (mm)	Accuracy	Links	Hinge	Pack quantity	Min. order quantity	Article Number	EAN Code
Wood folding rule	2	16 x 3.20	Class 3	10	Brass	1	10	4932459302	4058546002688

Slim wood folding rule

- Locks at 180°.
- Flexible slim design.



Description	Length (m)	Blade width (mm)	Accuracy	Links	Hinge	Pack quantity	Min. order quantity	Article Number	EAN Code
Slim wood folding rule	2	16 x 2.70	Class 3	10	Brass	1	10	4932459303	4058546002695

Long open tapes

- Steel blade design with nylon clad (extra thick nylon coating) for increased durability.
- Best in class stretch performance: up to 50% less stretch vs. fiberglass tapes.
- Ultra durable design: reinforced metal handle and drop durability.
- 3:1 clutched planetary gearing for 10x longer gear durability and smooth rewind.
- GRIME GUARD: debris wiper keeps blade clean and clear of abrasive material.
- Class II accuracy.
- 2 sided scale printing. Metric measurements shown on the top side and imperial (inches and feet) on the underside of the blade.

Description	Length (m)	Blade width (mm)	Pack quantity	Min. order quantity	Article Number	EAN Code
① Long open tape combi 30 m/ 100 ft	30	13	1	1	4932501121	4058546624231
② Long open tape combi 100 m/ 330 ft	100	9.5	1	1	4932501122	4058546624248



Fibreglass long tapes

- Fibreglass blade ensures a low tape weight.
- 3:1 clutched planetary gearing for 10x longer gear durability and smooth rewind.
- GRIME GUARD: debris wiper keeps blade clean and clear of abrasive material.
- 2 sided scale printing. Metric measurements shown on the top side and imperial (inches and feet) on the underside of the blade.

Description	Length (m)	Blade width (mm)	Pack quantity	Min. order quantity	Article Number	EAN Code
① Fibreglass long tape combi 30 m/ 100 ft	30	13	1	1	48225330	045242527731
② Fibreglass long tape combi 60 m/ 200 ft	60	13	1	1	48225360	045242527748



Long closed tapes

- Single sided 30 m metric tape with 9.5 mm blade width.
- GRIME GUARD: debris wiper keeps blade clean and clear of abrasive material.
- Ultra durable design: reinforced metal frame housing, reinforced handle and steel blade with nylon coating.
- 3:1 clutched planetary gearing for 10x longer gear durability and smooth rewind.
- Class II accuracy.



Description	Length (m)	Blade width (mm)	Pack quantity	Min. order quantity	Article Number	EAN Code
Long closed tape 30 m	30	9.5	1	1	4932501123	4058546624255

30 m Laser distance meter

NEW

- Easy to use one person point and shoot system
- IP54 water & dust protection
- Auto shut off and low power indication
- Metric & Imperial units of measurement
- Very slim housing design with belt clip for easy transport
- Two easy to touch measure buttons on the front and side of the housing
- Enables user to perform single measurements & continuous tracking
- Large 3 line LCD graphical display with automatic white backlight
- Display shows last three measurements



Description	Dimensions (Outer) (H x W x D / mm)	Range (m)	Pack quantity	Min. order quantity	Article Number	EAN Code
30 m Laser distance meter	101 x 38 x 28	0.15 - 30	1	1	4933459276	4058546002428

50 m Laser distance meter

NEW

- Easy to use one person point and shoot system
- Very slim housing design with belt clip for easy transport
- Area/volume/indirect height and patent pending surface measurement
- Min/Max sweep & continuous tracking
- Distance addition & subtraction for layouting
- Indirect height measurements (Pythagoras 2-point, 3-point, partial height)
- Large 3 line LCD graphical display with automatic white backlight
- Fold-out end piece for diagonal corner measurements
- Memory recall for the last 20 measurements
- IP54 water & dust protection
- Auto shut off and low power indication
- Metric units of measurement only



Description	Dimensions (Outer) (H x W x D / mm)	Range (m)	Pack quantity	Min. order quantity	Article Number	EAN Code
50 m Laser distance meter	119 x 40 x 32	0.05 - 50	1	1	4933447700	4002395006540

Digital levels



- PINPOINT measurement technology provides layers of information to include numeric, graphic, color and audio for advanced readability.
- PIN Mode allows user to lock in any target within 360° for replicating measurements or finding a specific measurement.
- Powered by REDLITHIUM™ USB rechargeable battery.
- Up to 2x greater accuracy.
- Simple menu selection for quick set-up: Mode, Sensitivity, Tolerance, Power and Language.
- Tolerance can be adjusted for precision, standard and rough-in work.
- IP65 rated protects against job site debris.
- Accurate to: 0°, 90°/0.03° and 1°-89°/0.10°.
- Durable all-metal hang hole for easy storage.



Description	Length (cm)	Handles	Pack quantity	Min. order quantity	Article Number	EAN Code
Digital level 60 cm	60	0	1	1	4933471978	4058546298777
Digital level 120 cm	120	2	1	1	4933471979	4058546298784

Digital Angle Gauge

- Real-time measurements for quicker readings and to save time by reducing unnecessary screen delays.
- Easy digital navigation with an auto-rotating LCD screen.
- Angle assist arrows that point to the nearest 90-degree for quick angle finding.
- Auto-shutoff feature saves battery life.
- Hold mode to fix the current measured value in the display.
- Magnet to securely attach to metal surfaces for increased productivity.
- Compact design for lightweight and handy use.
- Accuracy ±0.1° at 0° and 90°; ±0.2° between 1° and 89°.
- Includes a soft carrying case for easy and convenient storage and 2 x AAA batteries.



Description	Min. order quantity	Pack quantity	Article Number	EAN Code
Digital Angle Gauge	1	1	4932493656	4058546485276

Expandable level



- Cover any length from 200 cm - 366 cm with laser etched measurements.
- SHARPSITE™ vial technology improves the readability of the vial.
- Reinforced internal components protect the level from damage or wear.
- Precision milled measuring surface provides accuracy in all working positions.
- Accurate to 0.029° (0.0005" / in, 0.5 mm / m) in normal and reverse position.
- High contrast vial system is easy to clean and optimises visibility.
- Full grip frame for improved ergonomics in transport & application.
- Secure tool-removable stand offs.



Description	Length (cm)	Handles	Pack quantity	Min. order quantity	Article Number	EAN Code
Expandable 200 cm - 366 cm	200 - 366	2	1	1	4932471355	4058546289836



REDSTICK™ BACKBONE™ box levels



- Reinforced BACKBONE™. Strong and durable frame. Reinforced vial retention.
- SHARPSITE™ vial technology improves the readability of the vial.
- Wide, durable handles for comfort and portability.
- Precision milled measuring surface provides accuracy in all working positions.
- High contrast vial system is easy to clean and optimises visibility.
- Shock absorbing end caps protect the frame.
- Overmolded, non-slip grips stick to the wall and prevent sliding.
- Durable, all-metal hang hole for storage.
- Accurate to 0.029° (0.0005 ʹ in, 0.5 mm/ m) in normal and reverse position.
- Amplified rare earth magnets for maximum holding power (only magnetic levels).



Strong and durable frame, reinforced BACKBONE™



SHARPSITE™ vial technology improves the readability of the vial

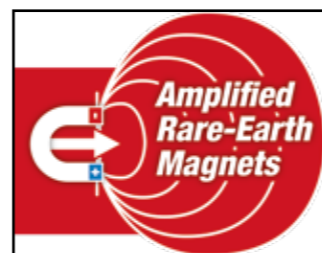

Amplified rare earth magnets for maximum holding power (only magnetic levels)



Description	Length (cm)	Handles	Pack quantity	Min. order quantity	Article Number	EAN Code
40 cm magnetic	40	0	1	1	4932459061	4002395280322
60 cm magnetic	60	0	1	1	4932459063	4002395280346
80 cm magnetic	80	1	1	1	4932459065	4002395280360
100 cm magnetic	100	0	1	1	4932459067	4002395280384
120 cm magnetic	120	2	1	1	4932459069	4002395281008
180 cm magnetic	180	2	1	1	4932459071	4002395281046
200 cm magnetic	200	2	1	1	4932459073	4002395281060
240 cm magnetic	240	2	1	1	4932459075	4002395281084
40 cm non-magnetic	40	0	1	1	4932459060	4002395280315
60 cm non-magnetic	60	0	1	1	4932459062	4002395280339
80 cm non-magnetic	80	1	1	1	4932459064	4002395280353
100 cm non-magnetic	100	0	1	1	4932459066	4002395280377
120 cm non-magnetic	120	2	1	1	4932459068	4002395280391
180 cm non-magnetic	180	2	1	1	4932459070	4002395281015
200 cm non-magnetic	200	2	1	1	4932459072	4002395281053
240 cm non-magnetic	240	2	1	1	4932459074	4002395281077
End-caps for REDSTICK™ BACKBONE™ levels			2	1	4932459680	4058546028527

REDSTICK™ compact box levels



- SHARPSITE™ vial technology improves the readability of the vial.
- Compact and durable frame.
- Bottom milled measuring surface provides maximum accuracy.
- High contrast vial system is easy to clean and optimises visibility.
- Amplified rare earth magnets for maximum holding power (only magnetic levels).
- Accurate to 0.029° (0.0005 ʹ in, 0.5 mm/ m) in standard position.
- Shock absorbing rubber end caps.



Description	Length (cm)	Handles	Pack quantity	Min. order quantity	Article Number	EAN Code
40 cm magnetic	40	0	1	1	4932459079	4002395281725
60 cm magnetic	60	0	1	1	4932459081	4002395281749
80 cm magnetic	80	0	1	1	4932459083	4002395281763
100 cm magnetic	100	0	1	1	4932459085	4002395281787
120 cm magnetic	120	0	1	1	4932459087	4002395282401
180 cm magnetic	180	0	1	1	4932459089	4002395282425
40 cm non-magnetic	40	0	1	1	4932459078	4002395281718
60 cm non-magnetic	60	0	1	1	4932459080	4002395281732
80 cm non-magnetic	80	0	1	1	4932459082	4002395281756
100 cm non-magnetic	100	0	1	1	4932459084	4002395281770
120 cm non-magnetic	120	0	1	1	4932459086	4002395281794
180 cm non-magnetic	180	0	1	1	4932459088	4002395282418
End-caps for REDSTICK™ compact levels			2	1	4932459681	4058546028534

Slim box levels



- 2 solid acrylic vials. Shockproof and UV resistant.
- Precision milled measuring surface up to 120 cm provides maximum accuracy.
- Shock absorbing end caps.
- Durable hang hole for storage.
- VPA third party certificate on accuracy.
- Accurate to 0.029° (0.0005 ʹ in, 0.5 mm/ m) in standard position.



Description	Length (cm)	Pack quantity	Min. order quantity	Article Number	EAN Code
20 cm magnetic	20	1	10	4932478897	4058546361792
40 cm magnetic	40	1	1	4932464854	4058546227999
60 cm magnetic	60	1	1	4932464855	4058546228002
100 cm magnetic	100	1	1	4932464856	4058546228019
180 cm magnetic	180	1	1	4932464857	4058546228026
20 cm non-magnetic	20	1	10	4932472091	4058546324872
40 cm non-magnetic	40	1	1	4932459090	4002395282432
60 cm non-magnetic	60	1	1	4932459091	4002395282449
80 cm non-magnetic	80	1	1	4932459092	4002395282456
100 cm non-magnetic	100	1	1	4932459093	4002395282463
120 cm non-magnetic	120	1	1	4932459094	4002395282470
180 cm non-magnetic	180	1	1	4932459095	4002395282487
200 cm non-magnetic	200	1	1	4932459590	4058546027629



I-beam levels



- Lightweight reinforced aluminium frame.
- Magnetic edge allows hands free use when working with metal.
- Accurate to 0.029° (0.0005 7/ in, 0.5 mm/ m) in normal and reverse position.
- Pitch vial for easy reading of 1 and 2 degree pitch.
- High contrast vial surrounds for maximised visibility.
- Shock absorbing end caps.



Description	Length (cm)	Handles	Pack quantity	Min. order quantity	Article Number	EAN Code
I-Beam level magnetic - 60 cm	60	1	1	1	4932478565	4058546347581
I-Beam level magnetic - 120 cm	120	2	1	1	4932478566	4058546347598
I-Beam level magnetic - 200 cm	200	2	1	1	4932478567	4058546347604

Block torpedo level



- SHARPSITE™ vial technology improves the readability of the vial.
- Locking 360° adjustable vial. Identify and repeat any angle needed on the jobsite. Lock vial in place to keep accuracy in and out of pocket/ pouch.
- Amplified rare earth magnets for maximum holding power.
- Reinforced plumb vials. Solid, acrylic block vials offer maximum durability.
- Die cast aluminium body withstands the conditions of the jobsite.
- Precision milled measuring surface provides maximum accuracy.
- Lanyard hole for use with all most prevention programs.
- Accurate to 0.029° (0.0005 7/ in, 0.5 mm/ m).



Description	Length (cm)	Pack quantity	Min. order quantity	Article Number	EAN Code
Block torpedo level	25	1	1	4932459096	4002395282494

REDCAST die-cast levels



- 2 solid acrylic vials. Shockproof and UV resistant.
- 2 heavy duty cast aluminium „anvil“ strike pads for trowel blows during tile work.
- Drill bit diameter gauge in the level's profile from 5 to 12 mm.
- Precision milled measuring surface provides maximum accuracy.
- Durable hang hole for storage.
- VPA third party certificate on accuracy.
- Accurate to 0.029° (0.0005 7/ in, 0.5 mm/ m).



Description	Length (cm)	Pack quantity	Min. order quantity	Article Number	EAN Code
REDCAST die-cast level 60 cm	60	1	1	4932459098	4002395283118
REDCAST die-cast level 80 cm	80	1	1	4932459099	4002395283125

Billet torpedo level



- Amplified rare earth magnets for maximum holding power.
- Maximised viewing area. Easily read slope in 1/8" or 1/4" per foot in either direction.
- Reinforced acrylic vials offer maximum durability.
- Weld clearance. Easily level over weld joints in pipes and other materials.
- Optimised V-groove design for stability on non-ferrous pipes.
- Laser etched ruled edge for quick measurements on material.
- Slim, tapered design for easy sliding in and out of pockets and pouches.



Description	Length (cm)	Pack quantity	Min. order quantity	Article Number	EAN Code
Billet torpedo level	17	1	1	4932459097	4002395283101

LED Torpedo Level

- 2 x LED-integrated Hi-vis spirit vials ensure perfect readability in poor lighting conditions.
- High contrast vial surrounds increase vial visibility.
- Amplified rare earth magnets for maximum holding power.
- Optimized V-groove working edge for stability on pipes and conduits.
- Durable aluminum frame for the conditions on the job site.
- Slim, tapered design for easy sliding in and out of pockets and pouches.
- Accurate to 0.029° (0.0005 7/ in, 0.5 mm/ m).



Description	Length (cm)	LED	Magnetic	Pack quantity	Min. order quantity	Article Number	EAN Code
LED Torpedo Level	23	Yes	3 - Rare earth magnets	1	1	4932498742	4058546526115

Base Torpedo Level

- High contrast vial surrounds increase vial visibility.
- 3 x Hi-vis fluid vials provide improved readability and accuracy.
- Amplified rare earth magnets for maximum holding power.
- Optimized V-groove working edge for stability on pipes and conduits.
- Durable aluminum frame for the conditions on the job site.
- Slim, tapered design for easy sliding in and out of pockets and pouches.
- Accurate to 0.029° (0.0005 7/ in, 0.5 mm/ m).



Description	Length (cm)	Magnetic	Pack quantity	Min. order quantity	Article Number	EAN Code
Base Torpedo Level	25	3 - Rare earth magnets	1	1	4932498716	4058546525859

Pocket level



- 360° adjustable vial for reading angles.
- Locking mechanism for repetitive use in and out of pocket/ pouch.
- Amplified rare-earth magnets for maximum holding power.
- V-groove for leveling on pipes.
- Milled edge to ensure accuracy.
- Compact size for jobsite functionality.



Description	Length (cm)	Pack quantity	Min. order quantity	Article Number	EAN Code
Pocket level	7.8	1	6	4932459597	4058546027698

Compact torpedo



- SHARPSITE™ pitch vial for easy reading of 1 and 2 degree pitch.
- Sub compact design for working in tight spaces.
- Optimized V-groove design for stability of rounded surfaces.
- Weld clearance to level over weld lines in pipe and other material.
- Amplified rare earth magnets for maximum holding power.
- Accurate to 0.029° (0.0005 7/ in, 0.5 mm/ m).



Description	Length (cm)	Pack quantity	Min. order quantity	Article Number	EAN Code
Compact torpedo	7.6	1	1	4932472122	4058546325183

Minibox level



- Lightweight aluminium box profile fits easily into your tool belt or pocket.
- Solid acrylic vial. Shockproof and UV resistant vials.
- Shockproof end caps.
- Accurate to 0.029° (0.0005 7/ in, 0.5 mm/ m) in standard position.
- VPA third party certificate on accuracy.



Description	Length (cm)	Pack quantity	Min. order quantity	Article Number	EAN Code
Minibox level	10	1	10	4932459100	4002395283446

Chalk reel

- Extra bold lines - 2 mm thick line for maximum visibility.
- Planetary gear system for increased durability.
- 4/1 gear ratio for fast line retraction.
- Large chalk capacity.
- Easy refills due to the extra large quick turn opening.
- Easy line securing due to the line lock.



Description	Pack quantity	Min. order quantity	Article Number	EAN Code
① 30 m large capacity chalk reel	1	1	4932471634	4058546295332
② 45 m large capacity chalk reel	1	1	4932471635	4058546295349
③ 30 m replacement line chalk reel	1	1	4932471636	4058546295356
④ 45 m replacement line chalk reel	1	1	4932471637	4058546295363

Fine Line Chalk Reel

- 6:1 retraction ratio for fast line retraction to get the job done faster.
- Planetary gear system for increased durability.
- Flush handle storage prevents handle movement when not in use.
- Line width of 0.9mm for precise work and 30m line length.
- All metal body to protect the tool from the toughest jobsite conditions.
- Low spillage line for minimal chalk spill which reduces the clean up time.



Description	Colour	Min. order quantity	Pack quantity	Article Number	EAN Code
① Fine Line Chalk Reel & Blue Chalk Refill	Blue	1	2	4932493814	4058546509743
② Fine Line Chalk Reel & Red Chalk Refill	Red	1	2	4932498390	4058546522599

Bold Line Chalk Reel

- 6:1 retraction ratio for fast line retraction to get the job done faster.
- Planetary gear system for increased durability.
- Flush handle storage prevents handle movement when not in use.
- Line width of 1.5mm for clear visibility and 30m line length.
- Rubber overmold on the housing for improved grip and to protect from toughest jobsite conditions.



Description	Colour	Min. order quantity	Pack quantity	Article Number	EAN Code
① Bold Line Chalk Reel & Blue Chalk Refill	Blue	1	2	4932493815	4058546509750
② Bold Line Chalk Reel & Red Chalk Refill	Red	1	2	4932498391	4058546522605

Framing Square

- Reinforced, thick aluminum frame designed for superior durability.
- Laser etched markings provide superior visibility.
- Precision scribe notches for easy marking.
- Anodized surface coating protects from jobsite wear and corrosion.
- Common conversion table.
- Markings to assist in angle finding.



Description	Length (cm)	length (Inch)	Pack quantity	Min. order quantity	Article Number	EAN Code
Framing Square Metric	20 x 30	-	1	1	4932498718	4058546525873
Framing Square Imperial	40 x 60	-	1	1	4932472126	4058546325220
		16 x 24	1	1	4932472125	4058546325213

Rafter Square

- Precision scribe notches for easy marking.
- High visibility laser etched markings.
- Pipe prop to assist in cutting pipe materials.
- Increased heel width for improved grip.



Description	Length (cm)	length (Inch)	Pack quantity	Min. order quantity	Article Number	EAN Code
Rafter Square Metric	18	-	1	1	4932472124	4058546325206
	30	-	1	1	4932498717	4058546525866
Rafter Square Imperial	-	7	1	1	4932472123	4058546325190



INKZALL™ markers

- Stays sharp, doesn't mushroom or push back under pressure.
- Acrylic nib ideal for rough surfaces such as OSB and concrete.
- Marker continues to write after 72+ hours of cap off time.
- For use on concrete, wood, metal, plywood, OSB, plastic.
- Can be used on wet, oily, dusty, rusty, with debris surfaces.
- Quick dry time – reduced smearing markings on PVC, metal surfaces.
- Thin body for use in restricted areas.
- Helmet clip – can be clipped to the construction site cap, trousers, overalls.
- Easy open cap for one hand operation.
- Anti-Roll design - won't roll off surfaces.

Description	Colour	Tip	Pack quantity	Min. order quantity	Article Number	EAN Code
① INKZALL™ marker*	Black	1 mm	1	36	48223100	045242319473
② INKZALL™ marker*	Red	1 mm	1	36	48223170	045242355259
③ INKZALL™ marker*	Blue	1mm	1	36	4932492126	4058546414931
④ INKZALL™ marker	Green	1mm	1	36	4932492127	4058546414948
⑤ INKZALL™ marker with stylus	Black	1 mm	1	1	48223101	045242297436
⑥ INKZALL™ fine tip markers	Black	0.6 mm	4	1	48223154	045242479764
⑦ INKZALL™ colour markers Blue, Red, Green, Black		1 mm	4	1	48223106	045242333585
⑧ INKZALL™ chisel point marker	Black	1- 4,8 mm	1	1	48223103	045242333608

* Orders are only possible in master cartons (contains 36 x 48223100). Minum order quantity is 36 pcs (= 1 master carton). Order quantities greater than 36 pcs are to be ordered in multiples of 36 pcs (i.e. 72, 108, 144, 180...).

INKZALL™ chisel tip markers

- Marker continues to write after 72+ hours of cap off time.
- Can be used on wet, oily, dusty, rusty, with debris surfaces.
- For use on concrete, wood, metal, plywood, OSB, plastic.
- Quick dry time – reduced smearing markings on PVC, metal surfaces.
- Easier to read from a distance due to the increased chisel tip sizes.

Description	Colour	Tip	Pack quantity	Min. order quantity	Article Number	EAN Code
① INKZALL™ black chisel tip marker L (3 pc)	Black	6.2 mm	3	1	4932471554	4058546294533
② INKZALL™ black chisel tip marker L	Black	6.2 mm	1	12	4932471555	4058546294540
③ INKZALL™ red chisel tip marker L	Red	6.2 mm	1	12	4932471556	4058546294557
④ INKZALL™ blue chisel tip marker L	Blue	6.2 mm	1	12	4932471557	4058546294564
⑤ INKZALL™ black chisel tip marker XL (1 pack)	Black	14.5 mm	1	1	4932471558	4058546294571
⑥ INKZALL™ black chisel tip marker XL	Black	14.5 mm	1	12	4932471559	4058546294588
⑦ INKZALL™ red chisel tip marker XL	Red	14.5 mm	1	12	4932471560	4058546294595
⑧ INKZALL™ blue chisel tip marker XL	Blue	14.5 mm	1	12	4932471561	4058546294601



INKZALL™ liquid paint markers

- Valve action marker.
- Durable acrylic nib for the most demanding environmental conditions: surface temperature from -10° up to + 145°.
- Marks on dark surfaces where traditional markers would not be easily visible.
- Can be used on rough, dirty and greasy surfaces.
- For use on concrete, black pipe, aluminium, PVC, steel & stainless steel, rubber and tyres.
- 10 seconds dry time.
- Water and UV resistant markings.
- Permanent markers. Markings last up to 6 months.
- Metal barrel for construction site durability.
- Xylene-free paint.
- IMPORTANT: Shake the marker with the cap on. Remove the cap and carefully pump it up and down until ink flows into the nib.



Description	Colour	Pack quantity	Min. order quantity	Article Number	EAN Code
① INKZALL™ liquid paint marker	Yellow	1	12	48223721	045242363377
② INKZALL™ liquid paint marker	White	1	12	48223711	045242363360
③ INKZALL™ liquid paint marker	Black	1	12	48223731	045242363384
④ INKZALL™ liquid paint marker	Blue	1	12	4932492144	4058546415112
⑤ INKZALL™ liquid paint marker	Red	1	12	4932492143	4058546415105



INKZALL™ highlighters

- Durable tip stays sharp longer.
- No smearing, doesn't bleed through.
- Non-toxic ink, ASTM D 4236 certification.
- Ideal for architectural drawings, labels, office paper.
- Anti-roll body design for better grip on smooth surfaces.
- Construction helmet clip: the INKZALL™ highlighters can be clipped to the helmet, trousers, overalls, etc.
- Lanyard hole, e.g. to attach the INKZALL™ highlighters to the belt.

Description	Pack quantity	Min. order quantity	Article Number	EAN Code
① INKZALL™ highlighter - yellow	5	1	48223201	045242482573
② INKZALL™ highlighter - coloured	5	1	48223206	045242482580



INKZALL™ fine tip pens

- Approx. 0.6 mm tip.
- Clog resistant.
- Main applications: marking of labels for electrical wires, adding comments to architect plans.

Description	Colour	Pack quantity	Min. order quantity	Article Number	EAN Code
① INKZALL™ fine tip pens (4 pc) - black	Black	4	1	48223164	045242479818
② INKZALL™ fine tip pens (4 pc) - coloured	Black, Red, Blue	4	1	48223165	045242479825



INKAZLL™ Deep Reach Ultra-Fine Point

NEW

- Deep Reach Design - for markings in hard-to-reach areas such as drilled holes and electrical boxes.
- Acrylic nib ideal for rough surfaces such as OSB and concrete.
- Quick dry time – reduced smearing markings on PVC, metal surfaces.
- Marker continues to write after 72+ hours of cap off time.



Description	Pack quantity	Min. order quantity	Article Number	EAN Code
INKAZLL™ Deep Reach Ultra-Fine Point	1	1	4932501147	4058546624491

INKZALL™ Double Tips

NEW

- 2 in 1 marking for quick & easy switch between two tip types without changing markers & saving space in pocket/toolbag as fewer tools are needed.
- Durable marker tip that writes on concrete, OSB & rough jobsite surfaces.
- Quick dry time – reduced smearing markings on PVC, metal surfaces.
- Marker continues to write after 72+ hours of cap off time.



Description	Colour	Tip	Pack quantity	Min. order quantity	Article Number	EAN Code
INKZAL™ Double Tip – Chiseled/Fine Point	Black	Chiseled & Fine Point	1	1	4932501155	4058546624576
INKZAL™ Double Tip - Ultra-Fine Point/Fine Point	Black	Ultra-Fine Point/Fine Point	1	1	4932501154	4058546624569

CUTTING HAND TOOLS



FASTBACK™ flip utility knife

- Integrated gut hook. Allows users to make cuts without exposing the blade.
- Tool free blade change. Less down time in the field for blade changes.
- Wire stripper. Eliminates the need to look for another tool in user's bag.
- Thin body design. Tool is easily stored in user's pocket.
- Belt clip for easy storage.



Description	Pack quantity	Min. order quantity	Article Number	EAN Code
① FASTBACK™ compact flip utility knife	1	1	4932471356	4058546289843
② FASTBACK™ flip utility knife	1	6	4932471357	4058546289850
③ FASTBACK™ flip utility knife with blade storage	1	1	4932471358	4058546289867

FASTBACK™ 5 in 1 folding knife

- Stainless steel blade.
- Liner lock secures the blade in the open position.
- Partially serrated for versatility making it easier to both pierce and tear through material.
- The folding knife includes a fold-out 1/4" bit holder along with a reversible PH2 and slotted bit.
- Built-in bottle opener for added functionality.
- Durable belt clip that reduces pocket tearing.
- Lanyard hole for easy attachment to the Milwaukee safety range to allow use at heights.



Description	Pack quantity	Min. order quantity	Article Number	EAN Code
FASTBACK™ 5 in 1 folding knife	1	1	4932492454	4058546418212

FASTBACK™ 6 in 1 utility knife

- 1/4" Hex bit holder with double ended PH2 and SL5.5. Tool free blade change. Less down time in the field for blade changes.
- Wire stripper. Eliminates the need to look for another tool in user's bag.
- Belt clip for easy storage.
- Integrated bottle opener.



Description	Pack quantity	Min. order quantity	Article Number	EAN Code
FASTBACK™ 6 in 1 utility knife	1	1	4932478559	4058546347529

FASTBACK™ folding knife

- Resharpenable stainless steel blade.
- Piercing tip allows controlled piercing and smooth cutting.
- Liner lock secures the blade in the open position.
- Lanyard hole.
- Wire form belt clip for quick access without fraying pockets.



Description	Pack quantity	Min. order quantity	Article Number	EAN Code
① FASTBACK™ folding knife	1	1	48221990	045242296842
② FASTBACK™ Camo folding knife	1	1	4932492375	4058546417420

Compact pocket knife

- Compact size for carrying in the pocket.
- Resharpenable stainless steel blade.
- Piercing tip allows controlled piercing and smooth cutting.
- Liner lock secures the blade in the open position.
- Lanyard hole.



Description	Pack quantity	Min. order quantity	Article Number	EAN Code
① Compact pocket knife	1	1	4932478560	4058546347536
② Compact Pocket Knife Counter Display	1	10	4932492661	4058546414115

Fixed blade knife

- The fixed blade knife is designed for optimal edge retention and durability.
- 4" (101mm) stainless steel blade, optimised to stay sharper longer.
- Full metal tang provides durability for tough cut.
- Ergonomic handle offers secure and comfortable grip.
- Lanyard hole for easy tethering.
- Durable moulded sheath with belt clip for fast access.



Description	Pack quantity	Min. order quantity	Article Number	EAN Code
Fixed blade knife	1	1	4932464828	4058546227739

Hawkbill fixed blade knife

- The hawkbill fixed blade knife is ideal for stripping wire and cable.
- Stainless steel blade is optimised to stay sharper longer.
- Full metal tang provides durability for tough cuts.
- Large ergonomic handle designed for comfortable use with gloves.
- Lanyard hole for easy tethering.
- Durable molded sheath with belt clip for fast access.



Description	Pack quantity	Min. order quantity	Article Number	EAN Code
Hawkbill fixed blade knife	1	1	4932464829	4058546227746

HARDLINE™ folding knives

- Premium D2 blade steel provides better corrosion resistance. High strength and wear resistance, stays sharp longer.
- Smooth / serrated blade and piercing tip. Ideal for tearing through material and tip allows controlled piercing.
- Flip opening with bearing system: can be opened with 1 hand only.
- Opening steel frame lock secures the blade in the open position.
- Glass filled nylon handle with stainless steel.
- Liner lock secures the blade in the open position.
- Lanyard hole for easy attachment to the Milwaukee safety range to allow use at heights.
- Reversible belt clip allows right or left handed carry.



Description	Blade type	Pack quantity	Min. order quantity	Article Number	EAN Code
① HARDLINE™ Folding Knife 75mm - Smooth	Smooth	1	1	48221994	045242477043
② HARDLINE™ Folding Knife 75mm - Serrated	Serrated	1	1	48221998	045242359165
③ HARDLINE™ Folding Knife 64mm - Smooth	Smooth	1	1	4932492452	4058546418199
④ HARDLINE™ Folding Knife 89mm - Smooth	Smooth	1	1	4932492453	4058546418205

HARDLINE™ fixed blade knife

- 5" (127 mm) AUS-8 Steel blade allows the blade to hold its edge longer, reducing the user's need to sharpen.
- Full metal tang provides durability for tough cuts.
- Overmolded handle for a strong secure grip, and a lanyard hole.
- Durable multi position sheath for flexible carry option and fast access.



Description	Pack quantity	Min. order quantity	Article Number	EAN Code
HARDLINE™ fixed blade knife	1	1	4932464830	4058546227753

Fixed blade utility knife

- Ready to use fixed blade for an easier and fastest access to the knife.
- Tool-free blade change: Saves time changing blades. Thumb-screw mechanism allows to change the blade quickly and without any extra tools.
- Blade storage holds up to 5 blades conveniently inside the handle.
- Tool lanyard hole for easy tethering.
- Heavy Duty: Durable full metal body.



Description	Pack quantity	Min. order quantity	Article Number	EAN Code
Fixed blade utility knife	1	1	4932471361	4058546289898

Sliding utility knife

- Side slide mechanism to reduce the risk of exposing the blade accidentally.
- Full metal body with rubber overmold for increased durability, comfort and reduced hand slippage.
- Tool free blade change saves time when changing blades.
- Onboard blade storage for 5 extra blades.
- Lanyard hole for easy attachment to the Milwaukee safety range to allow use at heights.



Description	Pack quantity	Min. order quantity	Article Number	EAN Code
① Compact sliding utility knife	1	1	4932492379	4058546417468
② Sliding utility knife	1	1	4932492378	4058546417451

Self-retracting safety knife

- Self-retract mechanism: Retracts blade when the button is released. Blade storage holds up to 5 blades conveniently inside the handle.
- Tool-free blade change: Saves time changing blades. Thumb-screw mechanism allows to change the blade quickly and without any extra tools.
- Heavy Duty: Durable full metal body.



Description	Pack quantity	Min. order quantity	Article Number	EAN Code
Self-retracting safety knife	1	1	4932471360	4058546289881

Mini Flush Cutters

- Angled head design for better access to tight spaces.
- Induction hardened cutting edges for consistent, precise cuts through thin wires and cable ties.
- Spring loaded handle for maximum efficiency and to reduce hand fatigue while using the tool.
- Rust protection increases tool life by reducing corrosion.
- Ergonomic handle designed with comfort grips that will not peel.



Description	Pack quantity	Min. order quantity	Article Number	EAN Code
Mini Flush Cutters	1	1	4932499024	4058546528935

General purpose utility blades

- Iron carbide deposited metal for longer lifetime.
- Optimised cutting angle geometry for sharpness.
- Extra ground cutting edge for cleaner cuts.
- Blades are protected and easily accessible from storage box.

Description	Total length (mm)	Height (mm)	Pack quantity	Min. order quantity	Article Number	EAN Code
① General purpose utility knife blades	62	19	50	1	48221950	045242344444
② Hook utility knife blades	62	19	50	1	48221905	045242268061
③ Carton utility knife blades (rounded)	62	19	5	1	48221934	045242286942



Snap knives

- Metal lock* for maximum durability and longer lifetime.
- Lock with a speed thread* that allows faster blade adjustment.
- Auto-lock slide** for faster blade adjustment.
- Snap-off cap pocket clip** snaps off blade segments.
- Overmolded handle offers a slip resistant grip and is an acetone resistant.
- Iron carbide blade for longer lifetime, increased sharpness and clean cut finish.

Description	Blade width (mm)	No. blade points	Pack quantity	Min. order quantity	Article Number	EAN Code
① Snap knife 9 mm	9	13	1	1	48221960	045242296811
② Snap knife 18 mm	18	8	1	1	48221961	045242296798
③ Snap knife 25 mm	25	7	1	1	48221962	045242296828

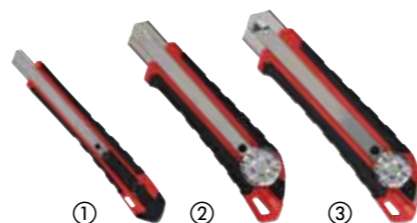

Snap blades

- Robust re-usable storage dispenser with easy access to blades.
- Optimized cutting angle geometry for sharpness and improved cutting precision.
- Iron carbide metal for longer life.
- Precise ground cutting edges for cleaner cuts.

Description	Blade width (mm)	No. blade points	Pack quantity	Min. order quantity	Article Number	EAN Code
① Snap blades 9 mm	9	13	10	1	4932480106	4058546403911
② Snap blades 18 mm	18	8	10	1	4932480107	4058546403928
③ Snap blades 25 mm	25	7	10	1	4932480108	4058546403935

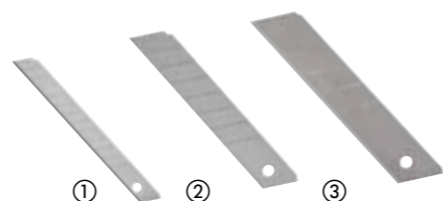

Compact knife sharpener

- Three sharpening styles for heavier, lighter and serrated blade sharpening.
- Finger loop hole for easier holding and more control.
- A magnet for convenient storage.
- High contrast ID markings in the front and back for easier readability.
- Versatile use for knives and scissors.
- Lanyard hole for easy attachment to the Milwaukee safety range to allow use at heights.

Description	Pack quantity	Min. order quantity	Article Number	EAN Code
Compact knife sharpener	1	6	4932478562	4058546347550



PVC saw

- All-metal handle design for best-in-class durability.
- Tool free blade change: up to 10x faster blade change.
- Overmold handle for increased comfort.
- Compact design.

Description	Pack quantity	Min. order quantity	Article Number	EAN Code
PVC saw	1	1	4932500075	4058546572396
PVC saw replacement blade	1	1	4932500042	4058546572068



Compact hacksaw

- Tool free blade change for changing blades up to 10x faster.
- Compact design, ideal for versatile cutting in tight spaces.
- Adjustable blade length for easier flush cutting.
- Rubber overmold grip for increased comfort.
- Accepts 12" blades.
- Supplied with 10" / 24 Tpi blade.

Description	Pack quantity	Min. order quantity	Article Number	EAN Code
Compact hacksaw	1	1	4932500041	4058546572051



Folding jab saw

- Enlarged handle end for easier and comfortable plunging.
- Accepts all 150mm SAWZALL™ blades and is compatible with all SAWZALL™ reciprocating saw blades.
- Tool free blade change.
- Folding blade for easier and safer storage.
- Supplied with a 8 TPI, 150 mm blade.
- Lanyard hole for easy attachment to the Milwaukee safety range to allow use at heights.

Description	Blade length (mm)	Pack quantity	Min. order quantity	Article Number	EAN Code
Folding jab saw	150	1	1	4932492812	4058546476830



Hacksaw

- Tough metal frame, supports higher tension (25,000 PSI / 250 lbs).
- Overmould handle ensures secure grip and user comfort.
- Internal blade storage for extra blades.
- Supplied with 12" / 24 Tpi blade.

Description	Pack quantity	Min. order quantity	Article Number	EAN Code
Hacksaw	1	1	48220050	045242362226
Hacksaw replacement blades	10	5	4932493923	4058546510831



Rasping job saw

- 150 mm plaster / drywall blade: Extra strong thicker blade making it more resistant for plunge cuts.
- Coated for corrosion protection.
- Built in rasping holes: Allows user to rapidly expand holes or smooth rough edges.



Description	Pack quantity	Min. order quantity	Article Number	EAN Code
① Rasping job saw	1	1	4932479783	4058546375775
② Drywall kit (2pc)	2	1	4932479784	4058546375782

Jobsite scissors

- Iron carbide cutting edge for maximum durability. Longer lifetime vs. stainless steel.
- Chrome plated blades for maximum rust protection.
- All metal core: Full metal handle construction to protect from drops and handle breakage.
- Bolt lock technology protects blades from loosening to ensure precise cutting.
- Large handle loops for use with gloves.
- Index finger groove for more comfort.
- Laser edged ruler markings on the blade allows to measure and cut in one go.
- Jobsite offset scissors with micro-serrated blades for maximum durability and better grip.
- Jobsite offset scissors with 60°-offset head allows to keep hand above cutting material.



Description	Total length (mm)	Blade length (mm)	Weight (g)	Pack quantity	Min. order quantity	Article Number	EAN Code
① Straight scissors	230	95	180	1	1	4932479409	4058546372033
② Offset scissors	240	115	230	1	1	4932479410	4058546372040

Electricians Scissors

- Cable cutting groove for greater leverage.
- Rounded groove allows for easy wire stripping.
- Cable crimper for crimps up to 6 mm.
- Adjustable tightening screw allows to set desired resistance.
- Tool holder with belt strap for easy storage.



Description	Pack quantity	Min. order quantity	Article Number	EAN Code
Electricians Scissors	1	1	4932478620	4058546348137

Aviation Snips

- Thumb and forefinger slots for increased comfort and less fatigue. Allows user to push through sheet metal with ease with less risk of cutting oneself.
- Serrated cutting edges prevent slippage when cutting.
- Less hand fatigue when cutting thicker materials. Design with compound leverage action.
- Torsion spring opens jaws automatically during cutting for faster cutting action and less fatigue work.
- Chrome plated rust protected forged blades for increased lifetime. Extra hardened to 65 HRC.
- Made from forged alloy steel for best durability – Cr Steel.
- One hand locking mechanism.
- Flush slimline design for non-snagging in material.
- Triple cutting direction identification – on the head, handle and by colour coded handle.
- Ergonomic and durable overmoulded grips add comfort and last longer.
- Aviation snips: For short, straight and shaped cuts. Ideal for narrow radius cuts and notch cuts.
- Offset snips: For long continuous straight or curved cuts. 45° offset keeps users hand away from the cutting material.
- Extra long aviation snips: For longer and straighter cuts in one go.

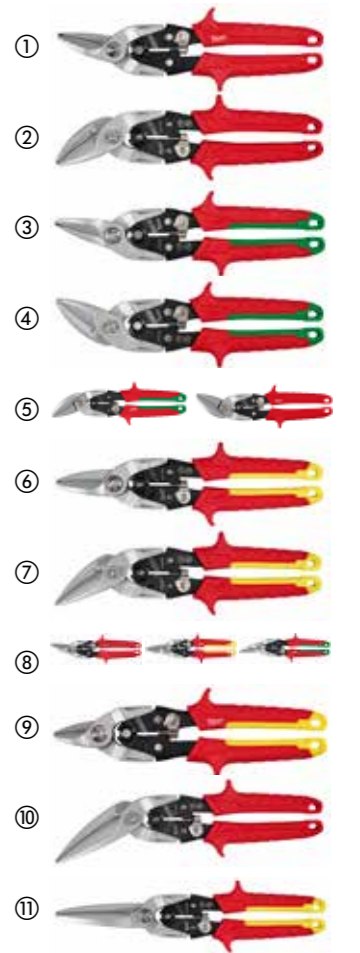

Description	Colour code	Pack quantity	Min. order quantity	Article Number	EAN Code
① Left Cutting Aviation Snips	Red	1	1	4932499011	4058546528805
② Left Cutting Offset Aviation Snips	Red	1	1	4932499013	4058546528829
③ Right Cutting Aviation Snips	Green	1	1	4932499014	4058546528836
④ Right Cutting Offset Aviation Snips	Green	1	1	4932499016	4058546528850
⑤ 2 pc Offset Aviation Snip Set	-	2	1	4932499017	4058546528867
⑥ Straight Cutting Aviation Snips	Yellow	1	1	4932499018	4058546528874
⑦ Straight Cutting Offset Aviation Snips	Yellow	1	1	4932499019	4058546528881
⑧ 3 pc Aviation Snip Set	-	3	1	4932499020	4058546528898
⑨ Bulldog Aviation Snips	Yellow	1	1	4932499010	4058546528799
⑩ Long Cut Offset Left Aviation Snips	Yellow	1	1	4932499022	4058546528911
⑪ Long Straight Aviation Snips	Yellow	1	1	4932499021	4058546528904



Mini copper tubing cutters

- Proprietary adjustment mechanism.
- Chrome rollers for added durability and extended performance provide best in class rust protection.
- Easy grip knob allows faster adjustment and easier one handed use.
- Compact design to cut pipes in restricted areas.



Description	Max. cutting capacity in copper pipe (mm)	Pack quantity	Min. order quantity	Article Number	EAN Code
Mini copper tubing cutter 15 mm	3 - 15	1	1	48229250	045242521210
Mini copper tubing cutter 22 mm	3 - 22	1	1	48229258	045242521258
Mini copper tubing cutter 28 mm	3 - 28	1	1	48229251	045242521227



Constant swing copper tubing cutters

- Constant swing copper tubing cutters are engineered for straighter, cleaner cuts.
- 4 roller design delivers accurate cuts and prevents walking.
- Chrome rollers for added durability and extended performance provide best in class rust protection.
- Smooth adjustment mechanism.
- On-board reamer enables fast, easy deburring.
- A spare wheel is integrated in the knob.



Description	Max. cutting capacity in copper pipe (mm)	Pack quantity	Min. order quantity	Article Number	EAN Code
Constant swing copper tubing cutter 29 mm	3 - 28	1	1	4932500077	4058546572419
Constant swing copper tubing cutter 42 mm	3 - 42	1	1	4932500078	4058546572426
Constant swing copper tubing cutter 67 mm	16 - 67	1	1	48229253	045242521241
Reaming blades		3	1	48224257	045242356263

Constant Swing Inox Tubing Cutter

NEW

- Constant swing inox tubing cutters are engineered for straighter, cleaner cuts.
- 4 roller design delivers accurate cuts and prevents walking.
- Chrome rollers for added durability and extended performance provide rust protection.
- Smooth adjustment mechanism.
- On-board reamer enables fast and easy deburring.
- A spare wheel is integrated in the knob.



Description	Max. cutting capacity inox (mm)	Pack quantity	Min. order quantity	Article Number	EAN Code
Constant Swing Inox Tubing Cutter 29mm	3 - 29	1	1	4932499088	4058546529574
Constant Swing Inox Tubing Cutter 42mm	3 - 42	1	1	4932499089	4058546529581

Tubing cutter blades

- Replacement blades for tubing cutters.



Description	Pack quantity	Min. order quantity	Article Number	EAN Code
Tubing cutter blades for copper	2	1	48224256	045242356256

Reaming pen

- Provides easy deburring of copper tubing and PVC.
- All-metal design for durability through demanding jobsite use.
- Heat treated and black oxide coated blade for extended life.
- A slide resistant clip allows easy storage in the users pocket or tool bag for quick access.



Description	Pack quantity	Min. order quantity	Article Number	EAN Code
Reaming pen	1	1	48224255	045242356249

Inner-Outer Deburrer

- 40 hardened and ground cutting edges provides a clean, burr free, installation-ready pipe.
- Robust aluminium metal housing delivers highest durability for toughest jobsite condition.
- Ridges on the outside for an improved grip, even with gloves.
- Increased versatility in reaming all standard pipe materials. Plastic, copper, aluminium, steel, iron, brass, stainless steel.



Description	Min. order quantity	Pack quantity	Article Number	EAN Code
Inner-Outer Deburrer 6 - 35mm	1	1	4932493812	4058546509729
Inner-Outer Deburrer 10 - 54mm	1	1	4932493813	4058546509736

Plastic cutter

- Cuts PEX, PB, MDP, PE, plastic electrical conduits, pneumatic pipe, plastic overflow pipe, rubber hoses, silicon hoses up to Ø 25 mm.
- V-shaped blade allows quick and straight cuts; prevents crushing of material.
- Replaceable stainless steel blade.
- Robust construction: Metal core from the head to the handles for maximum lifetime.
- One handed locking mechanism, tool remains closed while in pouch, spring loaded but easy opening.
- Corrosion resistant head.



Description	Max. capacity tube & pipe (mm)	Pack quantity	Min. order quantity	Article Number	EAN Code
Plastic Cutter	25	1	1	4932479407	4058546372019
Plastic cutter blade replacement	-	1	1	4932479408	4058546372026

Ratcheting PVC cutter

- Durable stainless steel rust proof blade for more cuts.
- Comfortable handle adds working comfort.
- Quick blade release adds working speed.
- One-handed metal lock.
- Lanyard hole, improves working security.
- Blades are replaceable.
- Suitable for: PVC, CPVC, PEX, PP, PB, PVDF, PE.



Description	Max. capacity tube & pipe (mm)	Pack quantity	Min. order quantity	Article Number	EAN Code
① Ratcheting PVC cutter 42 mm	42	1	1	4932464172	4058546221171
① Ratcheting PVC cutter 60 mm	63	1	1	4932464173	4058546221188
② Ratcheting PVC cutter blade 42 mm		1	1	4932500046	4058546572105
② Ratcheting PVC cutter blade 60 mm		1	1	4932500047	4058546572112



Cable cutter

- Best-in-class cut quality: Beveled jaw heads for accurate, smooth cable shearing.
- Comfort grips: More comfortable than dipped plastic. Grips will not peel.
- Forged design: Tool durability in abusive environments.
- Rust protection: Black oxide finish protects from rust.



Description	Pack quantity	Min. order quantity	Article Number	EAN Code
Cable cutter	1	1	48226104	045242356140

Bolt cutters

- Forged steel blades for strong and durable cutting edge.
- Comfort grip handles will not peel or slide off.
- Blade adjustment screw ensures high performance and longer life.
- Lanyard holes.



Description]	Blade width (mm)	Cutting capacity for HRC 31 materials (Max. Ø mm)	Cutting capacity for HRC 48 materials (Max. Ø mm)]	Pack quantity	Min. order quantity	Article Number	EAN Code
14" bolt cutter	13	8	5	1	1	4932464827	4058546227722
24" bolt cutter	13	11	8	1	1	4932464826	4058546227715

Extendable Bolt Cutters

- POWERMOVE™ handles extend for easier cuts in tough applications.
- Forged steel blades for strong and durable cutting edge.
- Pivoting head for angle adjustment.
- Comfort grip handles will not peel or slide off.



Description	Blade width (mm)	Cutting capacity for HRC 31 materials (Max. Ø mm)	Cutting capacity for HRC 48 materials (Max. Ø mm)	Pack quantity	Min. order quantity	Article Number	EAN Code
14" / 18" extendable bolt cutter	13	8	5	1	1	4932464850	4058546227951
24" / 30" extendable bolt cutter	13	11	8	1	1	4932464851	4058546227968

Metric straight flute plug taps

NEW

- Precision machined for creating and repairing clean, accurate threads.
- Long lasting laser etch for the clear markings.
- Black oxide coating for corrosion resistance and high carbon steel for durability.
- Straight flute tap style designed for the most common threading applications.



Description	Pack quantity	Min. order quantity	Article Number	EAN Code
M8-1.00 mm Straight flute plug tap	1	1	4932500595	4058546618971
M5-0.80 mm Straight flute plug tap	1	1	4932500591	4058546618933
M6-1.00 mm Straight flute plug tap	1	1	4932500592	4058546618940
M7-1.00 mm Straight flute plug tap	1	1	4932500593	4058546618957
M8-1.25 mm Straight flute plug tap	1	1	4932500594	4058546618964
M3-0.60 mm Straight flute plug tap	1	1	4932500586	4058546618889
M3-0.50 mm Straight flute plug tap	1	1	4932500587	4058546618896
M4-0.70 mm Straight flute plug tap	1	1	4932500588	4058546618902
M4-0.75 mm Straight flute plug tap	1	1	4932500589	4058546618919
M5-0.90 mm Straight flute plug tap	1	1	4932500590	4058546618926
M9-1.25 mm Straight flute plug tap	1	1	4932500596	4058546618988
M9-1.00 mm Straight flute plug tap	1	1	4932500597	4058546618995
M10-1.50 mm Straight flute plug tap	1	1	4932500598	4058546619008
M10-1.25 mm Straight flute plug tap	1	1	4932500599	4058546619015
M10-1.00 mm Straight flute plug tap	1	1	4932500600	4058546619022
M11-1.50 mm Straight flute plug tap	1	1	4932500601	4058546619039
M12-1.75 mm Straight flute plug tap	1	1	4932500602	4058546619046
M12-1.50 mm Straight flute plug tap	1	1	4932500603	4058546619053
M12-1.25 mm Straight flute plug tap	1	1	4932500604	4058546619060
M14-1.50 mm Straight flute plug tap	1	1	4932500605	4058546619077
M14-1.25 mm Straight flute plug tap	1	1	4932500606	4058546619084
M14-2.0 mm Straight flute plug tap	1	1	4932500607	4058546619091

Metric hex threading dies

NEW

- Precision machined for creating and repairing clean, accurate threads.
- Long lasting laser etch for clearer markings.
- Black oxide coating for corrosion resistance and high carbon steel for durability.
- Clearly labeled starting side for easier threading application set up.



Description	Pack quantity	Min. order quantity	Article Number	EAN Code
M3-0.60 mm Hex threading die	1	1	4932500608	4058546619107
M3-0.50 mm Hex threading die	1	1	4932500609	4058546619114
M4-0.70 mm Hex threading die	1	1	4932500610	4058546619121
M4-0.75 mm Hex threading die	1	1	4932500611	4058546619138
M5-0.90 mm Hex threading die	1	1	4932500612	4058546619145
M5-0.80 mm Hex threading die	1	1	4932500613	4058546619152
M6-1.00 mm Hex threading die	1	1	4932500614	4058546619169
M7-1.00 mm Hex threading die	1	1	4932500615	4058546619176
M9-1.25 mm Hex threading die	1	1	4932500618	4058546619206
M9-1.00 mm Hex threading die	1	1	4932500619	4058546619213
M10-1.50 mm Hex threading die	1	1	4932500620	4058546619220
M10-1.25 mm Hex threading die	1	1	4932500621	4058546619237
M11-1.50 mm Hex threading die	1	1	4932500623	4058546619251
M12-1.75 mm Hex threading die	1	1	4932500624	4058546619268
M12-1.50 mm Hex threading die	1	1	4932500625	4058546619275
M8-1.25 mm Hex threading die	1	1	4932500616	4058546619183
M8-1.00 mm Hex threading die	1	1	4932500617	4058546619190
M10-1.00 mm Hex threading die	1	1	4932500622	4058546619244
M12-1.25 mm Hex threading die	1	1	4932500626	4058546619282
M14-1.50 mm Hex threading die	1	1	4932500627	4058546619299

Tap collet

NEW

- Hex-head design is compatible with Hex-LOK™ 2-in-1 threading handle.
- T-Handle bar slides in or out allowing for tight space threading.
- Forward jaw holds tap sizes up to 1/4".



Description	Pack quantity	Min. order quantity	Article Number	EAN Code
Tap collet for taps & t-handle bar	2	1	4932500628	4058546619305

Hex-LOK™ 2-in-1 Handle & t-bar & tap collet set

NEW

- Hex-LOK™ 2-in-1 Handle offers controlled and smooth threading.
- Hex-LOK™ 2-in-1 Handle is compatible with 1" hex dies & MILWAUKEE® tap collet.
- The tap collet's recessed jaw holds tap sizes 1/4"– 1/2", while the forward jaw holds tap sizes up to 1/4".



Description	Pack quantity	Min. order quantity	Article Number	EAN Code
3pc Hex-LOK™ 2-in-1 handle & T-bar & tap collet Set	3	1	4932500629	4058546619312

Metric thread pitch gauge

NEW

- Precision made leaves for accurate thread measuring.
- 16 leaves for a variety of thread measurements.
- Ideal for checking thread measurements before cutting threads.



Description	Pack quantity	Min. order quantity	Article Number	EAN Code
0.35-3.00 mm Metric thread pitch gauge	1	1	4932500630	4058546619329

Hex-LOK™ 2-in-1 handle

NEW

- Hex-LOK™ 2-in-1 handle is the most versatile threading solution designed for tap and die threading.
- Hex-LOK™ 2-in-1 handle is compatible with 1" hex dies & MILWAUKEE® tap collet.
- Hex-LOK™ 2-in-1 handle compatibility allows for easy snap in and out, tool-free die and collet changes.



Description	Pack quantity	Min. order quantity	Article Number	EAN Code
Hex-LOK 2-in-1 tap and die threading handle	1	1	4932500631	4058546619336

Metric straight flute plug tap & drill bit sets

NEW

- Precision machined for creating and repairing clean, accurate threads.
- Long lasting laser etch for the clearer markings.
- THUNDERWEB design of the drill bits is characterised by a conical shaped web which gets thicker towards the back of the drill bit.
- Straight flute tap style designed for the most common threading applications.



Description	Pack quantity	Min. order quantity	Article Number	EAN Code
2pc M3-0.5mm Plug tap & 2.5mm drill bit set	2	1	4932500634	4058546619367
2pc M4-0.7mm Plug tap & 3.3mm drill bit set	2	1	4932500635	4058546619374
2pc M5-0.8mm Plug tap & 4.2mm drill bit set	2	1	4932500636	4058546619381
2pc M6-1.0mm Plug tap & 5.0mm drill bit set	2	1	4932500637	4058546619398
2pc M8-1.25mm Plug tap & 7.0mm drill bit set	2	1	4932500638	4058546619404
2pc M10-1.5mm Plug tap & 8.5mm drill bit set	2	1	4932500639	4058546619411
2pc M12-1.75mm Plug tap & 10.2mm drill bit set	2	1	4932500640	4058546619428
2pc M14-2.0mm Plug tap & 12.0mm drill bit set	2	1	4932500641	4058546619435

PACKOUT™ Tap and Die Set

- Hex-LOK™ 2-in-1 Handle is a versatile threading solution designed for tap and die threading.
- Hex-LOK™ 2-in-1 Handle is compatible with 1" hex dies & MILWAUKEE® Tap Collet.
- Hex-LOK™ 2-in-1 Handle compatibility allows for easy snap in and out, tool-free die and collet changes.
- Includes precision machined threading accessories and handles for the most common applications.
- Designed for use in metal materials including mild steel, brass and aluminum.
- High carbon chromium bearing steel for durability.
- Black Oxide coated taps and dies for corrosion resistance.
- Taps and dies feature long lasting laser etch for the clearest markings.



Description	Pack quantity	Min. order quantity	Article Number	EAN Code
38 pc Metric Tap & Die Packout™ Set w/ Hex-LOK™ 2-in-1 Handle				
Flute Plug Taps M3-0.50 mm, M4-0.70 mm, M4-0.75 mm, M5-0.80 mm, M5-0.90 mm, M6-1.00 mm, M7-1.00 mm, M8-1.00 mm, M8-1.25mm, M9-1.00 mm, M9-1.25 mm, M10-1.25 mm, M10-1.50mm, M11-1.50 mm, M12-1.50 mm, M12-1.75 mm / 1" Hex Threading Dies M3-0.50 mm, M4-0.70 mm, M5-0.80 mm, M5-0.90 mm, M6-1.00 mm, M7-1.00 mm, M8-1.00 mm, M8-1.25mm, M9-1.25 mm, M10-1.25 mm, M10-1.50mm, M11-1.50 mm, M12-1.50 mm, M12-1.75 mm / Tap Collet / Sliding T-Handle / 0.35-3.00 mm Metric Thread Pitch Gauge / Hex-LOK™ 2-in-1 Handle	38	1	4932498721	4058546525903

17pc Tap and die metric set

NEW

- Includes precision machined threading accessories and handles for the most common applications.
- THUNDERWEB design of the drill bits is characterised by a conical shaped web which gets thicker towards the back of the drill bit. Standard drill bits have a constant thickness throughout their length. Even at the narrowest point the THUNDERWEB core is thicker than that of a standard drill bit.
- Taps and dies are made of high carbon chromium bearing steel for durability.
- Designed for use in metal materials including mild steel, brass and aluminum.
- Black Oxide coated taps and dies for corrosion resistance.
- Taps and dies feature long lasting laser etch for the clearest markings.

①



Description	Pack quantity	Min. order quantity	Article Number	EAN Code
① 17PC Tap and Die Metric Set	17	1		
Flute Plug Taps M3-0.50 mm, M4-0.70 mm, M5-0.80 mm, M6-1.00 mm, M8, 1.25 mm / 1" Hex Threading Dies M3-0.50 mm, M4-0.70 mm, M5-0.80 mm, M6-1.00 mm, M8, 1.25 mm / Drill Bits 2.5 mm, 3.3 mm, 4.2 mm, 5.0 mm, 6.8 mm / T-Handle / 1" Hex Die Stock			4932498720	4058546525897

STRIKING & DEMOLITION HAND TOOLS



Nail Puller

- Dimpler allows for easy nail removal with limited damage to surface.
- Low profile claw to reach the tightest of nails.
- Handle grip greatly reduces vibration.

Description	Length (cm)	Pack quantity	Min. order quantity	Article Number	EAN Code
9" nail puller	22.86	1	1	4932478249	4058546344269
10" nail puller	25.40	1	1	4932478250	4058546344276
12" nail puller	30.48	1	1	4932478251	4058546344283



Trim Puller

- Low profile trim claw to easily slide between trim/ skirting boards and walls.
- Dimpler allows for easy nail removal with limited damage to surface.
- Handle grip greatly reduces vibration.

Description	Length (cm)	Pack quantity	Min. order quantity	Article Number	EAN Code
10" trim puller	25.40	1	1	4932478252	4058546344290



Wrecking Bar

- Beveled edge improves leverage and accessibility when pulling nails, lifting or prying.
- Nail/ staple puller easily removes nails and staples without damaging flooring or surrounding materials.
- Reinforced strikable tongue for extra material penetration using a hammer.

Description	Length (cm)	Pack quantity	Min. order quantity	Article Number	EAN Code
12" wrecking bar	30.48	1	1	4932478253	4058546344306
15" wrecking bar	38.1	1	1	4932478254	4058546344313
21" wrecking bar	53.3	1	1	4932492778	4058546476496



I-Beam Wrecking Bar

NEW

- Durable 450 mm long I-Beam design provides a high strength-to-weight ratio, delivering strong leverage with less weight.
- I-Beam Design makes it easier to hold by giving fingers more to grip and helping prevent slipping.
- Integrated nail notch and the beveled slot on the sharp claw enable versatile nail removal with high leverage.

Length (cm)	Pack quantity	Min. order quantity	Article Number	EAN Code
45	1	1	4932500678	4058546619800



Molding Pry Bar

NEW

- 63 mm wide trim claw to easily slide between trim/ skirting boards and walls.
- Smoothpull dimpler for easy removal of nails driven deep into wood.
- Overall length of 400 mm provides higher leverage.
- Optimized handle design features an ergonomic rubber overmold grip to prevent slipping for maximum comfort and control.
- Handle grip provides shock absorption and greatly reduces vibration.

Length (cm)	Pack quantity	Min. order quantity	Article Number	EAN Code
40	1	1	4932500677	4058546619794



Steel RIP claw hammer

- Shockshield grip reduces peak vibration.
- Straight/RIP claw for prying and demolition work.
- Magnetic nail starter for safer application.
- Side nail puller.
- I-Beam handle construction resists bending in prying applications.
- Precise balance for better handling.



Description	Pack quantity	Min. order quantity	Article Number	EAN Code
16oz Steel RIP claw hammer	1	1	4932478653	4058546348465
20oz Steel RIP claw hammer	1	1	4932478654	4058546348472

Steel curved claw hammer

- Shockshield grip reduces peak vibration.
- Curved claw hammer reduces damage when pulling nails.
- Magnetic nail starter for safer application.
- Side nail puller.
- I-Beam handle construction resists bending in prying applications.
- Precise balance for better handling.



Description	Pack quantity	Min. order quantity	Article Number	EAN Code
16oz Steel curved claw hammer	1	1	4932478655	4058546348489
20oz Steel curved claw hammer	1	1	4932478656	4058546348496

Fiberglass curved claw hammer

- Reinforced fiberglass handle
- Over moulded handle for increased grip and reduced vibration
- Curved claw hammer reduces damage when pulling nails
- Magnetic nail starter for safer application
- Precise balance for better handling



Description	Pack quantity	Min. order quantity	Article Number	EAN Code
16oz Fiberglass curved claw hammer	1	1	4932478657	4058546348502
20oz Fiberglass curved claw hammer	1	1	4932478658	4058546348519

Hickory curved claw hammer

- Hickory handle providing low vibration
- Curved claw hammer reduces damage when pulling nails
- Magnetic nail starter for safer application
- Precise balance for better handling



Description	Pack quantity	Min. order quantity	Article Number	EAN Code
16oz Hickory curved claw hammer	1	1	4932478659	4058546348526
20oz Hickory curved claw hammer	1	1	4932478660	4058546348533

Fiberglass engineers hammer

- Reinforced fiberglass handle
- Over moulded handle for increased grip and reduced vibration
- Reinforced head connection for added durability
- Precise balance for better handling
- DIN 1041



Description	Pack quantity	Min. order quantity	Article Number	EAN Code
200g Fiberglass engineers hammer	1	1	4932478661	4058546348540
300g Fiberglass engineers hammer	1	1	4932478662	4058546348557
500g Fiberglass engineers hammer	1	1	4932478663	4058546348564
800g Fiberglass engineers hammer	1	1	4932478664	4058546348571
1000g Fiberglass engineers hammer	1	1	4932478665	4058546348588

Hickory engineers hammer

- Hickory handle providing low vibration
- Reinforced head connection for added durability
- Precise balance for better handling
- DIN 1041



Description	Pack quantity	Min. order quantity	Article Number	EAN Code
200g Hickory engineers hammer	1	1	4932478666	4058546348595
300g Hickory engineers hammer	1	1	4932478667	4058546348601
500g Hickory engineers hammer	1	1	4932478668	4058546348618
800g Hickory engineers hammer	1	1	4932478669	4058546348625
1000g Hickory engineers hammer	1	1	4932478670	4058546348632

Fiberglass Cross-Peen Hammer

- Longer handle for controlled strikes and additional power.
- Reinforced overstrike protection for more support at the most common failure point.
- High strength fiberglass core provides increased durability and power.
- Overmold handle for increased grip and reduced vibration.
- Lanyard hole for easy attachment to the Milwaukee safety range to allow use at heights.



Description	Pack quantity	Min. order quantity	Article Number	EAN Code
1.13kg / 2.5 lbs Fiberglass Cross-Peen Hammer	1	1	4932498306	4058546521752
1.81kg / 4 lbs Fiberglass Cross-Peen Hammer	1	1	4932498308	4058546521776

Fiberglass Sledge Hammer

- Longer handle for controlled strikes and additional power.
- Reinforced overstrike protection for more support at the most common failure point.
- High strength fiberglass core provides increased durability and power.
- Overmold handle for increased grip and reduced vibration.
- Lanyard hole for easy attachment to the Milwaukee safety range to allow use at heights.



Description	Pack quantity	Min. order quantity	Article Number	EAN Code
1.13kg / 2.5 lbs Fiberglass Sledge Hammer	1	1	4932498305	4058546521745
1.81kg / 4 lbs Fiberglass Sledge Hammer	1	1	4932498307	4058546521769

Club hammer

- **Duel Face Versatility:** Milled face provides additional grip and minimizes movement of face when striking chisels or large nails, the smooth face prevents damage to struck objects.
- **Reinforced Overstrike Protection:** Increases durability in the most common failure point.
- **Fiberglass handle with over molded grip:** Provides durability with improved grip capacity and comfort.
- **Lanyard Hole:** Easily comply with safety regulations working at height.



Description	Pack quantity	Min. order quantity	Article Number	EAN Code
1.36 kg / 3 lbs club hammer	1	1	4932478255	4058546344320
0.91 kg / 2 lbs Club Hammer	1	1	4932498304	4058546521738

Steel ball peen hammer

- **SHOCKSHIELD™ grip** reduces peak vibration.
- **Precise balance** for better handling and control.
- **I-Beam handle construction** resists bending.
- **Strong steel head** prevents chipping on contact.
- **Durable grip handle** with an anti-slip design.



Description	Weight (g)	Weight (oz)	Pack quantity	Min. order quantity	Article Number	EAN Code
450g Ball peen hammer	450	16	1	1	4932492346	4058546417130
680g Ball peen hammer	680	24	1	1	4932492347	4058546417147

Dead blow ball peen hammer

- **Precision balanced design** and steel shot-filled head for optimised control.
- **Durable metal faces** preventing chipping on contact.
- **Steel reinforced handle** for higher durability.
- **Over molded handle** for more control and better grip.



Description	Weight (g)	Weight (oz)	Pack quantity	Min. order quantity	Article Number	EAN Code
450g Dead blow ball peen hammer	450	16	1	1	4932492348	4058546417154
907g Dead blow ball peen hammer	907	32	1	1	4932492349	4058546417161

Dead blow hammer

- **Steel shot-filled head** for increased rebound reduction and maximised impact.
- **High-performance cover** preventing damage to surfaces.
- **Precision balanced design** and over molded handle for more control and better grip.
- **Steel reinforced handle** for higher durability.



Description	Weight (g)	Weight (oz)	Pack quantity	Min. order quantity	Article Number	EAN Code
790g Dead blow hammer	790	28	1	1	4932492350	4058546417178
1360g Dead blow hammer	1360	48	1	1	4932492351	4058546417185

Roofing Hammer

NEW

- **Forged from one single piece** for highest durability & long life; Increased strength through elimination of weak points.
- **Reduces peak vibration & increased comfort** and grip through ergonomic design.
- **Fast and easy nail placement;** for one handed operations & reduced risk of damaging fingers



Description	Pack quantity	Min. order quantity	Article Number	EAN Code
Roofing Hammer 750g	1	1	4932493655	4058546485269

Beveled Edge Chisels

- **All metal core** for maximum durability.
- **Metal striking cap** for a longer handle life.
- **Permanent size markings** on the blade and handle for quick identification.
- **Blade storage** for safe transportation or storage.



Description	Pack quantity	Min. order quantity	Article Number	EAN Code
Beveled Edge Chisel 6mm	1	1	4932479892	4058546376864
Beveled Edge Chisel 12mm	1	1	4932479893	4058546376871
Beveled Edge Chisel 19mm	1	1	4932479894	4058546376888
Beveled Edge Chisel 25mm	1	1	4932479895	4058546376895
① Beveled Edge Chisel 32mm	1	1	4932479896	4058546376901
② Beveled Edge Chisel Set 4pc 6mm, 12mm, 19mm, 25mm	4	1	4932479897	4058546376918



Pry bar

- I-Beam design for added durability.
- All-metal core for improved durability.
- Hammer-ready strike cap improves leverage when working in tight spaces.
- Comfortable Tri-Lobe handles for better grip.
- All-chrome shafts for increased durability.
- Curved claw design reduces damage when pulling nails.

Description	Pack quantity	Min. order quantity	Article Number	EAN Code
① 200mm Pry bar	1	1	4932480595	4058546408800
② 300mm Pry bar	1	1	4932480596	4058546408817
③ 450mm Pry bar	1	1	4932480597	4058546408824
④ 600mm Pry bar	1	1	4932480598	4058546408831
⑤ 900mm Pry bar	1	1	4932480599	4058546408848
⑥ 1000mm Pry bar	1	1	4932480600	4058546408855
⑦ Pry bar set - 4 pcs 200 mm - 300 mm - 450 mm - 600 mm	4	1	4932501195	4058546639112

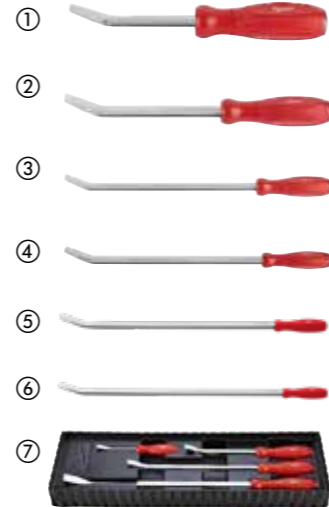

Hook & pick sets

- All-metal core for long-lasting durability and rust protection.
- Chrome-plated shanks reduce corrosion and provide rust protection.
- Comfort grip handle and precision knurling increase tool control and user comfort.
- Supplied in an easy-access storage tray for long-term tool storage.

Description	Pack quantity	Min. order quantity	Article Number	EAN Code
① Hose Pick - Flat Tip	1	1	4932480570	4058546408558
② Hose Pick - Hook	1	1	4932480571	4058546408565
③ Hose Pick - Bent 90 Degree	1	1	4932480572	4058546408572
④ Hose Pick - Bent 45 Degree	1	1	4932480573	4058546408589
⑤ Hook & pick set offset pick, straight pick, hook, 90° pick	4	1	48229215	045242508105
⑥ Heavy Duty Hook & Pick Set (4 pc) HD Flat hose pick, HD 90° hose pick, HD 45° hose pick, HD Hook hose pick, Storage tray	4	1	4932480568	4058546408534
⑦ Hook & Pick Set (8 pc) HD Flat hose pick, HD 90° hose pick, HD 45° hose pick, HD Hook hose pick, Straight pick, Offset hook, Hook, 90°hook, Storage tray	8	1	4932480569	4058546408541



SCREWDRIVERS + ELECTRICIAN HAND TOOLS



Hex key wrenches with comfort grip

- T-STRIKE™ provides a striking cap for protection to the tool itself and better access to rounded or rusted bolts, while having an all-metal core for extra-durability.
- Hex ball end on the long side allows 30° access to any hex screw.
- Quick and easy size identification with markings on the tool and on the storage holder.
- Burnished tips for a precise fit.

Size (mm)	Total length (mm)	Pack quantity	Min. order quantity	Article Number	EAN Code
2	144	1	1	4932498678	4058546525477
2.5	144	1	1	4932498679	4058546525484
3	205	1	1	4932498680	4058546525491
3.5	205	1	1	4932498681	4058546525507
4	205	1	1	4932498682	4058546525514
4.5	205	1	1	4932498683	4058546525521
5	205	1	1	4932498684	4058546525538
6	266	1	1	4932498685	4058546525545
7	266	1	1	4932498686	4058546525552
8	266	1	1	4932498687	4058546525569
10	266	1	1	4932498688	4058546525576



NEW

Torx Key Wrenches with Comfort Grip Set

- T-STRIKE™ provides a striking cap for protection to the tool itself and better access to rounded or rusted bolts, while having an all-metal core for extra-durability.
- Short end has a Torx tip for more durability and long side tamper-proof Torx for security screws.
- Quick and easy size identification with markings on the tool and on the storage holder.
- Magnetic storage tray with pre-drilled holes for best and easy organization in the workshop.

Description	Pack quantity	Min. order quantity	Article Number	EAN Code
7pc Torx key wrenches with comfort grip set with rack	7	1	4932498690	4058546525590
T9, T10, T15, T20, T25, T30, T40 and rack				



NEW

Hex Key Wrenches with Comfort Grip Set

- T-STRIKE™ provides a striking cap for protection to the tool itself and better access to rounded or rusted bolts, while having an all-metal core for extra-durability.
- Hex ball end on the long side allows 30° access to any hex screw.
- Quick and easy size identification with markings on the tool and on the storage holder.
- Magnetic storage tray with pre-drilled holes for best and easy organization in the workshop.

Description	Pack quantity	Min. order quantity	Article Number	EAN Code
7pc Hex key wrenches with comfort grip set with rack	7	1	4932498677	4058546525460
2mm, 2.5mm, 3mm, 4mm, 5mm, 6mm, 8mm and Storage rack				



NEW

Nut driver with t-handle grip

- T-STRIKE™ provides a striking cap for protection to the tool itself and better access to rounded or rusted bolts, while having an all-metal core for extra-durability.
- Short end has a deep hex socket for more durability and on the long side deep 12-point socket for better access in hard-to-reach spots.
- Deep sockets to work on bolts with long threads.
- Quick and easy size identification with markings on the tool and on the storage holder.

Size (mm)	Total length (mm)	Pack quantity	Min. order quantity	Article Number	EAN Code
5	180	1	1	4932498705	4058546525743
5.5	180	1	1	4932498706	4058546525750
6	200	1	1	4932498707	4058546525767
7	200	1	1	4932498708	4058546525774
8	220	1	1	4932498709	4058546525781
9	220	1	1	4932498710	4058546525798
10	236	1	1	4932498711	4058546525804
11	236	1	1	4932498712	4058546525811
12	255	1	1	4932498713	4058546525828
13	255	1	1	4932498714	4058546525835
14	275	1	1	4932498715	4058546525842



NEW

Torx key wrenches with comfort grip

- T-STRIKE™ provides a striking cap for protection to the tool itself and better access to rounded or rusted bolts, while having an all-metal core for extra-durability.
- Short end has a Torx tip for more durability and long side tamper-proof Torx for security screws.
- Quick and easy size identification with markings on the tool and on the storage holder.
- Burnished tips for a precise fit.

Size (mm)	Total length (mm)	Pack quantity	Min. order quantity	Article Number	EAN Code
T6	144	1	1	4932498691	4058546525606
T7	144	1	1	4932498692	4058546525613
T8	144	1	1	4932498693	4058546525620
T9	144	1	1	4932498694	4058546525637
T10	144	1	1	4932498695	4058546525644
T15	205	1	1	4932498696	4058546525651
T20	205	1	1	4932498697	4058546525668
T25	205	1	1	4932498698	4058546525675
T27	205	1	1	4932498699	4058546525682
T30	205	1	1	4932498700	4058546525699
T40	266	1	1	4932498701	4058546525705
T45	266	1	1	4932498702	4058546525712
T50	266	1	1	4932498703	4058546525729



NEW

Nut driver wrenches with comfort grip set

- T-STRIKE™ provides a striking cap for protection to the tool itself and better access to rounded or rusted bolts, while having an all-metal core for extra-durability.
- Short end has a deep hex socket for more durability and on the long side deep 12-point socket for better access in hard-to-reach spots.
- Deep sockets to work on bolts with long threads.
- Quick and easy size identification with markings on the tool and on the storage holder.
- Magnetic storage tray with pre-drilled holes for best and easy organization in the workshop.

Description	Pack quantity	Min. order quantity	Article Number	EAN Code
7pc Nut driver with comfort grip set with rack	7	1	4932498704	4058546525736
5mm, 6mm, 7mm, 8mm, 10mm, 12mm, 13mm and rack				



NEW

L-Form hex key sets

- Twist and lock case for easy access to keys.
- Ball end for up to 30° access to screw.
- Size identification to easily identify the key.
- Lanyard hole for easy attachment to the Milwaukee lanyard range allowing use at height.

Description	Length (mm)	Pack quantity	Min. order quantity	Article Number	EAN Code
① Hex Keys 1.5, 2, 2.5, 3, 4, 5, 6, 8, 10mm	-	9	1	4932478621	4058546348144
Hex Key - 1.5mm	91.5	1	1	4932492409	4058546417765
Hex Key - 2mm	102	1	1	4932492410	4058546417772
Hex Key - 2.5mm	114.5	1	1	4932492411	4058546417789
Hex Key - 3mm	129	1	1	4932492412	4058546417796
Hex Key - 4mm	144	1	1	4932492413	4058546417802
Hex Key - 5mm	165	1	1	4932492414	4058546417819
Hex Key - 6mm	186	1	1	4932492415	4058546417826
Hex Key - 8mm	208	1	1	4932492416	4058546417833
Hex Key - 10mm	234	1	1	4932492417	4058546417840
② Compact Hex Key 9pc Set 1.5, 2, 2.5, 3, 4, 5, 6, 8, 10mm	-	9	1	4932492399	4058546417666
Compact Hex Key - 1.5mm	46.5	1	1	4932492400	4058546417673
Compact Hex Key - 2mm	52	1	1	4932492401	4058546417680
Compact Hex Key - 2.5mm	58.5	1	1	4932492402	4058546417697
Compact Hex Key - 3mm	66	1	1	4932492403	4058546417703
Compact Hex Key - 4mm	74	1	1	4932492404	4058546417710
Compact Hex Key - 5mm	85	1	1	4932492405	4058546417727
Compact Hex Key - 6mm	96	1	1	4932492406	4058546417734
Compact Hex Key - 8mm	108	1	1	4932492407	4058546417741
Compact Hex Key - 10mm	122	1	1	4932492408	4058546417758

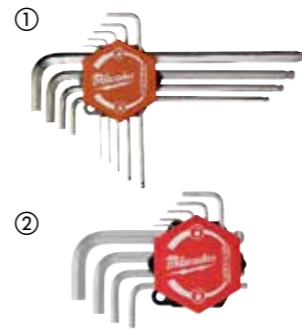

L-form hex key set

- Pivoting key holder for easy access to keys.
- Ball end for up to 30° access to screw.
- High contrast size markings to easily identify the key.
- Easy key ID with lasting laser etched markings.
- Offset slots for quick key access.

Description	Pack quantity	Min. order quantity	Article Number	EAN Code
13pc Imperial L-form hex key set	13	1	4932493615	4058546484866

3/16", 1/4", 5/16", 3/8", 7/16", 1/2", 5/8", 3/4", 7/8", 1", 1 1/8", 1 1/4", 1 1/2", 1 3/4", 2", 2 1/4", 2 1/2", 3", 3 1/2", 4", 4 1/2", 5", 5 1/2", 6", 6 1/2", 7", 7 1/2", 8", 9", 10"



Folding Key Sets

- Foldable keys enable easy access & storage solution
- High contrast size callouts for quick and easy identification
- Ergonomically handle provides comfortable and secure grip
- Metal housing for increased durability

Description	Length (mm)	Pack quantity	Min. order quantity	Article Number	EAN Code
① 8pc Metric folding hex key set 1.5mm, 2mm, 2.5mm, 3mm, 4mm, 5mm, 6mm, 8mm	118	8	1	4932480978	4058546412630
② 8pc Folding Torx key set T9, T10, T15, T20, T25, T27, T30, T40	118	8	1	4932480979	4058546412647
③ 9pc Imperial folding hex key set <i>3/16", 1/4", 5/16", 3/8", 7/16", 1/2", 5/8", 3/4", 7/8", 1", 1 1/8", 1 1/4", 1 1/2", 1 3/4", 2", 2 1/4", 2 1/2", 3", 3 1/2", 4", 4 1/2", 5", 5 1/2", 6", 6 1/2", 7", 7 1/2", 8", 9", 10"</i>	116	9	1	4932493614	4058546484859



L-Form torx key set

- Unique patented twist and lock function case to allow easy access to keys.
- Torx ball end allows for 25° access to any torx screw.
- Size labels directly at the keys for easy and quick identification of the tool.
- Long keys for extra reach in hard-to-reach spaces.
- Lanyard hole for easy attachment to the Milwaukee safety range to allow use at heights.

Description	Length (mm)	Pack quantity	Min. order quantity	Article Number	EAN Code
① 9 PC L-Form Torx Key Set T8, T9, T10, T15, T20, T25, T27, T30, T40	-	9	1	4932492693	4058546475642
Torx Key - T8	91.5	1	1	4932492694	4058546475659
Torx Key - T9	102	1	1	4932492695	4058546475666
Torx Key - T10	114.5	1	1	4932492696	4058546475673
Torx Key - T15	129	1	1	4932492697	4058546475680
Torx Key - T20	144	1	1	4932492698	4058546475697
Torx Key - T25	165	1	1	4932492699	4058546475703
Torx Key - T27	186	1	1	4932492700	4058546475710
Torx Key - T30	208	1	1	4932492701	4058546475727
Torx Key - T40	234	1	1	4932492702	4058546475734
② 9 PC compact L-form Torx key set T8, T9, T10, T15, T20, T25, T27, T30, T40	-	9	1	4932492703	4058546475741
Compact torx key - T8	46.5	1	1	4932492704	4058546475758
Compact torx key - T9	52	1	1	4932492705	4058546475765
Compact torx key - T10	58.5	1	1	4932492706	4058546475772
Compact torx key - T15	66	1	1	4932492707	4058546475789
Compact torx key - T20	74	1	1	4932492708	4058546475796
Compact torx key - T25	85	1	1	4932492709	4058546475802
Compact torx key - T27	96	1	1	4932492710	4058546475819
Compact torx key - T30	108	1	1	4932492711	4058546475826
Compact torx key - T40	122	1	1	4932492712	4058546475833

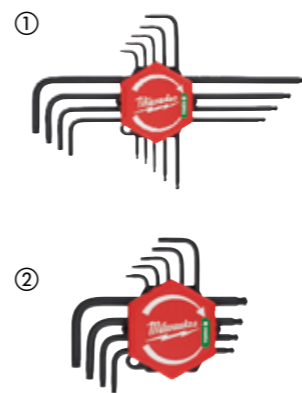

Tri-lobe screwdrivers

- Comfortable Tri-Lobe handle optimized for maximum user comfort and high torque applications.
- Permanent visible ID markings allows for quick tool identification.
- Landyard hole for easy attachment to a safety system.
- Hardened magnetic tips for maximum durability and fastener retention.
- Anti role, 3 sided collar on the handle
- Wrench ready shank allows extra leverage to be applied.

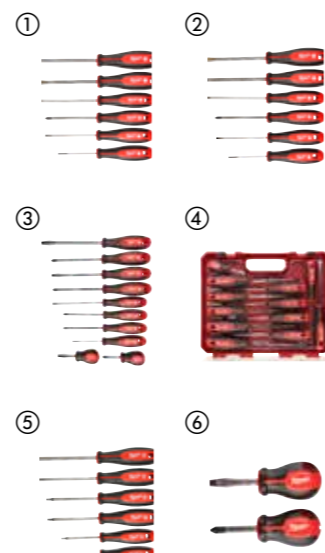

	Description	Shank type	Pack quantity	Min. order quantity	Article Number	EAN Code
Slotted	SL 0.4 x 2 x 65	Round	1	1	4932471773	4058546296728
	SL 0.4 x 2.5 x 75	Round	1	1	4932471774	4058546296735
	SL 0.5 x 3 x 75	Round	1	1	4932471775	4058546296742
	SL 0.5 x 3 x 150	Round	1	1	4932471776	4058546296759
	SL 0.6 x 3.5 x 100	Round	1	1	4932471777	4058546296766
	SL 0.8 x 4 x 100	Round	1	1	4932471778	4058546296773
	SL 1.0 x 5.5 x 125	Round	1	1	4932471779	4058546296780
	SL 1.2 x 6.5 x 45	Wrench ready	1	1	4932471780	4058546296797
	SL 1.2 x 6.5 x 125	Wrench ready	1	1	4932471781	4058546296803
	SL 1.2 x 8 x 150	Wrench ready	1	1	4932471782	4058546296810
SL 1.6 x 8 x 175	Wrench ready	1	1	4932471783	4058546296827	
SL 1.2 x 10 x 200	Wrench ready	1	1	4932471784	4058546296834	
Phillips	PH0 x 75	Wrench ready	1	1	4932471785	4058546296841
	PH1 x 100	Wrench ready	1	1	4932471786	4058546296858
	PH2 x 45	Wrench ready	1	1	4932471787	4058546296865
	PH2 x 125	Wrench ready	1	1	4932471788	4058546296872
	PH3 x 150	Wrench ready	1	1	4932471789	4058546296889
Pozidrive	PZ0 x 75	Wrench ready	1	1	4932471790	4058546296896
	PZ1 x 100	Wrench ready	1	1	4932471791	4058546296902
	PZ2 x 45	Wrench ready	1	1	4932471792	4058546296919
	PZ2 x 125	Wrench ready	1	1	4932471793	4058546296926
	PZ3 x 150	Wrench ready	1	1	4932471794	4058546296933
TORX	T6 x 65	Round	1	1	4932471795	4058546296940
	T7 x 65	Round	1	1	4932471796	4058546296957
	T8 x 65	Round	1	1	4932471797	4058546296964
	T9 x 75	Round	1	1	4932471798	4058546296971
	T10 x 75	Round	1	1	4932471799	4058546296988
	T15 x 75	Round	1	1	4932471800	4058546296995
	T20 x 100	Round	1	1	4932471801	4058546297008
	T25 x 100	Round	1	1	4932471802	4058546297015
	T30 x 125	Round	1	1	4932471803	4058546297022
	T40 x 125	Round	1	1	4932471804	4058546297039

	Description	Pack quantity	Min. order quantity	Article Number	EAN Code
①	Tri-lobe screwdriver set 1 (6 pc) PZ1 / PZ2 / SL3 / SL4 / SL5.5 / SL6.5	6	1	4932471806	4058546297053
②	Tri-lobe screwdriver set 2 (6 pc) PH1 / PH2 / SL3 / SL4 / SL5.5 / SL6.5	6	1	4932471807	4058546297060
③	Tri-lobe screwdriver set 3 (10 pc) PZ1 / PZ2 / PH1 / PH2 / SL3 / SL5.5 / SL6.5 / SL8 / PH2x45 / SL6.5 x 45	10	1	4932471808	4058546297077
④	Tri-lobe screwdriver set 4 (12 pc) PZ0 / PZ1 / PZ2 / PH0 / PH1 / PH2 / SL2.5 / SL4 / SL5.5 / SL6.5 / SL6.5 / SL8	12	1	4932472003	4058546323998
⑤	Tri-lobe screwdriver Torx set (6 pc) T10 / T15 / T20 / T25 / T30 / T40	6	1	4932471809	4058546297084
⑥	Tri-lobe screwdriver stubby set (2 pc) PZ2 x 45mm / SL6.5 x 45mm	2	1	4932471810	4058546297091

Tri-lobe demolition screwdriver

- Hammer ready strike caps.
- All metal core.
- Wrench ready shank.
- Comfortable Tri-Lobe handle.



Description	Pack quantity	Min. order quantity	Article Number	EAN Code
Tri-lobe demolition screwdriver set PH2 / SL7.9 mm	2	1	4932471872	4058546297718

Demolition driver

- Hardened all metal core giving maximum shank durability.
- Multiple striking caps to give user more force when prying and chiseling.



Description	Length (mm)	Pack quantity	Min. order quantity	Article Number	EAN Code
Demo driver	287	1	1	4932480975	4058546412609

Multi-Bit screwdriver

- In-handle bit storage for quick and easy bit access.
- Easy visible when a bit is missing.
- Removable bit holder for access in tighter spaces.
- Power-tool ready bit holder with a 1/4" reception.
- Double-sided bits in the 27 in 1 multi-bit screwdriver for widest range of applications. Laser engraved sizing on the bits for easier identification.

Description	Pack quantity	Min. order quantity	Article Number	EAN Code
① 8 in 1 Compact Multi-Bit Screwdriver PH1 / PH2 / PZ1 / PZ2 / T15 / SL 0.6x4.5 / SL 1.2x6.5	1	6	4932492807	4058546476786
② 14 in 1 Multi-Bit Screwdriver Hex 3 mm / Hex 4 mm / Hex 5 mm / PH1 / PH2 / PZ1 / PZ2 / T10 / T15 / T20 / T25 / SL 0.8x5.5 / SL 1.2x6.5	1	6	4932492806	4058546476779
③ 14 in 1 Torx Multi-Bit Screwdriver PH1 / PH2 / T6 / T7 / T8 / T9 / T10 / T15 / T20 / T25 / T27 / T30 / T40	1	6	4932492810	4058546476816
④ 14 in 1 Shockwave Multi-Bit Screwdriver Hex 3mm/ Hex 4mm/ Hex 5mm/ PH1 / PH2 / PZ1 / PZ2 / T10 / T15 / T20 / T25 / SL 0.8x5.5 / SL 1.2x6.5	1	1	4932498174	4058546520434
⑤ 27 in 1 Multi-Bit Screwdriver Hex 2 mm & Hex 3mm / Hex 2.5mm & Hex 4mm / Hex 5mm & Hex 6mm / PH0 & SL 1.2x6.5 / PH1 & SL 0.6x4.5 / PH2 & SL 0.5x5.0 / PH3 & SL 0.8x5.5 / T10 & T15 / T20 & T30 / PZ1 & T25 / PZ2 & T27 / PZ3 & T40 / Hex 1.5mm & T9	1	6	4932492808	4058546476793

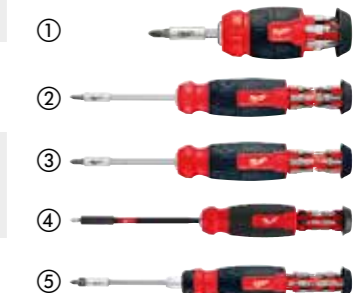

Ratcheting multi-bit screwdriver

- In-handle bit storage for quick and easy bit access.
- Easy visible when a bit is missing.
- Removable bit holder for access in tighter spaces.
- Power-tool ready bit holder with a 1/4" reception.
- Double-sided bits in the 27 in 1 ratchet multi-bit screwdriver for widest range of applications.
- Laser engraved sizing on the bits for easier identification.

Description	Pack quantity	Min. order quantity	Article Number	EAN Code
① 8 in 1 Compact Ratcheting Multi-Bit Screwdriver PH1 / PH2 / PZ1 / PZ2 / T15 / SL 0.6x4.5 / SL 1.2x6.5	1	6	4932480581	4058546408664
② 14 in 1 Ratchet Multi-Bit Screwdriver Hex 3 mm / Hex 4 mm / Hex 5 mm / PH1 / PH2 / PZ1 / PZ2 / T10 / T15 / T20 / T25 / SL 0.8x5.5 / SL 1.2x6.5	1	6	4932480582	4058546408671
③ 27 in 1 Ratchet Multi-Bit Screwdriver Hex 2 mm & Hex 3mm / Hex 2.5mm & Hex 4mm / Hex 5mm & Hex 6mm / PH0 & SL 1.2x6.5 / PH1 & SL 0.6x4.5 / PH2 & SL 0.5x5.0 / PH3 & SL 0.8x5.5 / T10 & T15 / T20 & T30 / PZ1 & T25 / PZ2 & T27 / PZ3 & T40 / Hex 1.5mm & T9	1	6	4932480583	4058546408688
④ 2 pc Ratcheting and Compact Ratcheting Multi-Bit Screwdriver Kit 14 in 1 Ratchet Multi-Bit Screwdriver - 4932480582, 8 in 1 Compact Ratcheting Multi-Bit Screwdriver - 4932480581	1	6	4932492811	4058546476823



8 in 1 compact ratcheting multi-bit screwdriver

- Full metal high torque ratchet for 2x driving speed and control.
- Chrome plated marine grade rust protected bits.
- Revolver style bit storage in handle.
- Precision hardened bit tips: Durable driving tips for secure fitment and long life.

Description	Pack quantity	Min. order quantity	Article Number	EAN Code
8 in 1 compact ratcheting multi-bit screwdriver PH1 / PH2 / PZ1 / PZ2 / T15 / SL4.8 / SL6.4	1	1	4932471868	4058546297671



9 in 1 ratcheting multi-bit screwdriver

- Ergonomic 152 mm long screwdriver with 1/4" Hex nut driver (in reception) and built in loop maker.
- Full metal high torque ratchet for 2x driving speed and control.
- 88 mm long power groove bits, power tool compatibility.
- Precision hardened bit tips: Durable driving tips for secure fitment and long life.
- Revolver style bit storage in handle.
- Chrome plated marine grade rust protected bits.

Description	Pack quantity	Min. order quantity	Article Number	EAN Code
9 in 1 ratchet multi-bit screwdriver - universal PH1 / PH2 / PZ1 / PZ2 / T15 / T20 / Slotted 0.8 x 5.5 mm	1	12	4932471598	4058546294977



Precision Multi-Bit Screwdriver

- 360° rotating back cap, giving greater control for speed and precision and optimised for any kind of maintenance applications.
- On-board bit storage for an easy access to the bits and no carrying case needed.
- Double-sided bits for a quick bit switching.
- Non-slip grip for comfortable handling and maximum control.

Description	Pack quantity	Min. order quantity	Article Number	EAN Code
① 4 in 1 Precision Multi-Bit Screwdriver PH00 & SL 0.23x1.5 / PH0 & SL 0.5x3.0	1	6	4932480584	4058546408695
② 4 in 1 Torx Precision Multi-Bit Screwdriver T B08 & T B015 / T B07 & T B010	1	1	4932498175	4058546520441
27 in 1 Precision Multi-Bit Screwdriver	1	1	4932498176	4058546520458
③ PH0 & PH2 / PH00 & PH1 / PH000 & SL2.5 / SL1 & SL3 / SL2 & H1.3mm / H0.9mm & HT 2.5mm / T4 & H1.5mm / T3 & HT 2mm / T B05 & T B08 / T B07 & T B010 / T B06 & S0 / PL2 & PL5 / Y000 & Y0				



39 in 1 Precision Screwdriver Set

- 360° rotating back cap, giving greater control for speed and precision and optimised for any kind of maintenance applications.
- Supplied in a durable PACKOUT™ compatible case designed to get the bits out easily.
- Dual-length shank providing a compact and a standard size.
- Non-slip grip for comfortable handling and maximum control.

Description	Pack quantity	Min. order quantity	Article Number	EAN Code
39 in 1 Precision Screwdriver Set with Case PH2 / PH1 / PH0 / PH00 / PH000 / SL3.5 / SL3 / SL2.5 / SL2 / SL1.5 / SL1 / SPANNER 6 / SPANNER 4 / SO / HT3.5mm / HT3mm / HT2.5mm / HT2mm / H1.5mm / H1.3mm / H0.9mm / T B015 / T B010 / T B09 / T B08 / T B07 / T B06 / T B05 / T4 / T3 / Y1 / Y0 / Y000 / P5 / P2 / TA3 / TA2 / SQ2 / SQ1	1	1	4932498177	4058546520465



Precision screwdrivers

- All metal core for improved durability.
- 360° rotating back cap.
- Chrome plated shanks increase tool life by reducing corrosion.
- Durable case with robust zipper included to store tools.
- Longer shanks for improved visibility and extended reach.

Description	Pack quantity	Min. order quantity	Article Number	EAN Code
Precision screwdriver set (6 pc) PH00 / PH0, SL1.6 / SL2 / SL3.2 / SL4	6	1	4932471869	4058546297688
Torx precision screwdriver (6 pc) T6, T7, T8, T9, T10, T15	6	1	4932471870	4058546297695



HOLLOWCORE™ Magnetic Nut Drivers

- HOLLOWCORE™ unlimited depth handle for use on long threaded rod while driving and fastening.
- 6 point head for better fit on common fasteners.
- Magnetic retention driver heads for secure fitment in fastening applications.
- Wrench ready hex shank for added leverage.
- Tri-lobe handle delivers more torque during applications.
- Colour coded ID markings allow for quick tool identification on jobsite.



Description	Size (mm)	Colour code	For anchor thread size	Pack quantity	Min. order quantity	Article Number	EAN Code
5mm HOLLOWCORE™ Magnetic Nut Driver	5	Black	-	1	1	4932479884	4058546376789
5.5mm HOLLOWCORE™ Magnetic Nut Driver	5.5	Brown	M3	1	1	4932479885	4058546376796
6mm HOLLOWCORE™ Magnetic Nut Driver	6	Red	M3.5	1	1	4932479886	4058546376802
7mm HOLLOWCORE™ Magnetic Nut Driver	7	Orange	M4	1	1	4932479887	4058546376819
8mm HOLLOWCORE™ Magnetic Nut Driver	8	Yellow	M5	1	1	4932479888	4058546376826
10mm HOLLOWCORE™ Magnetic Nut Driver	10	Blue	M6	1	1	4932479889	4058546376833
13mm HOLLOWCORE™ Magnetic Nut Driver	13	Orange	M8	1	1	4932479890	4058546376840
17mm HOLLOWCORE™ Magnetic Nut Driver	17	Green	M10	1	1	4932498571	4058546524401
HOLLOWCORE™ Magnetic Nut Driver Set - 7 pc	5, 5.5, 6, 7, 8, 10, 13	-	M3 - M8	7	1	4932500080	4058546572440

HOLLOWCORE™ Nut Drivers

- HOLLOWCORE™ unlimited depth handle for use on long threaded rod while driving and fastening.
- 6 point head for better fit on common fasteners. Wrench ready hex shank for added leverage.
- Tri-lobe handle delivers more torque during applications.
- Colour coded ID markings allow for quick tool identification on jobsite.



Description	Size (mm)	Colour code	For anchor thread size	Pack quantity	Min. order quantity	Article Number	EAN Code
5mm HOLLOWCORE™ Nut Driver	5	Black	-	1	1	4932492365	4058546417321
5.5mm HOLLOWCORE™ Nut Driver	5.5	Brown	M3	1	1	4932492366	4058546417338
6mm HOLLOWCORE™ Nut Driver	6	Red	M3.5	1	1	4932492367	4058546417345
7mm HOLLOWCORE™ Nut Driver	7	Orange	M4	1	1	4932492368	4058546417352
8mm HOLLOWCORE™ Nut Driver	8	Yellow	M5	1	1	4932492369	4058546417369
10mm HOLLOWCORE™ Nut Driver	10	Blue	M6	1	1	4932492370	4058546417376
13mm HOLLOWCORE™ Nut Driver	13	Orange	M8	1	1	4932492371	4058546417383
17mm HOLLOWCORE™ Nut Driver	17	Green	M10	1	1	4932498572	4058546524418
HOLLOWCORE™ Nut Driver Set - 7 pc	5, 5.5, 6, 7, 8, 10, 13	-	M3 - M8	7	1	4932500081	4058546572457

Multi-Nut Driver

NEW

- 3 SHOCKWAVE™ IMPACT DUTY flip nut drivers with 7, 8, 10, 12, 13 and 17mm.
- Designed to hold more nut drivers in one solution.
- Shank and nut drivers compatible with impact drivers.
- Magnetic SHOCKWAVE™ IMPACT DUTY shank.
- On shank storage for easy access.
- Anti-peel cushion grip provides the best ergonomics.



Description	Pack quantity	Min. order quantity	Article Number	EAN Code
6 in 1 Impact Multi-Nut Driver	1	1	4932498179	4058546520489

Tri-Lobe VDE screwdrivers

- VDE tested to 10,000 V and guaranteed to 1,000 V.
- Slim shank diameter for access to low lying screw applications.
- Comfortable Tri-Lobe handle optimized for maximum user comfort and high torque applications.
- Permanent visible ID markings allows for quick tool identification.
- Anti role, 3 sided collar on the handle
- Landyard hole for easy attachment to a safety system.



Description	Pack quantity	Min. order quantity	Article Number	EAN Code
Tri-Lobe VDE screwdriver - slotted 0.4 x 2.5 x 75	1	1	4932478712	4058546349059
Tri-Lobe VDE screwdriver - slotted 0.5 x 3 x 100	1	1	4932478713	4058546349066
Tri-Lobe VDE screwdriver - slotted 0.6 x 3.5 x 100	1	1	4932478714	4058546349073
Tri-Lobe VDE screwdriver - slotted 0.8 x 4 x 100	1	1	4932478715	4058546349080
Tri-Lobe VDE screwdriver - slotted 1.0 x 5.5 x 125	1	1	4932478716	4058546349097
Tri-Lobe VDE screwdriver - slotted 1.2 x 6.5 x 150	1	1	4932478717	4058546349103
Tri-Lobe VDE screwdriver - slotted 1.6 x 8 x 175	1	1	4932478718	4058546349110
Tri-Lobe VDE screwdriver PH0 x60	1	1	4932478720	4058546349134
Tri-Lobe VDE screwdriver PH1 x80	1	1	4932478721	4058546349141
Tri-Lobe VDE screwdriver PH2 x100	1	1	4932478722	4058546349158
Tri-Lobe VDE screwdriver PH3 x150	1	1	4932478723	4058546349165
Tri-Lobe VDE screwdriver PZ0 x60	1	1	4932478724	4058546349172
Tri-Lobe VDE screwdriver PZ1 x80	1	1	4932478725	4058546349189
Tri-Lobe VDE screwdriver PZ2 x100	1	1	4932478726	4058546360085
Tri-Lobe VDE screwdriver PZ3 x150	1	1	4932478727	4058546360092
Tri-Lobe VDE screwdriver T10 x60	1	1	4932478728	4058546360108
Tri-Lobe VDE screwdriver T15 x75	1	1	4932478729	4058546360115
Tri-Lobe VDE screwdriver T20 x100	1	1	4932478730	4058546360122
Tri-Lobe VDE screwdriver T25 x100	1	1	4932478731	4058546360139
Tri-Lobe VDE screwdriver T30 x100	1	1	4932478732	4058546360146
Tri-Lobe VDE screwdriver PH/S L1 x80	1	1	4932478733	4058546360153
Tri-Lobe VDE screwdriver PH/ SL2 x100	1	1	4932478734	4058546360160
Tri-Lobe VDE screwdriver PZ/ SL1 x80	1	1	4932478735	4058546360177
Tri-Lobe VDE screwdriver PZ/ SL2 x100	1	1	4932478736	4058546360184
Voltage tester 0.5 x 3 x 65	1	1	4932478719	4058546349127
① Tri-Lobe VDE screwdriver set - 5 pc PZ1 / PZ2 / SL3 / SL4 and voltage tester	5	1	4932478737	4058546360191
② Tri-Lobe VDE screwdriver PZ set - 7 pc SL2.5 / SL3 / SL4, PH2, PZ1 / PZ2 and voltage tester	7	1	4932478738	4058546360207
③ Tri-Lobe VDE screwdriver PH set - 7 pc SL2.5 / SL3 / SL4 / SL5.5 / PH1 / PH2 and voltage tester	7	1	4932478739	4058546360214
④ Tri-Lobe VDE screwdriver 12 pc set SL2.5 / SL3 / SL4 / SL5.5 / PH1 / PH2 / PZ1 / PZ2 / T10 / T15 / T20 and voltage tester	12	1	4932479095	4058546368890

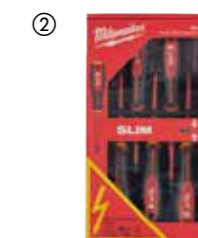

Insulated Multi-Bit Screwdriver

- VDE (DIN EN/IEC 60900) certified tools for added security. Tested to 10,000 volts and guaranteed to 1,000 volts.
- Slim shank diameter for easier access to low lying screws.
- Compact, soft pouch included for quick and easy bit access.
- Laser engraved sizing on the bits for easier identification.
- Lanyard hole for easy attachment to the Milwaukee safety range to allow use at heights.

Description	Min. order quantity	Pack quantity	Article Number	EAN Code
① Insulated 10 in 1 Multi-Bit Screwdriver Set PH1 / PH2 / PZ1 / PZ2 / T10 / T15 / T20 / T25 / SL5.5 / SL/PZ2	1	1	4932493657	4058546485283
② Insulated 4 in 1 Torx Multi-Bit Screwdriver Set T10 / T15 / T20 / T25	1	1	4932493658	4058546485290
③ Insulated 8 in 1 Precision Multi-Bit Screwdriver Set PH00 / PH0 / PZ0 / SL2 / T6 / T7 / T8 / T10	1	1	4932493659	4058546485306

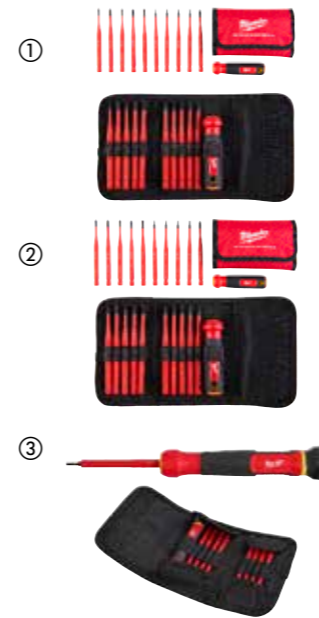

Automatic Wire Stripper

- Fully automatic, self-adjusting wire stripper for all common stranded and solid wires from 0.2 mm² to 16 mm².
- Adjustable length stop from 5 mm to 25 mm for precise working.
- Integrated side cutter to cut wires up to 3 mm Cu/Al.
- The slim head design allows easier access to difficult areas.
- Two component handle design for comfortable handling and maximum force transmission.
- Locking mechanism for a safe storage and space-saving.
- Integrated name tag to customise the tool.
- Lanyard hole for easy attachment to the Milwaukee safety range to allow use at heights.

Description	Min. order quantity	Pack quantity	Article Number	EAN Code
Automatic Wire Stripper	1	1	4932498268	4058546521370



Cable Stripper

- Increased cable strip capacity for all standard round cables with a diameter of 4 mm to 28 mm.
- The adjusting wheel helps to regulate and adjust the cutting depth.
- Automatic changeover from round to longitudinal cut.
- Integrated hook blade for more versatility. Safety cap on the blade reduces the risk of injury.
- Two component handle design for comfortable handling and non-slip.

Description	Min. order quantity	Pack quantity	Article Number	EAN Code
Cable Stripper	1	1	4932498269	4058546521387



4 in 1 Multi-Purpose Stripper

- Cable stripping of all common round and flat cable. Standard round cable strip capacity with a diameter of 6 mm to 13 mm. Standard flat cable up to a width of 18mm.
- Automatic changeover from round to longitudinal cut.
- Wire stripping capacity for all standard stranded and solid wires with the sizes 0.5 mm², 0.8 mm², 1.5 mm², 2.5 mm², 4 mm², 6 mm².
- Cutting blade depth easy adjustable from 0-3mm with a lockable adjusting screw.
- Built in loop maker to bend conductors to loop.
- Ergonomically shaped handle and ridges on the housing to not slip off while working.

Description	Min. order quantity	Pack quantity	Article Number	EAN Code
4 in 1 Multi-Purpose Stripper	1	1	4932498270	405854651394



Multi-Purpose Wire Stripper with Crimper

- Wire stripping capacity for 6 sizes from 0.75mm², 1 mm², 1.5mm², 2.5 mm², 4 mm² to 6mm².
- Wire cutter with double-sided laser hardened cutting edges for the best cut.
- Bolt cutter for M2.5, M3, M3.5, M4 and M5.
- Integrated crimper for insulated and noninsulated terminals.
- The cutting and stripping holes are positioned in front of the pivot to easily fit into tight spaces.
- Ergonomic handle and spring loaded design for fast, one-handed use.
- Rust protection increases tool life by reducing corrosion.

Description	Min. order quantity	Pack quantity	Article Number	EAN Code
Multi-Purpose Wire Stripper with Crimper	1	1	4932493816	4058546509767



Fish tape

- High flexibility tape for easier feeding.
- Thicker tape for better pushing.
- Triple strand design, won't kink.
- Low friction case for smooth pay out.
- Square inner grip for easier winding.

Description	Length (m)	Pack quantity	Min. order quantity	Article Number	EAN Code
① Steel fish tape 7.5 m	7.5	1	1	4932472120	4058546325169
① Steel fish tape 15 m	15	1	1	4932472121	4058546325176
② Polyester fish tape 15 m	15	1	1	4932472118	4058546325145
② Polyester fish tape 30 m	30	1	1	4932472119	4058546325152

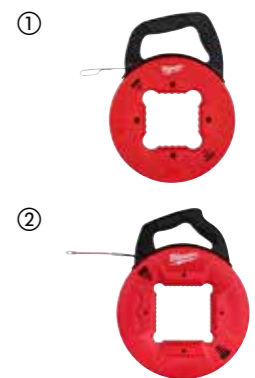

Ratcheting Insulated Terminals Crimper

- 3 crimping cavities to crimp multiple size connectors with one tool. Red (0.3 - 1.0mm²), blue (1.5 - 2.5mm²) and yellow (4.0 - 6.0mm²).
- Dual-ratcheting action provides a full, complete crimp that ensures secure connections.
- High-contrast color-coded markings provides better visibility.
- Quick-release lever for increased productivity.
- Ergonomic handle designed with comfort grips that will not peel.

Description	Pack quantity	Min. order quantity	Article Number	EAN Code
Ratcheting Insulated Terminals Crimper	1	1	4932499025	4058546528942



PLIERS



VDE pliers

- VDE (DIN EN/IEC 60900) certified tools. Tested to 10,000 volts and guaranteed to 1,000 volts. Tested against cold to -40°.
- Steel blades are fully forged, hardened and tempered for best durability. Grey titanium surface finish is non reflective and ensures maximum corrosion resistance.
- Induction hardened cutting edges to cut even the hardest of materials.
- Precision machined joint for maximum power transmission with optimum leverage for easy and effortless work.
- Ergonomic grip with softgrip for comfortable handling and good grip.

Description	Total length (mm)	Pack quantity	Min. order quantity	Article Number	EAN Code
① VDE cable cutter	160	1	1	4932464562	4058546225070
	210	1	1	4932464563	4058546225087
② VDE long round nose plier	205	1	1	4932464564	4058546225094
③ VDE long 45 deg. round nose pliers	205	1	1	4932464565	4058546225100
	145	1	1	4932464566	4058546225117
④ VDE diagonal cutter	160	1	1	4932464567	4058546225124
	180	1	1	4932464568	4058546225131
	180	1	1	4932464569	4058546225148
⑤ VDE heavy duty diagonal cutter	200	1	1	4932464570	4058546225155
	165	1	1	4932464571	4058546225162
⑥ VDE combination plier	180	1	1	4932464572	4058546225179
⑦ VDE wire stripping plier	160	1	1	4932464573	4058546225186
⑧ VDE water pump plier	240	1	1	4932464574	4058546225193
⑨ VDE plier set (3 pc) - Diagonal cutter (160 mm), long nose plier (205 mm), combi plier (180 mm)		3	1	4932464575	4058546225209

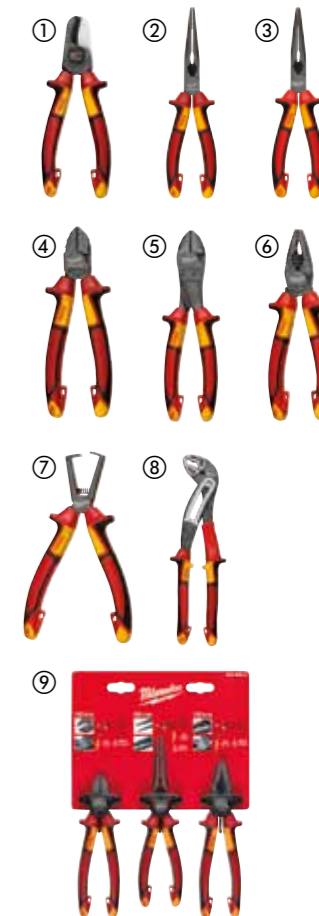

Slip Joint Pliers

NEW

- Large Capacity with up to 9mm more jaw capacity in each of the 3 settings, reducing amount of adjustment needed throughout work on different sizes of nuts, bolts, etc..
- Multi-Functional Gripping Zones With Maxbite™ - combines front & side grip, allows tight & precise grip in wide variety of shapes (e.g. nails, wires, nuts, hose clamps and snap rings) with counter-aligned teeth for perfect grip of rounded off fasteners, bolts & screws.
- Slim Design & Head Shape for optimal access to tight spaces and odd angles e.g. when gripping bolts; perfect for axial rotations.
- Lanyard Hole ensuring increased safety and preventing accidental drops when working at heights.
- Grip Handle with comfortable and firm grip through rubber anti-peel material which is easy to clean.

Description	Pack quantity	Min. order quantity	Article Number	EAN Code
Slip Joint Pliers 200mm	1	1	4932501153	4058546649623



Pliers Wrenches

- Smooth Jaws for damage free work on chrome surfaces e.g. installation of fittings.
- Large Jaw Capacity with up to 12 mm more jaw opening than main competition in same sizes Plier wrench allowing a reduction in tool switching for different size fasteners.
- Smooth Quick Adjust Button for fast & precise size changes directly on the workpiece.
- Best Ratchet-Ability - best range of additional motion at each setting, allows quicker tightening & loosening of fasteners.
- Fully covered handle to avoid reaming, prying & prevent scratching on chrome surfaces.
- Comfortable and firm grip through rubber anti-peel material which is easy to clean.

Description	Pack quantity	Min. order quantity	Article Number	EAN Code
① Pliers Wrench 125 mm	1	1	4932501148	4058546624507
② Pliers Wrench 180 mm	1	1	4932501149	4058546624514
③ Pliers Wrench 250 mm	1	1	4932501150	4058546624521
④ Pliers Wrench 300 mm	1	1	4932501151	4058546624538
⑤ 2pc Pliers Wrench set 180 mm & 250 mm	2	1	4932501152	4058546624545

NEW



Nipping pliers

- Iron carbide edge: Longer blade life.
- Comfort grips: More comfortable than dipped plastic. Grips will not peel.
- Smooth head: Will not mark surface during pull / pry applications.
- Forged design: Tool durability in abusive environments.
- Rust protection: Black oxide finish protect from rust.

Description	Length (mm)	Pack quantity	Min. order quantity	Article Number	EAN Code
Nipping pliers	180	1	1	48226407	045242356096



Pliers

- Precision machined joint for maximum power transmission with optimum leverage for up to 60% less effort needed.
- Induction hardened cutting edges to cut even the hardest of materials.
- Grey titanium surface finish is non reflective and ensures maximum corrosion resistance.
- Two component handle design for comfortable handling and ergonomic grip.
- The combination plier and long nose plier features an Integrated ring spanner to tighten or untighten metric bolts (M8 to M10) .
- The combination plier have a Gripping zone with integrated nail bender and holder. Lanyard hole for easy attachment to the Milwaukee safety range to allow use at heights.
- The adjustable water pump plier features a push button for quick and precise adjustments on the workpiece.
- Double toothed jaw for maximum grip and Induction hardened teeth with self-locking serration to not slipp on the workpiece.
- The adjustable water pump plier has an integrated nail and wire holder.

Description	Pack quantity	Min. order quantity	Article Number	EAN Code
① Combination Plier - 165mm	1	1	4932492461	4058546418281
Combination Plier - 180mm	1	1	4932492462	4058546418298
② Diagonal Cutting Plier - 160mm	1	1	4932492463	4058546418304
③ Heavy Duty Diagonal Cutting Plier - 200mm	1	1	4932492464	4058546418311
④ Long Nose Plier - 205mm	1	1	4932492465	4058546418328
⑤ 45° Long Nose Plier - 205mm	1	1	4932492466	4058546418335
⑥ Adjustable Water Pump Plier - 180mm	1	1	4932492458	4058546418250
Adjustable Water Pump Plier - 250mm	1	1	4932492459	4058546418267
Adjustable Water Pump Plier - 300mm	1	1	4932492460	4058546418274
⑦ 3 Piece Plier Set	3	1	4932492773	4058546476441

1 x Combination plier 180mm 4932492462, 1x Long nose plier 205mm 4932492465, 1 x Diagonal cutting plier 160mm 4932492463



Fencing plier

- Multi-purpose design with 6 different features including a staple puller, staple pincher, fencing wire cutter, fencing wire puller, fencing wire crimper and general purpose hammer.
- Forged head design for the toughest applications.
- Comfort grip handle design that will not peel.
- Black oxide finish protects from rust and is optimal for tough jobsite conditions.



Description	Pack quantity	Min. order quantity	Article Number	EAN Code
Fencing Plier	1	1	4932493926	4058546510862

7 in 1 wire stripping pliers

- Wire stripper : Strips wire sizes 0.75 mm², 1.0 mm², 1.5 mm², 2.5 mm², 4.0 mm², 6.0 mm².
- Wire cutter: With curved laser hardened cutting edges.
- Plier suitable for gripping and bending cables.
- Reaming head for smoothing 12 - 25 mm pipe.
- Loop maker: Built in loop maker function for wire.
- Integrated crimper.
- Integrated bolt cutter.
- One-handed swing lock: Easy one-handed use and remains locked while in pouch. Spring loaded for easy opening.
- Rust protection increases tool life by reducing corrosion.



Description	Strip- ping capac- ities (mm ²)	Cutting capacity in hard wire 1800N/mm ² (Max. Ø mm)	Cutting capac- ity in cable Al and Cu (Max. Ø mm)	De- burring head (Max. Ø mm)	Pack quantity	Min. order quantity	Article Number	EAN Code
7 in 1 combination plier	0.75, 1.0, 1.5, 2.5, 4.0, 6.0	2.5	6.0	25	1	1	4932478554	4058546347475



Heavy Duty Lineman's pliers

- For universal gripping, cutting applications.
- High leverage design: Long handles for maximum cutting power and leverage.
- Deburrer: Deburring ribs on head for up to 25 mm pipe. No need for extra tools.
- Nail puller: Powerful gripping and high leverage.
- Laser hardened durable cutting edges: Cuts wire, bolts, screws and nails. Extra hardened jaws to 64 HRC.
- Serrated gripping zone for strong gripping and pulling.
- Made from Chrome Vanadium steel for best durability and good rust protection.
- Ergonomic and durable overmoulded grips add comfort and last longer.
- With crimping facility.



Cut cap. in hard wire (mm)	Cutting capacity soft wire (mm)	Total length (mm)	Weight (g)	Deburring head (Max. Ø mm)	Pack quantity	Min. order quantity	Article Number	EAN Code
3.0	4.6	250	480	25	1	1	48226100	045242342228



PVC/Oil filter pliers

- Versatile 89mm jaw capacity in a compact 229mm size, offering a solution for multiple plumbing and automotive applications
- Comfort grips that will not peel
- Forged designs for rust protection and increased durability



Description	Length (mm)	Pack quantity	Min. order quantity	Article Number	EAN Code
PVC/Oil filter pliers	229	1	1	4932492511	4058546418786



Long reach pliers

- Deep-reach cross handles for increased reach in tight spaces for best access.
- Multi-function gripping zones for grabbing a wide variety of materials such as screws, cables and round parts.
- Single-joint grip force for more control and better grip compared to double joint.
- Textured nose maintains control when grabbing and twisting with serrated nose.



Description	Length (mm)	Tip Angle (°)	Pack quantity	Min. order quantity	Article Number	EAN Code
Long reach plier - Straight	332	0°	1	1	4932492497	4058546418649
Long reach plier - 45°	326	45°	1	1	4932492498	4058546418656
Long reach pliers 2 pc ets Straight long reach plier, 45° long reach plier			2	1	4932492499	4058546418663



Hose grip pliers

- Deep-reach cross handles for increased reach in tight spaces for best access.
- Multi-function gripping zones for grabbing a wide variety of materials such as screws, cables and round parts.
- Single-joint grip force for more control and better grip compared to double joint.
- Rounded tips to grab hoses without damaging these.



Description	Length (mm)	Pack quantity	Min. order quantity	Article Number	EAN Code
Small diameter hose grip plier	327	1	1	4932492500	4058546418670
Medium diameter hose grip plier	324	1	1	4932492501	4058546418687
Large diameter hose grip plier	321	1	1	4932492502	4058546418694
Hose grip pliers 3 pc set		3	1	4932492503	4058546418700
Small diameter hose grip plier (8mm), medium diameter hose grip plier (12.7mm), large diameter hose grip plier (19mm)					

Circlip pliers

- Easier and quicker internal-external conversion with anti-slip grooved dial.
- All-metal convertible dial for resistance against wear and prevents reduction in joint integrity.
- Slip-resistant grips with double-dipped handles.



Description	Length (mm)	Tip	Tip Angle (°)	Diameter of circle (mm)	Pack quantity	Min. order quantity	Article Number	EAN Code
Small circlip plier - Straight	154	0.9mm	18°	9.5 - 25.4	1	1	4932492487	4058546418540
Small circlip plier - 45°	152	0.9mm	45°	9.5 - 25.4	1	1	4932492488	4058546418557
Small circlip plier - 90°	147	0.9mm	90°	9.5 - 25.4	1	1	4932492489	4058546418564
Medium circlip plier - Straight	154	1.2mm	18°	15.8 - 34.9	1	1	4932492490	4058546418571
Medium circlip plier - 45°	152	1.2mm	45°	15.8 - 34.9	1	1	4932492491	4058546418588
Medium circlip plier - 90°	147	1.2mm	90°	15.8 - 34.9	1	1	4932492492	4058546418595
Large circlip plier - Straight	188	1.8mm	18°	26.9 - 50.8	1	1	4932492493	4058546418601
Large circlip plier - 45°	186	1.8mm	45°	26.9 - 50.8	1	1	4932492494	4058546418618
Large circlip plier - 90°	179	1.8mm	90°	26.9 - 50.8	1	1	4932492495	4058546418625
Circlip pliers 9 pc set					9	1	4932492496	4058546418632
Storage case with a magnetic base, small circlip plier - straight - 0.9mm tip, small circlip plier - 45° - 0.9mm tip, small circlip plier - 90° - 0.9mm tip, medium circlip plier - straight - 1.2mm tip, medium circlip plier - 45° - 1.2mm tip, medium circlip plier - 90° - 1.2mm tip, large circlip plier - straight - 1.8mm tip, large circlip plier - 45° - 1.8mm tip, large circlip plier - 90° - 1.8mm tip								

TORQUE LOCK™ locking pliers

- TORQUE LOCK™: Faster set up and easy release when clamping flat and round material. Extra force can be applied to the TORQUE LOCK™ screw for better and more secure grip. Can also be used for hanging / storage purposes.
- Hardened jaws: Better grip force on jobsite material.
- Rust protection: Chrome plated tool increases life by reducing corrosion.
- Lever release design: Traditional release lever for jobsite convenience.
- MAXBITE™ pliers have special jaw geometry for maximum grip.

	Total length (mm)	Total length (Inch)	Jaw type	Jaw capacity flat (mm)	Jaw opening capacity for pipe (mm)	Pack quantity	Min. order quantity	Article Number	EAN Code
①	170	7	MAXBITE™	-	38	1	1	4932471730	4058546296292
②	250	10	MAXBITE™	-	50	1	1	4932471729	4058546296285
③	72	4	curved	-	18	1	1	4932493618	4058546484897
④	127	5	curved	-	26	1	1	4932472263	4058546339098
⑤	170	7	curved	-	38	1	1	4932471732	4058546296315
⑥	250	10	curved	-	51	1	1	4932471725	4058546296247
⑦	250	10	flat	30	-	1	1	4932471726	4058546296254
⑧	100	4	flat long nose	42	-	1	1	4932472262	4058546339081
⑨	150	6	flat long nose	52	-	1	1	4932471731	4058546296308
⑩	230	9	flat long nose	76	-	1	1	4932471733	4058546296322
⑪	343	12	large capacity	-	90	1	1	4932493619	4058546484903



TORQUE LOCK™ locking C clamps

- TORQUE LOCK™: Faster set up and easy release when clamping flat and round materials for welding. Extra force can be applied to the TORQUE LOCK™ screw for better and more secure grip. Can also be used for hanging / storage purposes.
- Hardened jaws: Better grip force on jobsite material.
- Rust protection: Chrome plated tool increases life by reducing corrosion.
- Lever release design: Traditional release lever for jobsite convenience.

	Total length (mm)	Total length (inch)	Jaw type	Jaw capacity flat (mm)	Pack quantity	Min. order quantity	Article Number	EAN Code
①	230	9	Deep reach regular pointed pads	114	1	1	4932472257	4058546339036
②	480	18	Deep reach regular pointed pads	170	1	1	4932472259	4058546339050
③	280	11	Regular pointed pads	90	1	1	4932471728	4058546296278
④	480	18	Regular pointed pads	170	1	1	4932472260	4058546339067
⑤	230	9	Deep reach swivel pads	114	1	1	4932472258	4058546339043
⑥	280	11	Swivel pads	100	1	1	4932471727	4058546296261
⑦	480	18	Swivel pads	170	1	1	4932472261	4058546339074
⑧	152	6	Regular pointed pads	57.2	1	1	4932493617	4058546484880

TORQUE LOCK™

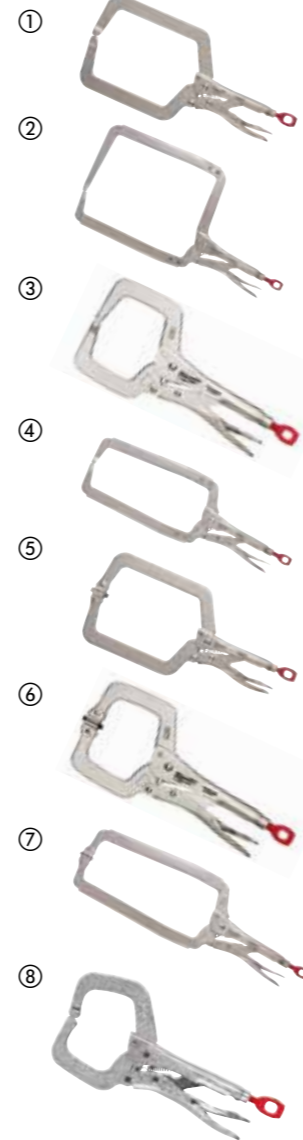

TORQUE LOCK™ locking welder's clamp

- TORQUE LOCK™ enables faster set up and easy release when clamping flat and round material. Extra force can be applied to the TORQUE LOCK™ screw for better and more secure grip. Can also be used for hanging / storage purposes.
- Special U-shaped jaws for a claw-like grip on both round and square-shaped tubing during welding.
- Hardened jaws for better grip force on jobsite material.
- Chrome plated tool increases life by reducing corrosion.

Description	Length (mm)	length (inch)	Pack quantity	Min. order quantity	Article Number	EAN Code
9" - 229mm TORQUE LOCK™ locking welder's clamp	229	9	1	1	4932493616	4058546484873

TORQUE LOCK™



TORQUE LOCK™ seamer

- TORQUE LOCK™: Faster set up and easy release when clamping flat material. Extra force can be applied to the TORQUE LOCK™ screw for better and more secure grip. Can also be used for hanging / storage purposes.
- Hardened jaws: Better grip force on jobsite material.
- Rust protection: Chrome plated tool increases life by reducing corrosion.
- Lever release design: Traditional release lever for jobsite convenience.
- The seamer makes all kinds of bendings, forming, crimping tasks with ease.
- It is ideal for holding sheet metal parts.

Description	Total length (mm)	Total length (inch)	Jaw capacity flat (mm)	Pack quantity	Min. order quantity	Article Number	EAN Code
TORQUE LOCK™ seamer	200	8	42	1	1	4932471734	4058546296339

TORQUE LOCK™



TORQUE LOCK™ chain wrench

- TORQUE LOCK™: Faster set up and easy release when clamping round material. Extra force can be applied to the TORQUE LOCK™ screw for better and more secure grip. Can also be used for hanging / storage purposes.
- Rust protection: Chrome plated tool increases life by reducing corrosion.
- Lever release design: Traditional release lever for jobsite convenience.
- Locking chain wrench holds and locks around any shape object.
- It adjusts quickly for ratchet action in either direction.

Description	Total length (mm)	Total length (inch)	Jaw opening capacity for pipe (mm)	Pack quantity	Min. order quantity	Article Number	EAN Code
TORQUE LOCK™ chain wrench	270	9	79	1	1	4932500043	4058546572075

TORQUE LOCK™



SPANNERS & WRENCHES

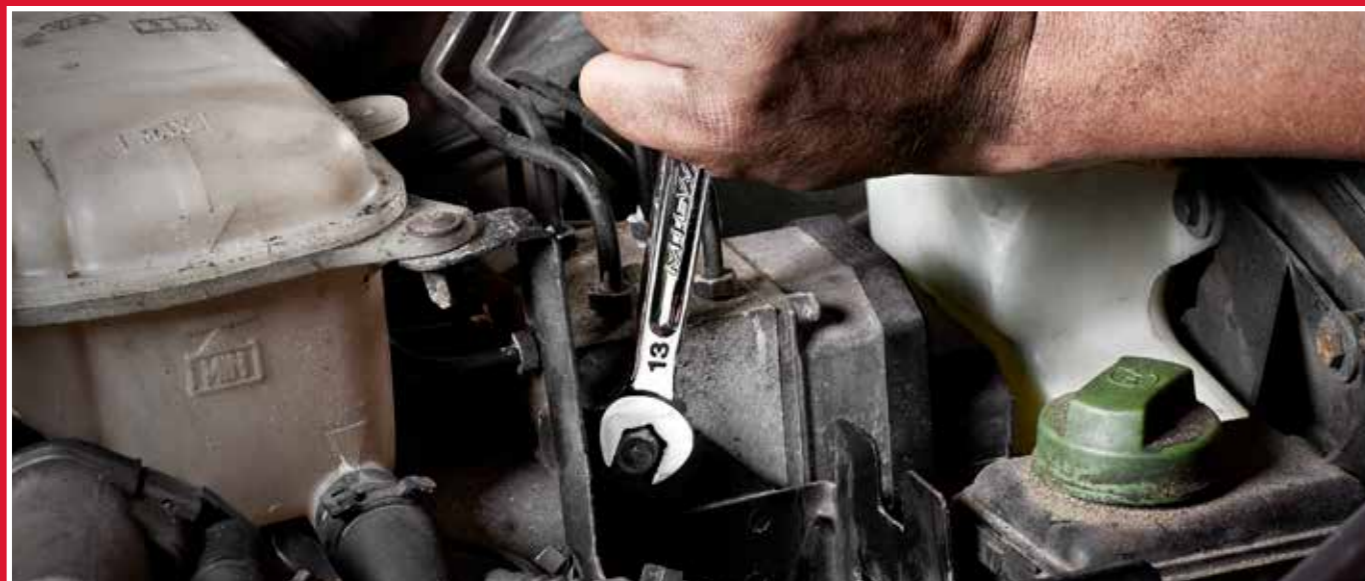

Basin wrench

- Ratchet-compatible design: Accepts 3/8" ratchet.
- Hi-leverage design: Achieve break-away torque on stuck fasteners.
- Door-knob handle: More comfortable than square.
- Easy to adjust handle: Best-in-class adjustability.



Description	Jaw size (mm)	Pack quantity	Min. order quantity	Article Number	EAN Code
Basin wrench compact	10 - 32	1	1	4932500044	4058546572082
Basin wrench	32 - 65	1	1	4932500045	4058546572099

S Jaw pipe wrench

- Made of forged chrome vanadium steel and oil hardened for durability according to DIN 5234.
- Slim, S shaped 45° angled jaws for best reach in confined areas.
- Assymetric serrated induction hardened jaws for maximum grip.
- I-Beam handle design for maximum strength.



Total length (mm)	Capacity pipe [Max. □ mm]	Weight (g)	Pack quantity	Min. order quantity	Article Number	EAN Code
340	52	965	1	1	4932464576	4058546225216
450	67	1570	1	1	4932464577	4058546225223
550	83	3000	1	1	4932464578	4058546225230

MAX BITE™ combination spanner

- MAX BITE™ open-end grip reduces rounding and stripping.
- Rounded I-Beam handle for comfortable handling grip.
- Ink-filled labels for better visibility.
- 15° offset box for better accessibility.



Description	Total length (mm)	Pack quantity	Min. order quantity	Article Number	EAN Code
6 mm MAX BITE™ combination spanner	128	1	1	4932480197	4058546404826
7 mm MAX BITE™ combination spanner	135	1	1	4932480198	4058546404833
8 mm MAX BITE™ combination spanner	140	1	1	4932471516	4058546294151
9 mm MAX BITE™ combination spanner	150	1	1	4932471517	4058546294168
10 mm MAX BITE™ combination spanner	158	1	1	4932471518	4058546294175
11 mm MAX BITE™ combination spanner	165	1	1	4932471519	4058546294182
12 mm MAX BITE™ combination spanner	172	1	1	4932471520	4058546294199
13 mm MAX BITE™ combination spanner	180	1	1	4932471521	4058546294205
14 mm MAX BITE™ combination spanner	190	1	1	4932471522	4058546294212
15 mm MAX BITE™ combination spanner	200	1	1	4932471523	4058546294229
16 mm MAX BITE™ combination spanner	210	1	1	4932471524	4058546294236
17 mm MAX BITE™ combination spanner	225	1	1	4932471525	4058546294243
18 mm MAX BITE™ combination spanner	235	1	1	4932471526	4058546294250
19 mm MAX BITE™ combination spanner	250	1	1	4932471527	4058546294267
20 mm MAX BITE™ combination spanner	262	1	1	4932471528	4058546294274
21 mm MAX BITE™ combination spanner	272	1	1	4932471529	4058546294281
22 mm MAX BITE™ combination spanner	295	1	1	4932471530	4058546294298
23 mm MAX BITE™ combination spanner	310	1	1	4932480199	4058546404840
24 mm MAX BITE™ combination spanner	315	1	1	4932480200	4058546404857
25 mm MAX BITE™ combination spanner	340	1	1	4932480201	4058546404864
26 mm MAX BITE™ combination spanner	340	1	1	4932480202	4058546404871
27 mm MAX BITE™ combination spanner	367	1	1	4932480203	4058546404888
28 mm MAX BITE™ combination spanner	367	1	1	4932480204	4058546404895
29 mm MAX BITE™ combination spanner	393	1	1	4932480205	4058546404901
30 mm MAX BITE™ combination spanner	393	1	1	4932480206	4058546404918
32 mm MAX BITE™ combination spanner	429	1	1	4932480207	4058546404925
36 mm MAX BITE™ combination spanner	513	1	1	4932480208	4058546404932

MAX BITE™ combination spanner sets

- MAX BITE™ open-end grip reduces rounding and stripping.
- Rounded I-Beam handle for comfortable handling grip.
- Optimised storage: 7 pc set with carry handle, 15 pc set in tray for easy storage and connection to tool roller cabinet drawers.
- Ink-filled labels for clear visibility.
- 15° offset box for better accessibility.
- Chrome alloy steel, chrome plated.



Description	Pack quantity	Min. order quantity	Article Number	EAN Code
MAX BITE™ metric combination spanner set (7 pc) ① 8, 10, 12, 13, 14, 15, 17 mm	7	1	4932464257	405854622024
MAX BITE™ metric combination spanner set (15 pc) ② 8, 9, 10, 11, 12, 13, 14, 15, 16, 17, 18, 19, 20, 21, 22 mm	15	1	4932464258	405854622031

15 pc MAXBITE combination spanner set with PACKOUT™ compact organiser

- MAX BITE™ open-end grip reduces rounding and stripping.
- Rounded I-Beam handle for comfortable handling grip.
- Optimised storage: 7 pc set with carry handle, 15 pc set in tray for easy storage and connection to tool roller cabinet drawers.
- Ink-filled labels for clear visibility.
- 15° offset box for better accessibility.
- Part of the PACKOUT™ modular storage system & constructed with impact resistant polymers for jobsite durability.



Description	Pack quantity	Min. order quantity	Article Number	EAN Code
15 pc MAXBITE combination spanner set with PACKOUT™ compact organiser	15	1	4932498141	4058546513016
PACKOUT™ compact organiser (4932464083), MAXBITE combination spanners 8, 9, 10, 11, 12, 13, 14, 15, 16, 17, 18, 19, 20, 21 & 22mm, tray inlay				

MAX BITE™ ratcheting combination spanner

- 144 Ratcheting teeth positions giving 2.5° arc swing allowing access in tighter spaces.
- Durable double stacked pawls for longer ratchet life.
- MAX BITE™ open-end grip reduces rounding and stripping.
- Rounded I-Beam handle for comfortable handling grip.
- Ink-filled labels for better visibility.
- Chrome alloy steel, chrome plated.



Description	Total length (mm)	Pack quantity	Min. order quantity	Article Number	EAN Code
6 mm MAX BITE™ ratcheting combination spanner	134	1	1	4932480209	4058546404949
7 mm MAX BITE™ ratcheting combination spanner	142	1	1	4932480210	4058546404956
8 mm MAX BITE™ ratcheting combination spanner	146	1	1	4932471501	4058546294007
9 mm MAX BITE™ ratcheting combination spanner	156	1	1	4932471502	4058546294014
10 mm MAX BITE™ ratcheting combination spanner	165	1	1	4932471503	4058546294021
11 mm MAX BITE™ ratcheting combination spanner	172	1	1	4932471504	4058546294038
12 mm MAX BITE™ ratcheting combination spanner	179	1	1	4932471505	4058546294045
13 mm MAX BITE™ ratcheting combination spanner	187	1	1	4932471506	4058546294052
14 mm MAX BITE™ ratcheting combination spanner	198	1	1	4932471507	4058546294069
15 mm MAX BITE™ ratcheting combination spanner	208	1	1	4932471508	4058546294076
16 mm MAX BITE™ ratcheting combination spanner	218	1	1	4932471509	4058546294083
17 mm MAX BITE™ ratcheting combination spanner	234	1	1	4932471510	4058546294090
18 mm MAX BITE™ ratcheting combination spanner	243	1	1	4932471511	4058546294106
19 mm MAX BITE™ ratcheting combination spanner	258	1	1	4932471512	4058546294113
20 mm MAX BITE™ ratcheting combination spanner	272	1	1	4932471513	4058546294120
21 mm MAX BITE™ ratcheting combination spanner	282	1	1	4932471514	4058546294137
22 mm MAX BITE™ ratcheting combination spanner	303	1	1	4932471515	4058546294144
24 mm MAX BITE™ ratcheting combination spanner	320	1	1	4932480211	4058546404963
25 mm MAX BITE™ ratcheting combination spanner	341	1	1	4932480212	4058546404970
27 mm MAX BITE™ ratcheting combination spanner	367	1	1	4932480213	4058546404987
30 mm MAX BITE™ ratcheting combination spanner	393	1	1	4932480214	4058546404994
32 mm MAX BITE™ ratcheting combination spanner	429	1	1	4932480215	4058546405007

MAX BITE™ ratcheting combination spanner sets

- 144 Ratcheting teeth positions giving 2.5° arc swing allowing access in tighter spaces.
- Durable double stacked pawls for long-lasting ratchet life.
- MAX BITE™ open-end grip reduces rounding and stripping.
- Ink-filled labels for clear visibility.
- Chrome alloy steel, chrome plated.
- Rounded I-Beam handle for comfortable handling grip.



Description	Pack quantity	Min. order quantity	Article Number	EAN Code
MAX BITE™ ratcheting metric combination spanner set (7 pc) ① 8, 10, 12, 13, 14, 15, 17 mm	7	1	4932464993	4058546229382
MAX BITE™ ratcheting metric combination spanner set (15 pc) ② 8, 9, 10, 11, 12, 13, 14, 15, 16, 17, 18, 19, 20, 21, 22 mm	15	1	4932464994	4058546229399

MAX BITE™ flexible head ratcheting combination spanner

- 180° pivoting head for greater access to tight spaces.
- MAX BITE™ open-end grip reduces rounding and stripping.
- 144 ratcheting teeth positions giving 2.5° arc swing allowing access in tighter spaces.
- Durable double stacked pawls for longer ratchet life.
- Rounded I-Beam handle for comfortable handling grip.
- Ink-filled labels for better visibility.
- Chrome alloy steel, chrome plated.



Description	Total length (mm)	Pack quantity	Min. order quantity	Article Number	EAN Code
8 mm MAX BITE™ flexible head ratcheting combination spanner	146	1	1	4932480181	4058546404666
9 mm MAX BITE™ flexible head ratcheting combination spanner	156	1	1	4932480182	4058546404673
10 mm MAX BITE™ flexible head ratcheting combination spanner	165	1	1	4932480183	4058546404680
11 mm MAX BITE™ flexible head ratcheting combination spanner	172	1	1	4932480184	4058546404697
12 mm MAX BITE™ flexible head ratcheting combination spanner	179	1	1	4932480185	4058546404703
13 mm MAX BITE™ flexible head ratcheting combination spanner	187	1	1	4932480186	4058546404710
14 mm MAX BITE™ flexible head ratcheting combination spanner	198	1	1	4932480187	4058546404727
15 mm MAX BITE™ flexible head ratcheting combination spanner	208	1	1	4932480188	4058546404734
16 mm MAX BITE™ flexible head ratcheting combination spanner	218	1	1	4932480189	4058546404741
17 mm MAX BITE™ flexible head ratcheting combination spanner	233	1	1	4932480190	4058546404758
18 mm MAX BITE™ flexible head ratcheting combination spanner	243	1	1	4932480191	4058546404765
19 mm MAX BITE™ flexible head ratcheting combination spanner	256	1	1	4932480192	4058546404772
20 mm MAX BITE™ flexible head ratcheting combination spanner	272	1	1	4932480193	4058546404789
21 mm MAX BITE™ flexible head ratcheting combination spanner	282	1	1	4932480194	4058546404796
22 mm MAX BITE™ flexible head ratcheting combination spanner	303	1	1	4932480195	4058546404802

MAX BITE™ flexible head ratcheting combination spanner set

- 180° pivoting head for greater access to tight spaces.
- MAX BITE™ open-end grip reduces rounding and stripping.
- 144 ratcheting teeth positions giving 2.5° arc swing allowing access in tighter spaces.
- Durable double stacked pawls for longer ratchet life.
- Rounded I-Beam handle for comfortable handling grip.
- Ink-filled labels for better visibility.
- Chrome alloy steel, chrome plated.

Description	Pack quantity	Min. order quantity	Article Number	EAN Code
① MAX BITE™ metric flexible head ratcheting combination spanner set (7 pc) 8, 10, 12, 13, 14, 15, 17 mm	7	1	4932478557	4058546347505
② MAX BITE™ metric flexible head ratcheting combination spanner set (15 pc) 8, 9, 10, 11, 12, 13, 14, 15, 16, 17, 18, 19, 20, 21, 22 mm	15	1	4932478558	4058546347512

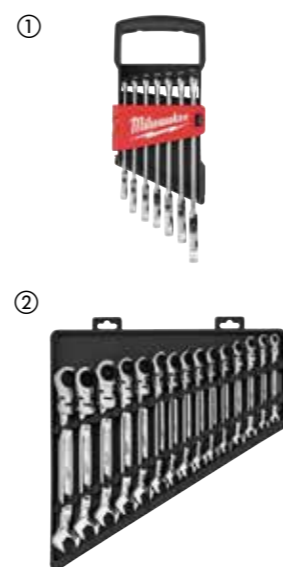

Double open end spanner

- Slim head dimensions for access in tight areas.
- Rounded I-beam handle for comfortably applying torque.
- Ink-filled size labels for easy and quick size identification.
- Chrome finish for corrosion and rust resistance.



Description	Size (mm)	Pack quantity	Min. order quantity	Article Number	EAN Code
Double open end spanner - 4x5mm	4x5mm	1	1	4932492715	4058546475864
Double open end spanner - 6x7mm	6x7mm	1	1	4932492716	4058546475871
Double open end spanner - 8x9mm	8x9mm	1	1	4932492717	4058546475888
Double open end spanner - 8x10mm	8x10mm	1	1	4932492718	4058546475895
Double open end spanner - 10x11mm	10x11mm	1	1	4932492719	4058546475901
Double open end spanner - 10x13mm	10x13mm	1	1	4932492720	4058546475918
Double open end spanner - 12x13mm	12x13mm	1	1	4932492721	4058546475925
Double open end spanner - 12x14mm	12x14mm	1	1	4932492722	4058546475932
Double open end spanner - 13x17mm	13x17mm	1	1	4932492723	4058546475949
Double open end spanner - 14x15mm	14x15mm	1	1	4932492724	4058546475956
Double open end spanner - 16x17mm	16x17mm	1	1	4932492725	4058546475963
Double open end spanner - 17x19mm	17x19mm	1	1	4932492726	4058546475970
Double open end spanner - 18x19mm	18x19mm	1	1	4932492727	4058546475987
Double open end spanner - 20x22mm	20x22mm	1	1	4932492728	4058546475994
Double open end spanner - 21x23mm	21x23mm	1	1	4932492729	4058546476007
Double open end spanner - 22x24mm	22x24mm	1	1	4932492730	4058546476014
Double open end spanner - 24x26mm	24x26mm	1	1	4932493258	4058546481292
Double open end spanner - 24x27mm	24x27mm	1	1	4932492731	4058546476021
Double open end spanner - 25x28mm	25x28mm	1	1	4932492732	4058546476038
Double open end spanner - 27x29mm	27x29mm	1	1	4932492733	4058546476045
Double open end spanner - 30x32mm	30x32mm	1	1	4932492734	4058546476052
Double open end spanner - 34x36mm	34x36mm	1	1	4932492735	4058546476069
Double open end spanner - 36x41mm	36x41mm	1	1	4932492736	4058546476076

Double open end spanner sets

- Slim head dimensions for access in tight areas.
- Rounded I-beam handle for comfortably applying torque.
- Ink-filled size labels for easy and quick size identification.
- Chrome finish for corrosion and rust resistance.
- Sets come in a durable pouch.

Description	Pack quantity	Min. order quantity	Article Number	EAN Code
① Double open end spanner set - 7 pc 6x7mm, 8x9mm, 10x11mm, 12x13mm, 14x15mm, 16x17mm, 18x19mm	7	1	4932492713	4058546475840
② Double open end spanner set - 12 pc 6x7mm, 8x9mm, 10x11mm, 12x13mm, 14x15mm, 16x17mm, 18x19mm, 20x22mm, 21x23mm, 25x28mm, 27x29mm, 30x32mm	12	1	4932492714	4058546475857



Double ring offset spanner

- 75° offset handle for better access in tight spaces.
- Rounded I-beam handle for comfortably applying torque.
- Ink-filled size labels for easy and quick size identification.
- Chrome finish for corrosion and rust resistance.



Description	Pack quantity	Min. order quantity	Article Number	EAN Code
6x7mm Double ring offset spanner	1	1	4932492739	4058546476106
8x9mm Double ring offset spanner	1	1	4932492740	4058546476113
8x10mm Double ring offset spanner	1	1	4932492741	4058546476120
10x11mm Double ring offset spanner	1	1	4932492742	4058546476137
12x13mm Double ring offset spanner	1	1	4932492743	4058546476144
14x15mm Double ring offset spanner	1	1	4932492744	4058546476151
16x17mm Double ring offset spanner	1	1	4932492745	4058546476168
17x19mm Double ring offset spanner	1	1	4932492746	4058546476175
18x19mm Double ring offset spanner	1	1	4932492747	4058546476182
19x22mm Double ring offset spanner	1	1	4932492748	4058546476199
20x22mm Double ring offset spanner	1	1	4932492749	4058546476205
21x23mm Double ring offset spanner	1	1	4932492750	4058546476212
22x24mm Double ring offset spanner	1	1	4932492751	4058546476229
24x26mm Double ring offset spanner	1	1	4932492752	4058546476236
24x27mm Double ring offset spanner	1	1	4932492753	4058546476243
25x28mm Double ring offset spanner	1	1	4932493275	4058546481469
27x30mm Double ring offset spanner	1	1	4932492754	4058546476250
27x32mm Double ring offset spanner	1	1	4932492755	4058546476267
30x32mm Double ring offset spanner	1	1	4932492756	4058546476274

Double ring offset spanner sets

- 75° offset handle for better access in tight spaces.
- Rounded I-beam handle for comfortably applying torque.
- Ink-filled size labels for easy and quick size identification.
- Chrome finish for corrosion and rust resistance.

Description	Pack quantity	Min. order quantity	Article Number	EAN Code
① 7pc Double ring offset spanner 6x7mm, 8x9mm, 10x11mm, 12x13mm, 14x15mm, 16x17mm, 18x19mm	7	1	4932492737	4058546476083
② 12pc Double ring offset spanner set 6x7mm, 8x9mm, 10x11mm, 12x13mm, 14x15mm, 16x17mm, 18x19mm, 20x22mm, 21x23mm, 24x27mm, 25x28mm, 30x32mm	12	1	4932492738	4058546476090



Flare nut spanners

- Optimized head geometry for secure grip on fasteners to reduce rounding of nuts.
- I-beam handle for more comfort while applying high torque.
- Ink-filled size labels for easy and quick size identification.
- 15° angled heads for better access.



Description	Pack quantity	Min. order quantity	Article Number	EAN Code
8 x 10 mm Flare nut spanner	1	1	4932480626	4058546409111
9 x 11 mm Flare nut spanner	1	1	4932480575	4058546408602
10 x 11 mm Flare nut spanner	1	1	4932480627	4058546409128
10 x 12 mm Flare nut spanner	1	1	4932480576	4058546408619
12 x 14 mm Flare nut spanner	1	1	4932480629	4058546409142
13 x 14 mm Flare nut spanner	1	1	4932480577	4058546408626
14 x 17 mm Flare nut spanner	1	1	4932480630	4058546409159
17 x 19 mm Flare nut spanner	1	1	4932480631	4058546409166
19 x 22 mm Flare nut spanner	1	1	4932480632	4058546409173

Flare nut spanner set

- Optimized head geometry for secure grip on fasteners to reduce rounding of nuts.
- I-beam handle for more comfort while applying high torque.
- Ink-filled size labels for easy and quick size identification.
- 15° angled heads for better access.
- Durable storage tray.



Description	Pack quantity	Min. order quantity	Article Number	EAN Code
6pc Flare nut spanner set 8x10mm, 10x11mm, 12x14mm, 14x17mm, 17x19mm, 19x22mm	6	1	4932480636	4058546409210



Steel and aluminium pipe wrenches

- Overbite jaw for secure grip on pipes and fittings.
- Dual coil springs for maximum durability and tool life.
- Ergonomic handle for maximum comfort, won't dig into the palm.
- Hardened jaws for increased durability and better grip.
- Lanyard hole.



Description	Total length (mm)	Total length (inch)	Jaw opening capacity for pipe (mm)	Jaw opening capacity for pipe (inch)	Weight (g)	Pack quantity	Min. order quantity	Article Number	EAN Code
Aluminium pipe wrench 250 mm	250	10	38	1.5	598	1	1	48227210	045242342372
Aluminium pipe wrench 300 mm	300	12	51	2	816	1	1	48227212	045242342389
① Aluminium pipe wrench 350 mm	350	14	51	2	1076	1	1	48227214	045242342396
Aluminium pipe wrench 450 mm	450	18	63	2.5	1630	1	1	48227218	045242342419
Aluminium pipe wrench 600 mm	600	24	76	3	2644	1	1	48227224	045242342426
Steel pipe wrench 250 mm	250	10	38	1.5	916	1	1	48227110	045242342334
Steel pipe wrench 300 mm	300	12	51	2	1270	1	1	48227112	045242342341
② Steel pipe wrench 350 mm	350	14	51	2	1627	1	1	48227114	045242342358
Steel pipe wrench 450 mm	450	18	63	2.5	2531	1	1	48227118	045242342365

Cheater aluminium adjustable pipe wrench

- All in one adjustable sliding handle design between 450 mm & 600 mm.
- Removable handle to 250 mm length for access to tight spaces.
- Aluminium design for lighter weight.
- Overbite jaw for secure grip on pipes and fittings.
- Ergonomic round handle for maximum comfort, won't dig into the palm.
- Hardened jaws for increased durability and better grip.



Description	Total length (inch)	Jaw opening capacity for pipe (mm)	Jaw opening capacity for pipe (inch)	Weight (g)	Pack quantity	Min. order quantity	Article Number	EAN Code
Cheater aluminium adjustable pipe wrench	10 / 18 / 24	63	2.5	2019	1	1	4932478672	4058546348656

CHEATER - adaptable pipe wrench

- 3 handle design - 10"/ 250 mm mode for tight spaces, 18"/ 450 mm mode for general purpose, 24"/ 600 mm mode for maximum leverage and reach.
- Overbite jaw for secure grip on pipes and fittings.
- Dual coil springs for maximum durability and tool life.
- Ergonomic handle for maximum comfort, won't dig into the palm.
- Ergonomic hook jaw design - for easy detachment from the workpiece.
- Hardened jaws for increased durability and better grip.
- Lanyard hole.



Description	Total length (mm)	Total length (inch)	Jaw opening capacity for pipe (mm)	Jaw opening capacity for pipe (inch)	Weight (g)	Pack quantity	Min. order quantity	Article Number	EAN Code
Adaptable pipe wrench	250/450/600	10/18/24	63	2.5	3243	1	1	48227314	045242342402

Adjustable wrenches

- Precision adjustment screw with accurate threads and tight tolerances. The jaws won't back off during use.
- Chrome plating for best-in-class rust protection and increased durability.
- Ergonomic rounded handle design for a comfortable fit in the hand and less pressure points on the palm.
- Slim head design for reaching into tight spaces.
- Parallel jaws won't slip or damage finish surfaces.
- Permanent lasered inch and mm markings for accurate adjustment.
- 8" adjustable wrench (48227508) has an extra wide jaw of 38 mm for increased jaw capacity in confined environments.
- Lanyard hole.



Total length (mm)	Total length (inch)	Jaw opening capacity for pipe (mm)	Jaw thickness (mm)	Tip thickness (mm)	Weight (g)	Pack quantity	Min. order quantity	Article Number	EAN Code
150	6	24.5	11.5	7,7	186	1	1	4932499518	4058546566821
200	8	30	14	8,7	353	1	1	4932499520	4058546566845
200	8	40	14	8,1	385	1	1	48227508	045242356232
① 250	10	36.5	16	9,9	535	1	1	4932499517	4058546566814
300	12	42.5	17	10,8	748	1	1	4932499521	4058546566852
380	15	46	22	13,5	1,470	1	1	4932499516	4058546566807
② Adjustable wrench twin pack 150 mm (48227406) + 250 mm (48227410)						1	2	4932499519	4058546566838
③ Adjustable wrench triple pack 150mm (48227406), 200mm (48227408) + 250mm (48227410)						3	1	4932493414	4058546482855

RATCHETS & SOCKETS



Ratchet and socket sets

- 90 tooth design with 4 °of arc swing for tight work spaces.
- Comes with a removable inner tray perfectly designed to be stored.
- Sockets are stamped with measurements on the flat side for easy-to-read visibility.
- All metal design for maximum durability.
- FOUR FLAT™ sides on socket deter rolling.
- Slim profile head with flush direction lever offers better accessibility.



Description	Pack quantity	Min. order quantity	Article Number	EAN Code
① Metric 1/2" ratchet + socket set (28 pc) Standard sockets: 5 mm, 5.5 mm, 6 mm, 7 mm, 8 mm, 9 mm, 10 mm, 11 mm, 12 mm, 13 mm, 14 mm, 15 mm / Deep well sockets: 5 mm, 5.5 mm, 6 mm, 7 mm, 8 mm, 9 mm, 10 mm, 11 mm, 12 mm, 13 mm, 14 mm, 15 mm / 76 mm extension, 152 mm extension, Universal Joint	28	1	4932464943	4058546228880
② Metric & imperial 1/2" ratchet + socket set (50 pc) Standard sockets: 5/32", 3/16", 1/8", 1/4", 9/32", 5/16", 11/32", 3/8", 7/16", 1/2", 9/16", 5 mm, 5.5 mm, 6 mm, 7 mm, 8 mm, 9 mm, 10 mm, 11 mm, 12 mm, 13 mm, 14 mm, 15 mm / Deep well socket: 5/32", 3/16", 1/8", 1/4", 9/32", 5/16", 11/32", 3/8", 7/16", 1/2", 9/16", 5 mm, 5.5 mm, 6 mm, 7 mm, 8 mm, 9 mm, 10 mm, 11 mm, 12 mm, 13 mm, 14 mm, 15 mm / 76 mm extension, 152 mm extension, universal joint	50	1	4932464944	4058546228897
③ Metric 3/8" ratchet + socket set (32 pc) Standard sockets: 6 mm, 7 mm, 8 mm, 9 mm, 10 mm, 11 mm, 12 mm, 13 mm, 14 mm, 15 mm, 16 mm, 17 mm, 18 mm, 19 mm / Deep well sockets: 6 mm, 7 mm, 8 mm, 9 mm, 10 mm, 11 mm, 12 mm, 13 mm, 14 mm, 15 mm, 16 mm, 17 mm, 18 mm, 19 mm / 76 mm extension, 152 mm extension, universal joint	32	1	4932464945	4058546228903
④ Metric & imperial 3/8" ratchet + socket set (56 pc) Standard sockets: 1/4", 5/16", 3/8", 7/16", 1/2", 9/16", 5/8", 11/16", 3/4", 13/16", 7/8", 15/16", 1", 6 mm, 7 mm, 8 mm, 9 mm, 10 mm, 11 mm, 12 mm, 13 mm, 14 mm, 15 mm, 16 mm, 17 mm, 18 mm, 19 mm / Deep well sockets: 1/4", 5/16", 3/8", 7/16", 1/2", 9/16", 5/8", 11/16", 3/4", 13/16", 7/8", 15/16", 1", 6 mm, 7 mm, 8 mm, 9 mm, 10 mm, 11 mm, 12 mm, 13 mm, 14 mm, 15 mm, 16 mm, 17 mm, 18 mm, 19 mm / 76 mm extension, 152 mm extension, universal joint	56	1	4932464946	4058546228910
⑤ Metric 1/2" ratchet + socket set (28 pc) Standard sockets: 10 mm, 11 mm, 12 mm, 13 mm, 14 mm, 15 mm, 16 mm, 17 mm, 18 mm, 19 mm, 20 mm, 21 mm, 22 mm, 23 mm, 24 mm / Deep well sockets: 10 mm, 11 mm, 12 mm, 13 mm, 14 mm, 15 mm, 16 mm, 17 mm, 18 mm, 19 mm / 76 mm extension, 127 mm extension & removable storage tray	28	1	4932471864	4058546297633
⑥ Metric 1/2" ratchet + socket set (28 pc) in PACKOUT™ compact slim organiser Standard sockets: 5 mm, 5.5 mm, 6 mm, 7 mm, 8 mm, 9 mm, 10 mm, 11 mm, 12 mm, 13 mm, 14 mm, 15 mm / Deep well sockets: 5 mm, 5.5 mm, 6 mm, 7 mm, 8 mm, 9 mm, 10 mm, 11 mm, 12 mm, 13 mm, 14 mm, 15 mm / 76 mm extension, 152 mm extension, Universal Joint	28	1	4932478812	4058546360948
⑦ Metric 3/8" ratchet + socket set (32 pc) in PACKOUT™ compact slim organiser Standard sockets: 6 mm, 7 mm, 8 mm, 9 mm, 10 mm, 11 mm, 12 mm, 13 mm, 14 mm, 15 mm, 16 mm, 17 mm, 18 mm, 19 mm / Deep well sockets: 6 mm, 7 mm, 8 mm, 9 mm, 10 mm, 11 mm, 12 mm, 13 mm, 14 mm, 15 mm, 16 mm, 17 mm, 18 mm, 19 mm / 76 mm extension, 152 mm extension, universal joint	32		4932478813	4058546360955
⑧ PACKOUT™ 1/4" & 1/2" 63pc ratchet and socket set PACKOUT SLIM ORGANISER, 1/2" Drive Standard sockets: 10 mm, 11 mm, 12 mm, 13 mm, 14 mm, 15 mm, 16 mm, 17 mm, 18 mm, 19 mm, 20 mm, 21 mm, 22 mm, 23 mm, 24 mm, 25 mm, 26 mm / Deep sockets: 10 mm, 11 mm, 12 mm, 13 mm, 14 mm, 15 mm, 16 mm, 17 mm, 18 mm, 19 mm / 1/2" Drive 76 mm extension, 127 mm extension, 1/2 Drive Universal joint; 1/4" Drive Standard sockets: 4mm, 4.5mm, 5 mm, 5.5 mm, 6 mm, 7 mm, 8 mm, 9 mm, 10 mm, 11 mm, 12 mm, 13 mm, 14 mm, 15 mm / Deep well sockets: 4 mm, 4.5 mm, 5 mm, 5.5 mm, 6 mm, 7 mm, 8 mm, 9 mm, 10 mm, 11 mm, 12 mm, 13 mm, 14 mm, 15 mm / 1/4" Drive 76 mm extension, 152 mm extension, 1/4" Drive Universal Joint	63	1	4932493661	4058546485320

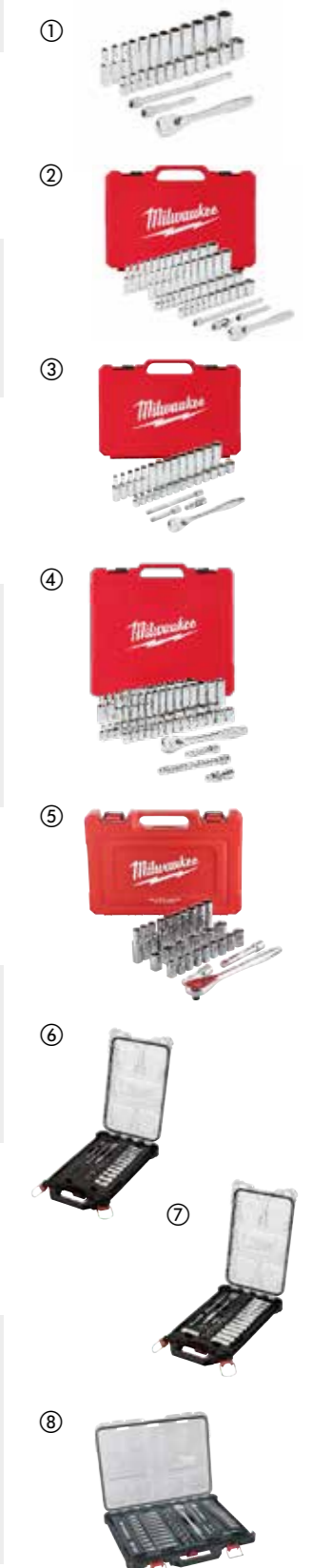

1/4" Ratchet, driver & socket set

- 90 tooth design with 4 ° of arc swing for tight work spaces.
- FOUR FLAT™ sides on socket deter rolling.
- Sockets are stamped with measurements on the flat side for easy-to-read visibility.
- Comfortable Tri-Lobe screwdriver handle optimised for maximum user comfort and high torque applications.
- SHOCKWAVE™ IMPACT DUTY Screwdriver bits

Description	Pack quantity	Min. order quantity	Article Number	EAN Code
① 1/4" Ratchet, Driver & Socket set in PACKOUT™ compatible box	38	1	4932498381	4058546522506

1/4 Ratchet , 1/4 Tri-lobe screwdriver handle, Standard sockets: 5.5 mm, 6 mm, 7 mm 8 mm, 9 mm, 10 mm, 11 mm, 12 mm, 13 mm, 14 mm, Extensions: 76 mm, 152 mm, Shockwave Bits: SL4.5 / SL5.5 / SL6.5 / PH1 / PH2 / PH3 / PZ1 / PZ2 / PZ3 / HEX 3 / HEX 4 / HEX 5 / HEX 6 / HEX 8 / TR10 / TR15 / TR20 / TR25 / TR27 / TR30 / TR40, Uni joint, Socket adaptor, 1/4SQ-1/4 Hex socket



DESIGNED FOR USE IN
PACKOUT



1/4" Drive ratchet, spanner & deep socket premium set

- MILWAUKEE® ratchet with 90 ratcheting teeth for only 4° of arc swing and stubby handle design for better access.
- FOUR FLAT™ sides on socket deter rolling and wrench-ready design.
- Flex head ratcheting spanner with 144 tooth count providing an arc swing of 2.5° allowing access in tighter spaces.
- SHOCKWAVE™ IMPACT DUTY Screwdriver bits

Description	Pack quantity	Min. order quantity	Article Number	EAN Code
42 pc 1/4" Drive ratchet, spanner & deep socket premium set metric	42	1	4932498382	4058546522513

1/4" Drive deep sockets: 5, 6, 7, 8, 9, 10, 11, 12, 13, 14, 15 mm, Screwdriver handle, SHOCKWAVE™ IMPACT DUTY screwdriver bits: PH1, PH2, PH3, PZ1, PZ2, PZ3, SL 4.5, SL 5.5, Hex 3, Hex 4, Hex 5, Hex 6, Hex 8, T10 B0, T15 B0, T20 B0, T25 B0, T27 B0, T30 B0, T40 B0, Flex Head Ratcheting Combination Spanner: 8 mm, 10 mm, 13 mm



DESIGNED FOR USE IN
PACKOUT



1/4" Drive compact ratchet set in PACKOUT™ compatible box

- 90 ratcheting teeth for 4 ° arc swing and stubby handle length to work easily in tight spaces.
- Unique Four Flat Sides™ providing an anti-roll design and wrench-ready solution.
- Designed for use with impact drivers the SHOCKWAVE™ IMPACT DUTY bits line is not only ideal for heavy duty impact applications, but also delivers a full system solution for all the user's drilling and fastening needs.

Description	Pack quantity	Min. order quantity	Article Number	EAN Code
25 pc 1/4" Drive compact ratchet set in PACKOUT™ compatible box	25	1	4932499470	4058546566340

1/4" Drive compact ratchet, 1/4" drive sockets: 6, 7, 8, 10, 13mm, 1/4" drive bit holder socket, SHOCKWAVE™ IMPACT DUTY bits PH1, PH2, PH3, PZ1, PZ2, PZ3, SL 4.5mm, SL 5.5mm, SL 6.5mm, Hex 3mm, Hex 4mm, Hex 5mm, Hex 6mm, T10, T15, T20, T25, T30



DESIGNED FOR USE IN
PACKOUT

1/4" Compact ratchet set

- MILWAUKEE® ratchet with 90 ratcheting teeth for only 4° of arc swing and stubby handle design for better access.
- FOUR FLAT SIDES™ sockets providing a wrench ready and anti-roll design.
- Designed for use with impact drivers the SHOCKWAVE™ IMPACT DUTY bits line is not only ideal for heavy duty impact applications, but also delivers a full system solution for all the user's drilling and fastening needs.
- High quality textile pouch and removable foam insert.

Description	Pack quantity	Min. order quantity	Article Number	EAN Code
1/4" Compact Ratchet Set 39 PC	39	1	4932492672	4058546475437

1/4" compact ratchet, 1/4" universal joint, 76mm extension, 13x 1/4" sockets (4, 4.5, 5, 5.5, 6, 7, 8, 9, 10, 11, 12, 13, 14mm), 1/4" Sq to 1/4" socket adapter, 22x SHOCKWAVE™ IMPACT DUTY Bits (PH1, PH2, PZ1, PZ2, TX B08, TX B010, TX B015, TX B020, TX B025, TX B030, TX B040, SL0.8x5x5, TX 10, TX 15, TX 20, TX 25, TX 30, TX 40, Hex 3mm, Hex 4mm, Hex 5mm, Hex 6mm)



Tradesman 3/8" ratchet set

- Pivoting ratchet head.
- Slim profile design for better access.
- Square shaped sockets compatible with combination spanners.
- Organised and portable storage solution.

Description	Pack quantity	Min. order quantity	Article Number	EAN Code
Tradesman 3/8" ratchet set (12 pc)	12	1	4932501196	4058546639129

3/8" sockets: 10, 12, 13, 14, 15, 17, 18 and 19 mm.
3/8" ratchet. 152 mm extension. 1/4" to 3/8" adaptor and 3/8" to 1/2" adaptor



7 in 1 Micro ratchet

- 90 tooth design with 4 ° of arc swing for tight work spaces.
- Mini bits PH1, PH2, SL5.5, T15 for access in tight areas.
- 1/4" socket adapter to be able to apply on 1/4" sockets.
- Versatile usage due to 1/4" nut driver on one side and 5/16" nut driver on the other side of the ratchets head.
- Versatile finger loop with clip for easy storage and a secure grip.
- Attachable bit holder keeps bits with ratchet.

Description	Pack quantity	Min. order quantity	Article Number	EAN Code
7 in 1 Micro ratchet	1	1	4932498792	4058546526610

Mini bits: PH1, PH2, SL5.5, T15 / 1/4" Socket adapter / 1/4" and 5/16" Nut driver



1/4" Drive click torque wrench

NEW

- Strong click provides powerful, tactile feedback that lets you know exactly when the set torque is reached - ensuring precision.
- ±3% Accuracy for accurate and precise torque readings.
- 4° Arc swing with a 90 tooth ratcheting design for quick and easy access even in tight spaces.
- Durable, high contrast markings for quick and easy readability.
- Ribbed locking ring on top of the handle helps preventing accidental release.
- Knurled handle for added grip and comfort.



Description	Pack quantity	Min. order quantity	Article Number	EAN Code
1/4" Drive click torque wrench 5-25NM	1	1	4932500823	4058546621254

1/4" drive ratchet

- 90 tooth design with 4 °of arc swing for tight work spaces.
- Slim profile head with flush direction lever offers better accessibility.

Description	Length (mm)	Pack quantity	Min. order quantity	Article Number	EAN Code
① 1/4" drive compact ratchet	76	1	1	4932479646	4058546374402
② 1/4" drive ratchet	152	1	1	4932499523	4058546566876
③ 1/4" drive long ratchet	229	1	1	4932479647	4058546374419



1/4" drive flex head ratchet

- 90 tooth design with 4 °of arc swing for tight work spaces.
- Versatile lockable flex head: Switch between 7 locking positions and freely moving head.
- Slim profile head with flush direction lever offers better accessibility.
- Standard and extended handle lengths for easier access in tight spaces or extra leverage.

Description	Length (mm)	Pack quantity	Min. order quantity	Article Number	EAN Code
1/4" drive flexible head ratchet	140	1	1	4932479648	4058546374426
1/4" drive long flexible head ratchet	229	1	1	4932479649	4058546374433



Spinner handle

- Ergonomically shaped TRI-LOBE handle design to comfortably apply high torque.
- Anti-roll protection due to TRI-LOBE design.
- Ball detent for a secure hold onto sockets.
- Lanyard hole for easy attachment to the Milwaukee safety range to allow use at heights.



Description	Pack quantity	Min. order quantity	Article Number	EAN Code
1/4" Drive spinner handle	1	1	4932493960	4058546511203

1/4" Drive chrome sockets with FOUR FLAT™ sides

- FOUR FLAT™ sides on socket deter rolling.
- Wrench ready FOUR FLAT™ sides.
- Stamped sizes for easy visibility.
- Chrome finish.



Description	Width (mm)	Diameter (mm)	Length (mm)	Pack quantity	Min. order quantity	Article Number	EAN Code
1/4" drive - 4 mm	9.7	6.8	25	1	1	4932479992	4058546377861
1/4" drive - 4.5 mm	9.7	7.2	25	1	1	4932479993	4058546377878
1/4" drive - 5 mm	9.5	8	25	1	1	4932478312	4058546345037
1/4" drive - 5.5 mm	9.5	8.6	25	1	1	4932478313	4058546345044
1/4" drive - 6 mm	9.5	9.5	25	1	1	4932478314	4058546345051
1/4" drive - 7 mm	9.5	10.7	25	1	1	4932478315	4058546345068
1/4" drive - 8 mm	9.5	11.8	25	1	1	4932478316	4058546345075
1/4" drive - 9 mm	11.1	12.8	25	1	1	4932478317	4058546345082
1/4" drive - 10 mm	11.1	14.5	25	1	1	4932478318	4058546345099
1/4" drive - 11 mm	12.7	15.8	25	1	1	4932478319	4058546345105
1/4" drive - 12 mm	14	16.8	25	1	1	4932478320	4058546345112
1/4" drive - 13 mm	14.3	17.8	25	1	1	4932478321	4058546345129
1/4" drive - 14 mm	15.9	19.8	25	1	1	4932478322	4058546345136
1/4" drive - 15 mm	16	20.8	25	1	1	4932478323	4058546345143
1/4" deep drive - 4 mm	9.7	7.2	50	1	1	4932479994	4058546377885
1/4" deep drive - 4.5 mm	9.7	20.8	50	1	1	4932479995	4058546377892
1/4" drive deep - 5 mm	9.3	8	50	1	1	4932478324	4058546345150
1/4" drive deep - 5.5 mm	9.3	8.6	50	1	1	4932478325	4058546345167
1/4" drive deep - 6 mm	9.3	9.8	50	1	1	4932478326	4058546345174
1/4" drive deep - 7 mm	9.3	10.8	50	1	1	4932478327	4058546345181
1/4" drive deep - 8 mm	9.3	11.8	50	1	1	4932478328	4058546345198
1/4" drive deep - 9 mm	10.8	12.8	50	1	1	4932478329	4058546345204
1/4" drive deep - 10 mm	10.8	14.8	50	1	1	4932478330	4058546345211
1/4" drive deep - 11 mm	12.4	15.8	50	1	1	4932478331	4058546345228
1/4" drive deep - 12 mm	13.7	16.8	50	1	1	4932478332	4058546345235
1/4" drive deep - 13 mm	14	17.8	50	1	1	4932478333	4058546345242
1/4" drive deep - 14 mm	15.6	19.8	50	1	1	4932478334	4058546345259
1/4" drive deep - 15 mm	15.6	20.8	50	1	1	4932478335	4058546345266

1/4" Drive hex bit socket

- FOUR FLAT™ sides on socket deter rolling and provide a wrench-ready design.
- Slim design for better access in tight spaces.
- Single forged piece adds durability in high torque applications.
- Stamped sizes for better visibility in all lighting conditions.



Description	Total length (mm)	Pack quantity	Min. order quantity	Article Number	EAN Code
1/4" Drive 2mm hex bit socket	40	1	1	4932480823	4058546411084
1/4" Drive 2.5mm hex bit socket	40	1	1	4932480824	4058546411091
1/4" Drive 3mm hex bit socket	40	1	1	4932480825	4058546411107
1/4" Drive 4mm hex bit socket	40	1	1	4932480826	4058546411114
1/4" Drive 5mm hex bit socket	40	1	1	4932480827	4058546411121
1/4" Drive 6mm hex bit socket	40	1	1	4932480828	4058546411138
1/4" Drive 8mm hex bit socket	40	1	1	4932480829	4058546411145
1/4" Drive Metric Hex Bit Socket Set - 6 pc 2mm, 2.5mm, 3mm, 4mm, 5mm, 6mm		6	1	4932480566	4058546408510



1/4" Drive External Torx Socket

NEW

- FOUR FLAT™ sides on socket deter rolling.
- Wrench ready FOUR FLAT™ sides.
- Stamped sizes for easy visibility.
- Chrome finish for easy cleaning and corrosion protection.



Description	Pack quantity	Min. order quantity	Article Number	EAN Code
1/4" Drive E4 External Torx Socket	1	1	4932498846	4058546527150
1/4" Drive E5 External Torx Socket	1	1	4932498847	4058546527167
1/4" Drive E6 External Torx Socket	1	1	4932498848	4058546527174
1/4" Drive E7 External Torx Socket	1	1	4932498849	4058546527181
1/4" Drive E8 External Torx Socket	1	1	4932498850	4058546527198
1/4" Drive E10 External Torx Socket	1	1	4932498851	4058546527204

1/4" Drive torx bit socket

- FOUR FLAT™ sides on socket deter rolling and provide a wrench-ready design.
- Slim design for better access in tight spaces.
- Single forged piece adds durability in high torque applications.
- Stamped sizes for better visibility in all lighting conditions.



Description	Total length (mm)	Pack quantity	Min. order quantity	Article Number	EAN Code
1/4" Drive T8 Bit Socket	40	1	1	4932480792	4058546410773
1/4" Drive T10 Bit Socket	40	1	1	4932480793	4058546410780
1/4" Drive T15 Bit Socket	40	1	1	4932480794	4058546410797
1/4" Drive T20 Bit Socket	40	1	1	4932480795	4058546410803
1/4" Drive T25 Bit Socket	40	1	1	4932480796	4058546410810
1/4" Drive T27 Bit Socket	40	1	1	4932480797	4058546410827
1/4" Drive T30 Bit Socket	40	1	1	4932480798	4058546410834
1/4" Drive T40 Bit Socket	40	1	1	4932480799	4058546410841
① 1/4" Drive TX Bit Socket Set - 6 pc T8, T10, T15, T20, T25, T27		6	1	4932480563	4058546414160
② 1/4" and 3/8" Drive TX Bit Socket Set - 13 pc		13	1	4932480565	4058546408503
1/4" Drive: T8, T10, T15, T20, T25, T27; 3/8" Drive: T30, T40, T45, T47, T50, T55, T60					

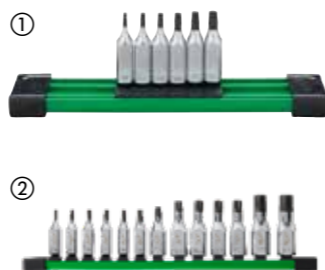

1/4" Drive adapter

- FOUR FLAT™ sides on socket deter rolling.
- Wrench ready FOUR FLAT™ sides.
- Drive size conversion for increasing the drive size of ratchet allowing usage on a wider variety of sockets.
- Laser engraved size ID for easy and quick size identification.
- Chrome finish for corrosion and rust protection.



Description	Pack quantity	Min. order quantity	Article Number	EAN Code
1/4" Drive 1/4" X 3/8" Adapter	1	1	4932480646	4058546409319

1/4" Drive universal joint adapter

- Universal Joint provides easier access in hard to reach spaces to get every job done, both in the garage and on the jobsite.
- Ball detent securely holds the socket to the adapter.
- Chrome finish for optimal resistance to corrosion and rust.



Description	Pack quantity	Min. order quantity	Article Number	EAN Code
1/4" Drive Universal Joint Adapter	1	1	4932480939	4058546412241

1/4" Drive bit holder

- Spring collar to securely hold bits.
- Chrome finish for improved rust protection.
- 1/4" Hex bit reception to work with the most common bit sizes.



Description	Pack quantity	Min. order quantity	Article Number	EAN Code
1/4" Drive Bit Holder for 1/4" Hex Bits	1	1	4932493961	4058546511210

1/4" Drive extensions

- Precision knurling located on the shaft and female drive end for better control when hand threading.
- Laser engraved size ID for quick and easy identification.
- Chrome finish for corrosion and rust protection.



Description	Pack quantity	Min. order quantity	Article Number	EAN Code
1/4" Drive 38mm extension	1	1	4932480907	4058546411923
1/4" Drive 76mm extension	1	1	4932480908	4058546411930
1/4" Drive 152mm extension	1	1	4932480909	4058546411947
1/4" Drive 356mm extension	1	1	4932480910	4058546411954
1/4" drive extension set - 4 pc 38mm, 76mm, 152mm, 356mm	4	1	4932480637	4058546409227

1/4" Drive locking extensions

NEW

- Knurled locking collar keeps socket securely attached.
- Precision knurling located on the shaft and female drive end for better control when hand threading.
- Chrome finish for corrosion and rust protection.
- Laser engraved size ID for quick and easy identification.



Description	Pack quantity	Min. order quantity	Article Number	EAN Code
1/4" Drive 76mm locking extension	1	1	4932480930	4058546412159
1/4" Drive 152mm locking extension	1	1	4932480931	4058546412166
1/4" Drive 254mm locking extension	1	1	4932480932	4058546412173
3pc 1/4" Drive locking extension set 76mm, 152mm, 254mm	3	1	4932480643	4058546409289

1/4" Drive wobble extensions

- Wobble functionality provides additional access in tight spaces and can also be used as a standard extension when fully inserted.
- Precision knurling located on the shaft and female drive end for better control when hand threading.
- Chrome finish for corrosion and rust protection.
- Laser engraved size ID for quick and easy identification.



Description	Pack quantity	Min. order quantity	Article Number	EAN Code
1/4" Drive 51mm wobble extension	1	1	4932480919	4058546412043
1/4" Drive 102mm wobble extension	1	1	4932480920	4058546412050
1/4" Drive 152mm wobble extension	1	1	4932480921	4058546412067
1/4" Drive 305mm wobble extension	1	1	4932480922	4058546412074
4pc 1/4" Drive wobble extension set 51mm, 102mm, 152mm, 305mm	4	1	4932480640	4058546409258

3/8" Drive click torque wrench

NEW

- Strong click provides powerful, tactile feedback that lets you know exactly when the set torque is reached - ensuring precision.
- ±3% Accuracy for accurate and precise torque readings.
- 4° Arc swing with a 90 tooth ratcheting design for quick and easy access even in tight spaces.
- Durable, high contrast markings for quick and easy readability.
- Ribbed locking ring on top of the handle helps preventing accidental release.
- Knurled handle for added grip and comfort.



Description	Pack quantity	Min. order quantity	Article Number	EAN Code
3/8" Drive click torque wrench 10-50NM	1	1	4932500850	4058546621520
3/8" Drive click torque wrench 20-100NM	1	1	4932500824	4058546621261

3/8" drive ratchet

- 90 tooth design with 4 °of arc swing for tight work spaces.
- Slim profile head with flush direction lever offers better accessibility.

Description	Length (mm)	Pack quantity	Min. order quantity	Article Number	EAN Code
① 3/8" drive compact ratchet	127	1	1	4932479650	4058546374440
② 3/8" drive ratchet	216	1	1	4932499524	4058546566883
③ 3/8" drive long ratchet	305	1	1	4932479651	4058546374457



3/8" drive flex head ratchet

- 90 tooth design with 4 °of arc swing for tight work spaces.
- Versatile lockable flex head: Switch between 9 locking positions and freely moving head.
- Slim profile head with flush direction lever offers better accessibility.
- Standard and extended handle lengths for easier access in tight spaces or extra leverage.

Description	Length (mm)	Pack quantity	Min. order quantity	Article Number	EAN Code
3/8" drive flexible head ratchet	216	1	1	4932479652	4058546374464
3/8" drive long flexible head ratchet	305	1	1	4932479653	4058546374471



3/8" Drive chrome sockets with FOUR FLAT™ sides

- FOUR FLAT™ sides on socket deter rolling.
- Wrench ready FOUR FLAT™ sides.
- Stamped sizes for easy visibility.
- Chrome finish.



Description	Width (mm)	Diameter (mm)	Length (mm)	Pack quantity	Min. order quantity	Article Number	EAN Code
3/8" drive - 6 mm	14.3	10.3	28	1	1	4932478336	4058546345273
3/8" drive - 7 mm	14.3	10.9	28	1	1	4932478337	4058546345280
3/8" drive - 8 mm	14.3	12	28	1	1	4932478338	4058546345297
3/8" drive - 9 mm	14.3	13.3	28	1	1	4932478339	4058546345303
3/8" drive - 10 mm	14.3	14.8	28	1	1	4932478340	4058546345310
3/8" drive - 11 mm	14.3	16.3	28	1	1	4932478341	4058546345327
3/8" drive - 12 mm	14.3	17.8	28	1	1	4932478342	4058546345334
3/8" drive - 13 mm	15.9	18.3	28	1	1	4932478343	4058546345341
3/8" drive - 14 mm	15.9	19.8	28	1	1	4932478344	4058546345358
3/8" drive - 15 mm	17	21.3	28	1	1	4932478345	4058546345365
3/8" drive - 16 mm	17.5	22	28	1	1	4932478346	4058546345372
3/8" drive - 17 mm	19	23.8	28	1	1	4932478347	4058546345389
3/8" drive - 18 mm	20	24.3	28	1	1	4932478348	4058546345396
3/8" drive - 19 mm	20	25.8	28	1	1	4932478349	4058546345402
3/8" drive - 20 mm	22.7	27.8	30	1	1	4932479996	4058546377908
3/8" drive - 21 mm	22.7	27.8	30	1	1	4932479997	4058546377915
3/8" drive - 22 mm	23.7	29.8	30	1	1	4932479998	4058546377922
3/8" drive - 23 mm	26.7	31.8	30	1	1	4932479999	4058546377939
3/8" drive - 24 mm	26.7	31.8	30	1	1	4932480000	4058546377946
3/8" drive deep - 6 mm	14	10.3	63	1	1	4932478350	4058546345419
3/8" drive deep - 7 mm	14	10.9	63	1	1	4932478351	4058546345426
3/8" drive deep - 8 mm	14	12	63	1	1	4932478352	4058546345433
3/8" drive deep - 9 mm	14	13.3	63	1	1	4932478353	4058546345440
3/8" drive deep - 10 mm	14	14.5	63	1	1	4932478354	4058546345457
3/8" drive deep - 11 mm	14	16.8	63	1	1	4932478355	4058546345464
3/8" drive deep - 12 mm	14	17.3	63	1	1	4932478356	4058546345471
3/8" drive deep - 13 mm	16	18.8	63	1	1	4932478357	4058546345488
3/8" drive deep - 14 mm	17	19.8	63	1	1	4932478358	4058546345495
3/8" drive deep - 15 mm	18	21.3	63	1	1	4932478359	4058546345501
3/8" drive deep - 16 mm	19	21.8	63	1	1	4932478360	4058546345518
3/8" drive deep - 17 mm	21	23.8	63	1	1	4932478361	4058546345525
3/8" drive deep - 18 mm	21	24.3	63	1	1	4932478362	4058546345532
3/8" drive deep - 19 mm	22	25.8	63	1	1	4932478363	4058546345549
3/8" deep drive - 20 mm	22.7	27.8	63	1	1	4932480001	4058546377953
3/8" deep drive - 21 mm	22.7	27.8	63	1	1	4932480002	4058546377960
3/8" deep drive - 22 mm	23.7	29.8	63	1	1	4932480003	4058546377977
3/8" deep drive - 23 mm	26.7	31.8	63	1	1	4932480004	4058546377984
3/8" deep drive - 24 mm	26.7	31.8	63	1	1	4932480005	4058546377991

3/8" Drive chrome socket set

- FOUR FLAT™ sides on socket deter rolling
- Wrench ready FOUR FLAT™ sides
- Stamped sizes for easy visibility
- Chrome finish for easy cleaning and corrosion protection
- Stored on a socket rail for better tool organization

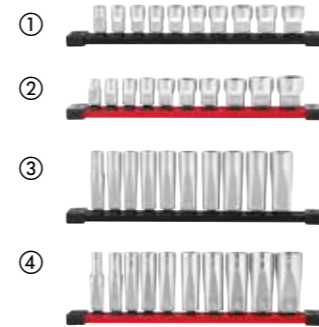

Description	Height (mm)	Length (mm)	Pack quantity	Min. order quantity	Article Number	EAN Code
① 3/8" Drive 10PC Metric Chrome Sockets	44	273	10	1	4932492507	4058546418748
② 3/8" Drive 10PC Imperial Chrome Sockets	44	273	10	1	4932492508	4058546418755
③ 3/8" Drive 10 PC Metric Deep Chrome Sockets	77	273	10	1	4932492509	4058546418762
④ 3/8" Drive 10PC Imperial Deep Chrome Socket Set	77	273	10	1	4932492510	4058546418779

3/8" Drive Metric Standard 12-Point Socket

NEW

- FOUR FLAT™ sides on socket deter rolling.
- Wrench ready FOUR FLAT™ sides.
- Stamped sizes for easy visibility.
- Chrome finish for easy cleaning and corrosion protection.



Description	Pack quantity	Min. order quantity	Article Number	EAN Code
3/8" Drive Metric Standard 12-Point Socket - 8mm	1	1	4932498800	4058546526696
3/8" Drive Metric Standard 12-Point Socket - 9mm	1	1	4932498801	4058546526702
3/8" Drive Metric Standard 12-Point Socket - 10mm	1	1	4932498802	4058546526719
3/8" Drive Metric Standard 12-Point Socket - 11mm	1	1	4932498803	4058546526726
3/8" Drive Metric Standard 12-Point Socket - 12mm	1	1	4932498804	4058546526733
3/8" Drive Metric Standard 12-Point Socket - 13mm	1	1	4932498805	4058546526740
3/8" Drive Metric Standard 12-Point Socket - 14mm	1	1	4932498806	4058546526757
3/8" Drive Metric Standard 12-Point Socket - 15mm	1	1	4932498807	4058546526764
3/8" Drive Metric Standard 12-Point Socket - 16mm	1	1	4932498808	4058546526771
3/8" Drive Metric Standard 12-Point Socket - 17mm	1	1	4932498809	4058546526788
3/8" Drive Metric Standard 12-Point Socket - 18mm	1	1	4932498810	4058546526795
3/8" Drive Metric Standard 12-Point Socket - 19mm	1	1	4932498811	4058546526801
12 pc 3/8" Drive 12-Point Standard Socket Set - Metric				
3/8" Drive 12-Point Standard Sockets: 8mm, 9mm, 10mm, 11mm, 12mm, 13mm, 14mm, 15mm, 16mm, 17mm, 18mm, 19mm	12	1	4932498795	4058546526641



3/8" Drive spark plug socket

- Dual-material rubber retainer prevents wear down and enables secure hold.
- Stamped sizes for quick and easy identification.
- Knurling area for better finger grip.
- Pin hole to enable securing of socket.



Description	Length (mm)	Diameter (mm)	Pack quantity	Min. order quantity	Article Number	EAN Code
3/8" Drive 3/16" Spark Plug Socket	68	14.29	1	1	4932480674	4058546409593
3/8" Drive 14mm Spark Plug Socket	68	14	1	1	4932480679	4058546409647
3/8" Drive 16mm Spark Plug Socket	68	16	1	1	4932480676	4058546409616
3/8" Drive 16mm Magnetic Spark Plug Socket	68	16	1	1	4932480675	4058546409609
3/8" Drive 18mm Spark Plug Socket	68	18	1	1	4932480680	4058546409654
3/8" Drive 20.8mm Spark Plug Socket	68	20.8	1	1	4932480677	4058546409623
3/8" Drive 20.8mm Magnetic Spark Plug Socket	68	20.8	1	1	4932480678	4058546409630

3/8" Drive Metric Deep 12-Point Socket

NEW

- FOUR FLAT™ sides on socket deter rolling.
- Wrench ready FOUR FLAT™ sides.
- Stamped sizes for easy visibility.
- Chrome finish for easy cleaning and corrosion protection.



Description	Pack quantity	Min. order quantity	Article Number	EAN Code
3/8" Drive Metric Deep 12-Point Socket - 8mm	1	1	4932498812	4058546526818
3/8" Drive Metric Deep 12-Point Socket - 9mm	1	1	4932498813	4058546526825
3/8" Drive Metric Deep 12-Point Socket - 10mm	1	1	4932498814	4058546526832
3/8" Drive Metric Deep 12-Point Socket - 11mm	1	1	4932498815	4058546526849
3/8" Drive Metric Deep 12-Point Socket - 12mm	1	1	4932498816	4058546526856
3/8" Drive Metric Deep 12-Point Socket - 13mm	1	1	4932498817	4058546526863
3/8" Drive Metric Deep 12-Point Socket - 14mm	1	1	4932498818	4058546526870
3/8" Drive Metric Deep 12-Point Socket - 15mm	1	1	4932498819	4058546526887
3/8" Drive Metric Deep 12-Point Socket - 16mm	1	1	4932498820	4058546526894
3/8" Drive Metric Deep 12-Point Socket - 17mm	1	1	4932498821	4058546526900
3/8" Drive Metric Deep 12-Point Socket - 18mm	1	1	4932498822	4058546526917
3/8" Drive Metric Deep 12-Point Socket - 19mm	1	1	4932498823	4058546526924
12 pc 3/8" Drive 12-Point Deep Socket Set - Metric				
3/8" Drive 12-Point Deep Sockets: 8mm, 9mm, 10mm, 11mm, 12mm, 13mm, 14mm, 15mm, 16mm, 17mm, 18mm, 19mm	12	1	4932498796	4058546526658



3/8" Drive External Torx Socket

- FOUR FLAT™ sides on socket deter rolling.
- Wrench ready FOUR FLAT™ sides.
- Stamped sizes for easy visibility.
- Chrome finish for easy cleaning and corrosion protection.



Description	Pack quantity	Min. order quantity	Article Number	EAN Code
3/8" Drive E12 External Torx Socket	1	1	4932498852	4058546527211
3/8" Drive E14 External Torx Socket	1	1	4932498853	4058546527228
3/8" Drive E16 External Torx Socket	1	1	4932498854	4058546527235

3/8" Drive spark plug socket set 4pc

- Dual-material rubber retainer prevents wear down and enables secure hold.
- Stamped sizes for quick and easy identification.
- Knurling area for better finger grip.
- Pin hole to enable securing of socket.



Description	Min. order quantity	Pack quantity	Article Number	EAN Code
4pc 3/8" Drive spark plug socket set on rail	1	1	4932498383	4058546522520

3/8" Drive torx bit socket

- FOUR FLAT™ sides on socket deter rolling and provide a wrench-ready design.
- Slim design for better access in tight spaces.
- Single forged piece adds durability in high torque applications.
- Stamped sizes for better visibility in all lighting conditions.



Description	Total length (mm)	Pack quantity	Min. order quantity	Article Number	EAN Code
3/8" Drive T10 Bit Socket	45	1	1	4932480800	4058546410858
3/8" Drive T15 bit socket	45	1	1	4932480801	4058546410865
3/8" Drive T20 bit socket	45	1	1	4932480802	4058546410872
3/8" Drive T25 bit socket	45	1	1	4932480803	4058546410889
3/8" Drive T27 bit socket	45	1	1	4932480804	4058546410896
3/8" Drive T30 bit socket	45	1	1	4932480805	4058546410902
3/8" Drive T40 bit socket	50	1	1	4932480806	4058546410919
3/8" Drive T45 bit socket	50	1	1	4932480807	4058546410926
3/8" Drive T47 bit socket	50	1	1	4932480808	4058546410933
3/8" Drive T50 bit socket	50	1	1	4932480809	4058546410940
3/8" Drive T55 bit socket	55	1	1	4932480810	4058546410957
3/8" Drive T60 bit socket	50	1	1	4932480811	4058546410964
3/8" Drive TX Bit Socket Set - 10 pc T20, T25, T27, T30, T40, T45, T47, T50, T55, T60		10	1	4932480564	4058546408497

3/8" Drive hex bit socket

- FOUR FLAT™ sides on socket deter rolling and provide a wrench-ready design.
- Slim design for better access in tight spaces.
- Single forged piece adds durability in high torque applications.
- Stamped sizes for better visibility in all lighting conditions.



Description	Total length (mm)	Pack quantity	Min. order quantity	Article Number	EAN Code
3/8" Drive 3mm hex bit socket	45	1	1	4932480830	4058546411152
3/8" Drive 4mm hex bit socket	45	1	1	4932480831	4058546411169
3/8" Drive 5mm hex bit socket	45	1	1	4932480832	4058546411176
3/8" Drive 6mm hex bit socket	45	1	1	4932480833	4058546411183
3/8" Drive 7mm hex bit socket	50	1	1	4932480834	4058546411190
3/8" Drive 8mm hex bit socket	50	1	1	4932480835	4058546411206
3/8" Drive 9mm hex bit socket	50	1	1	4932480836	4058546411213
3/8" Drive 10mm hex bit socket	50	1	1	4932480837	4058546411220
3/8" Drive 11mm hex bit socket	55	1	1	4932480838	4058546411237
3/8" Drive 12mm hex bit socket	55	1	1	4932480839	4058546411244
3/8" Drive 13mm hex bit socket	55	1	1	4932480840	4058546411251
3/8" Drive 14mm hex bit socket	55	1	1	4932480841	4058546411268
3/8" Drive Metric Hex Bit Socket Set - 11 pc 4mm, 5mm, 6mm, 7mm, 8mm, 9mm, 10mm, 11mm, 12mm, 13mm, 14mm		11	1	4932480567	4058546408527

3/8" Drive adapter

- FOUR FLAT™ sides on socket deter rolling.
- Wrench ready FOUR FLAT™ sides.
- Drive size conversion for increasing or decreasing the drive size of ratchet allowing usage on a wider variety of sockets.
- Laser engraved size ID for easy and quick size identification.
- Chrome finish for corrosion and rust protection.



Description	Pack quantity	Min. order quantity	Article Number	EAN Code
3/8" Drive 3/8" F X 1/2" M Adapter	1	1	4932480647	4058546409326
3/8" Drive 3/8" F X 3/4" M Adapter	1	1	4932480648	4058546409333

3/8" Drive universal joint adapter

- Universal Joint provides easier access in hard to reach spaces to get every job done, both in the garage and on the jobsite.
- Ball detent securely holds the socket to the adapter.
- Chrome finish for optimal resistance to corrosion and rust.



Description	Pack quantity	Min. order quantity	Article Number	EAN Code
3/8" Drive Universal Joint Adapter	1	1	4932480940	4058546412258

3/8" Drive bit holder

- Ball detent for a secure hold onto bits.
- Chrome finish for improved rust protection.
- 1/4" Hex bit reception to work with the most common bit sizes.



Description	Pack quantity	Min. order quantity	Article Number	EAN Code
3/8" Drive Bit Holder for 1/4" Hex Bits	1	1	4932493962	4058546511227

3/8" Drive extensions

- Precision knurling located on the shaft and female drive end for better control when hand threading.
- Laser engraved size ID for quick and easy identification.
- Chrome finish for corrosion and rust protection.



Description	Pack quantity	Min. order quantity	Article Number	EAN Code
3/8" Drive 38mm extension	1	1	4932480911	4058546411961
3/8" Drive 76mm extension	1	1	4932480912	4058546411978
3/8" Drive 152mm extension	1	1	4932480913	4058546411985
3/8" Drive 356mm extension	1	1	4932480914	4058546411992
3/8" drive extension set - 4 pc 38mm, 76mm, 152mm, 356mm	4	1	4932480638	4058546409234

3/8" Drive locking extensions

- Knurled locking collar keeps socket securely attached.
- Precision knurling located on the shaft and female drive end for better control when hand threading.
- Chrome finish for corrosion and rust protection.
- Laser engraved size ID for quick and easy identification.



Description	Pack quantity	Min. order quantity	Article Number	EAN Code
3/8" Drive 76mm locking extension	1	1	4932480933	4058546412180
3/8" Drive 152mm locking extension	1	1	4932480934	4058546412197
3/8" Drive 254mm locking extension	1	1	4932480935	4058546412203
3pc 3/8" Drive locking extension set 76mm, 152mm, 254mm	3	1	4932480644	4058546409296

3/8" Drive wobble extensions

- Wobble functionality provides additional access in tight spaces and can also be used as a standard extension when fully inserted.
- Precision knurling located on the shaft and female drive end for better control when hand threading.
- Chrome finish for corrosion and rust protection.
- Laser engraved size ID for quick and easy identification.



Description	Pack quantity	Min. order quantity	Article Number	EAN Code
3/8" Drive 76mm wobble extension	1	1	4932480923	4058546412081
3/8" Drive 152mm wobble extension	1	1	4932480924	4058546412098
3/8" Drive 254mm wobble extension	1	1	4932480925	4058546412104
3/8" Drive 305mm wobble extension	1	1	4932480926	4058546412111
4pc 3/8" Drive wobble extension set 76mm, 152mm, 254mm, 305mm	4	1	4932480641	4058546409265

1/2" Drive click torque wrench

NEW

- Strong click provides powerful, tactile feedback that lets you know exactly when the set torque is reached - ensuring precision.
- ±3% Accuracy for accurate and precise torque readings.
- 4° Arc swing with a 90 tooth ratcheting design for quick and easy access even in tight spaces.
- Durable, high contrast markings for quick and easy readability.
- Ribbed locking ring on top of the handle helps preventing accidental release.
- Knurled handle for added grip and comfort.



Description	Pack quantity	Min. order quantity	Article Number	EAN Code
1/2" Drive click torque wrench 40-200NM	1	1	4932500851	4058546621537
1/2" Drive click torque wrench 60-340NM	1	1	4932500825	4058546621278

1/2" drive ratchet

- 90 tooth design with 4 ° of arc swing for tight work spaces.
- Slim profile head with flush direction lever offers better accessibility.



Description	Length (mm)	Pack quantity	Min. order quantity	Article Number	EAN Code
1/2" drive ratchet	286	1	1	4932471865	4058546297640
1/2" drive long ratchet	457	1	1	4932479654	4058546374488

1/2" drive flex head ratchet

- 90 tooth design with 4 ° of arc swing for tight work spaces.
- Versatile lockable flex head: Switch between 11 locking positions and freely moving head.
- Slim profile head with flush direction lever offers better accessibility.
- Standard and extended handle lengths for easier access in tight spaces or extra leverage.



Description	Length (mm)	Pack quantity	Min. order quantity	Article Number	EAN Code
1/2" drive flexible head ratchet	286	1	1	4932479655	4058546374495
1/2" drive long flexible head ratchet	457	1	1	4932479656	4058546374501

1/2" Drive adapter

- FOUR FLAT™ sides on socket deter rolling
- Wrench ready FOUR FLAT™ sides
- Drive size conversion for increasing the drive size of ratchet allowing usage on a wider variety of sockets
- Laser engraved size ID for easy and quick size identification
- Chrome finish for corrosion and rust protection



Description	Pack quantity	Min. order quantity	Article Number	EAN Code
1/2" Drive 1/2" X 3/8" Adapter	1	1	4932480649	4058546409340

1/2" Drive chrome sockets with FOUR FLAT™ sides

- FOUR FLAT™ sides on socket deter rolling.
- Wrench ready FOUR FLAT™ sides.
- Stamped sizes for easy visibility.
- Chrome finish.



Description	Width (mm)	Diameter (mm)	Length (mm)	Pack quantity	Min. order quantity	Article Number	EAN Code
1/2" drive - 8 mm	17.7	13.7	38	1	1	4932480006	4058546378004
1/2" drive - 9 mm	17.7	14.2	38	1	1	4932480007	4058546378011
1/2" drive - 10 mm	18.8	15.3	38	1	1	4932480008	4058546378028
1/2" drive - 11 mm	18.8	16.8	38	1	1	4932480009	4058546378035
1/2" drive - 12 mm	18.8	17.8	38	1	1	4932480010	4058546378042
1/2" drive - 13 mm	18.8	19	38	1	1	4932480011	4058546378059
1/2" drive - 14 mm	18.8	20.3	38	1	1	4932480012	4058546378066
1/2" drive - 15 mm	18.8	21.8	38	1	1	4932480013	4058546378073
1/2" drive - 16 mm	18.8	21.8	38	1	1	4932480014	4058546378080
1/2" drive - 17 mm	19.4	23.8	38	1	1	4932480015	4058546378097
1/2" drive - 18 mm	20.5	25.8	38	1	1	4932480016	4058546378103
1/2" drive - 19 mm	20.5	25.8	38	1	1	4932480017	4058546378110
1/2" drive - 20 mm	22.1	27.8	38	1	1	4932480018	4058546378127
1/2" drive - 21 mm	22.1	27.8	38	1	1	4932480019	4058546378134
1/2" drive - 22 mm	23.3	29.8	38	1	1	4932480020	4058546378141
1/2" drive - 23 mm	25.3	31.8	39	1	1	4932480021	4058546378158
1/2" drive - 24 mm	25.3	31.8	39	1	1	4932480022	4058546378165
1/2" drive - 25 mm	27.7	33.8	42	1	1	4932480023	4058546378172
1/2" drive - 26 mm	27.7	33.8	42	1	1	4932480024	4058546378189
1/2" drive - 27 mm	29.7	35.8	42	1	1	4932480025	4058546378196
1/2" drive - 28 mm	29.7	37.8	42	1	1	4932480026	4058546378202
1/2" drive - 30 mm	32.7	39.8	44	1	1	4932480027	4058546378219
1/2" drive - 32 mm	33.8	41.8	44	1	1	4932480028	4058546378226
1/2" drive - 36 mm	37.8	45.8	48	1	1	4932480029	4058546378233
1/2" drive deep - 10 mm	18.8	15	78	1	1	4932480030	4058546378240
1/2" drive deep - 11 mm	18.8	16.8	78	1	1	4932480031	4058546378257
1/2" drive deep - 12 mm	18.8	17.8	78	1	1	4932480032	4058546378264
1/2" drive deep - 13 mm	18.8	19	78	1	1	4932480033	4058546420550
1/2" drive deep - 14 mm	18.8	20.3	78	1	1	4932480034	4058546376048
1/2" drive deep - 15 mm	18.8	21.8	78	1	1	4932480035	4058546376055
1/2" drive deep - 16 mm	18.8	21.8	78	1	1	4932480036	4058546376062
1/2" drive deep - 17 mm	19.4	23.8	78	1	1	4932480037	4058546376079
1/2" drive deep - 18 mm	20.5	25.8	78	1	1	4932480038	4058546376086
1/2" drive deep - 19 mm	20.5	25.8	78	1	1	4932480039	4058546376093
1/2" drive deep - 20 mm	22.7	27.8	78	1	1	4932480040	4058546376109
1/2" drive deep - 21 mm	22.7	27.8	78	1	1	4932480041	4058546376116
1/2" drive deep - 22 mm	23.7	29.8	78	1	1	4932480042	4058546403270
1/2" drive deep - 23 mm	26.7	31.8	78	1	1	4932480043	4058546403287
1/2" drive deep - 24 mm	26.7	31.8	78	1	1	4932480044	4058546403294
1/2" drive deep - 27 mm	29.7	35.8	78	1	1	4932480045	4058546403300
1/2" drive deep - 30 mm	32.7	39.8	78	1	1	4932480046	4058546403317
1/2" drive deep - 32 mm	33.8	41.8	78	1	1	4932480047	4058546403324
1/2" drive deep - 36 mm	37.8	45.8	78	1	1	4932480048	4058546403331

1/2" Drive hex bit socket

- FOUR FLAT™ sides on socket deter rolling and provide a wrench-ready design.
- Slim design for better access in tight spaces.
- Single forged piece adds durability in high torque applications.
- Stamped sizes for better visibility in all lighting conditions.



Description	Total length (mm)	Min. order quantity	Pack quantity	Article Number	EAN Code
1/2" Drive 4mm hex bit socket	55	1	1	4932480842	4058546411275
1/2" Drive 5mm hex bit socket	55	1	1	4932480843	4058546411282
1/2" Drive 6mm hex bit socket	55	1	1	4932480844	4058546411299
1/2" Drive 7mm hex bit socket	55	1	1	4932480845	4058546411305
1/2" Drive 8mm hex bit socket	55	1	1	4932480846	4058546411312
1/2" Drive 9mm hex bit socket	55	1	1	4932480847	4058546411329
1/2" Drive 10mm hex bit socket	55	1	1	4932480848	4058546411336
1/2" Drive 12mm hex bit socket	55	1	1	4932480849	4058546411343
1/2" Drive 14mm hex bit socket	55	1	1	4932480850	4058546411350
1/2" Drive 17mm hex bit socket	65	1	1	4932480851	4058546411367
1/2" Drive 19mm hex bit socket	65	1	1	4932480852	4058546411374
1/2" Drive Metric Hex Bit Socket Set - 10 pc		1	10	4932480853	4058546411381

1/2" Drive torx bit socket

- FOUR FLAT™ sides on socket deter rolling and provide a wrench-ready design.
- Slim design for better access in tight spaces.
- Single forged piece adds durability in high torque applications.
- Stamped sizes for better visibility in all lighting conditions.



Description	Total length (mm)	Min. order quantity	Pack quantity	Article Number	EAN Code
1/2" Drive T20 Bit Socket	55	1	1	4932480812	4058546410971
1/2" Drive T25 Bit Socket	55	1	1	4932480813	4058546410988
1/2" Drive T27 Bit Socket	55	1	1	4932480814	4058546410995
1/2" Drive T30 Bit Socket	55	1	1	4932480815	4058546411008
1/2" Drive T40 Bit Socket	55	1	1	4932480816	4058546411015
1/2" Drive T45 Bit Socket	55	1	1	4932480817	4058546411022
1/2" Drive T50 Bit Socket	55	1	1	4932480818	4058546411039
1/2" Drive T55 Bit Socket	55	1	1	4932480819	4058546411046
1/2" Drive T60 Bit Socket	65	1	1	4932480820	4058546411053
1/2" Drive T70 Bit Socket	65	1	1	4932480821	4058546411060
1/2" Drive TX Bit Socket Set - 10 pc		1	9	4932480822	4058546411077

1/2" Drive Metric Standard 12-Point Socket

NEW

- FOUR FLAT™ sides on socket deter rolling.
- Wrench ready FOUR FLAT™ sides.
- Stamped sizes for easy visibility.
- Chrome finish for easy cleaning and corrosion protection.



Description	Pack quantity	Min. order quantity	Article Number	EAN Code
1/2" Drive Metric Standard 12-Point Socket - 12mm	1	1	4932499115	4058546529840
1/2" Drive Metric Standard 12-Point Socket - 13mm	1	1	4932499116	4058546529857
1/2" Drive Metric Standard 12-Point Socket - 14mm	1	1	4932498824	4058546526931
1/2" Drive Metric Standard 12-Point Socket - 15mm	1	1	4932498825	4058546526948
1/2" Drive Metric Standard 12-Point Socket - 16mm	1	1	4932498826	4058546526955
1/2" Drive Metric Standard 12-Point Socket - 17mm	1	1	4932498827	4058546526962
1/2" Drive Metric Standard 12-Point Socket - 18mm	1	1	4932498828	4058546526979
1/2" Drive Metric Standard 12-Point Socket - 19mm	1	1	4932498829	4058546526986
1/2" Drive Metric Standard 12-Point Socket - 20mm	1	1	4932498830	4058546526993
1/2" Drive Metric Standard 12-Point Socket - 21mm	1	1	4932498831	4058546527006
1/2" Drive Metric Standard 12-Point Socket - 22mm	1	1	4932498832	4058546527013
1/2" Drive Metric Standard 12-Point Socket - 23mm	1	1	4932498833	4058546527020
1/2" Drive Metric Standard 12-Point Socket - 24mm	1	1	4932498834	4058546527037
13 pc 1/2" 12 Point Standard Socket Set - Metric				
1/2" Drive 12-Point Standard Sockets: 12mm, 13mm, 14mm, 15mm, 16mm, 17mm, 18mm, 19mm, 20mm, 21mm, 22mm, 23mm, 24mm	13	1	4932498797	4058546526665

1/2" Drive Metric Deep 12-Point Socket

NEW

- FOUR FLAT™ sides on socket deter rolling.
- Wrench ready FOUR FLAT™ sides.
- Stamped sizes for easy visibility.
- Chrome finish for easy cleaning and corrosion protection.



Description	Pack quantity	Min. order quantity	Article Number	EAN Code
1/2" Drive Metric Deep 12-Point Socket - 12mm	1	1	4932499117	4058546529864
1/2" Drive Metric Deep 12-Point Socket - 13mm	1	1	4932499118	4058546529871
1/2" Drive Metric Deep 12-Point Socket - 14mm	1	1	4932498835	4058546527044
1/2" Drive Metric Deep 12-Point Socket - 15mm	1	1	4932498836	4058546527051
1/2" Drive Metric Deep 12-Point Socket - 16mm	1	1	4932498837	4058546527068
1/2" Drive Metric Deep 12-Point Socket - 17mm	1	1	4932498838	4058546527075
1/2" Drive Metric Deep 12-Point Socket - 18mm	1	1	4932498839	4058546527082
1/2" Drive Metric Deep 12-Point Socket - 19mm	1	1	4932498840	4058546527099
1/2" Drive Metric Deep 12-Point Socket - 20mm	1	1	4932498841	4058546527105
1/2" Drive Metric Deep 12-Point Socket - 21mm	1	1	4932498842	4058546527112
1/2" Drive Metric Deep 12-Point Socket - 22mm	1	1	4932498843	4058546527129
1/2" Drive Metric Deep 12-Point Socket - 23mm	1	1	4932498844	4058546527136
1/2" Drive Metric Deep 12-Point Socket - 24mm	1	1	4932498845	4058546527143
13 pc 1/2" 12 Point Deep Socket Set - Metric				
1/2" Drive 12-Point Deep Sockets: 12mm, 13mm, 14mm, 15mm, 16mm, 17mm, 18mm, 19mm, 20mm, 21mm, 22mm, 23mm, 24mm	13	1	4932498798	4058546526672

1/2" Drive External Torx Socket

NEW

- FOUR FLAT™ sides on socket deter rolling.
- Wrench ready FOUR FLAT™ sides.
- Stamped sizes for easy visibility.
- Chrome finish for easy cleaning and corrosion protection.



Description	Pack quantity	Min. order quantity	Article Number	EAN Code
1/2" Drive E10 E-TX Socket	1	1	4932500314	4058546616168
1/2" Drive E12 E-TX Socket	1	1	4932500315	4058546616175
1/2" Drive E14 E-TX Socket	1	1	4932500316	4058546616182
1/2" Drive E16 E-TX Socket	1	1	4932500317	4058546616199
1/2" Drive E18 E-TX Socket	1	1	4932498855	4058546527242
1/2" Drive E20 E-TX Socket	1	1	4932498856	4058546527259
1/2" Drive E24 E-TX Socket	1	1	4932498858	4058546527273

12pc 1/4", 3/8", 1/2" Drive External Torx Socket Set - Metric

NEW

- FOUR FLAT™ sides on socket deter rolling.
- Wrench ready FOUR FLAT™ sides.
- Stamped sizes for easy visibility.
- Chrome finish for easy cleaning and corrosion protection.
- Stored on a socket rail for better tool organization.



Description	Pack quantity	Min. order quantity	Article Number	EAN Code
12 pc 1/4", 3/8", 1/2" Drive External Torx Standard Socket Set - Metric	12	1	4932498799	4058546526689
1/4" Drive: E4, E5, E6, E7, E8, E10; 3/8" Drive: E12, E14, E16; 1/2" Drive: E18, E20, E24				

1/2" drive universal joint

- Improved joint durability to withstand higher torque.
- Wobble drive to provide additional access and can also be used in the standard position when socket is fully inserted.
- Allows access to difficult angles that cannot be reached with a fixed ratchet and socket.
- Chrome finish for corrosion and rust resistance.
- Laser engraved size label for quick and easy identification.



Description	Pack quantity	Min. order quantity	Article Number	EAN Code
1/2" drive universal joint	1	1	4932480650	4058546409357

1/2" Drive extensions

- Precision knurling located on the shaft and female drive end for better control when hand threading.
- Laser engraved size ID for quick and easy identification.
- Chrome finish for corrosion and rust protection.



Description	Pack quantity	Min. order quantity	Article Number	EAN Code
1/2" Drive 76mm extension	1	1	4932480915	4058546412005
1/2" Drive 127mm extension	1	1	4932480916	4058546412012
1/2" Drive 254mm extension	1	1	4932480917	4058546412029
1/2" Drive 381mm extension	1	1	4932480918	4058546412036
1/2" drive extension set - 4 pc 76mm, 127mm, 254mm, 381mm	4	1	4932480639	4058546409241

1/2" Drive locking extensions

- Knurled locking collar keeps socket securely attached.
- Precision knurling located on the shaft and female drive end for better control when hand threading.
- Chrome finish for corrosion and rust protection.
- Laser engraved size ID for quick and easy identification.
- Sizes available: 76mm, 127mm, 254mm.



Description	Pack quantity	Min. order quantity	Article Number	EAN Code
1/2" Drive 76mm locking extension	1	1	4932480936	4058546412210
1/2" Drive 127mm locking extension	1	1	4932480937	4058546412227
1/2" Drive 254mm locking extension	1	1	4932480938	4058546412234
3pc 1/2" Drive locking extension set 76mm, 127mm, 254mm	3	1	4932480645	4058546409302

1/2" Drive wobble extensions

- Wobble functionality provides additional access in tight spaces and can also be used as a standard extension when fully inserted.
- Precision knurling located on the shaft and female drive end for better control when hand threading.
- Chrome finish for corrosion and rust protection.
- Laser engraved size ID for quick and easy identification.



Description	Pack quantity	Min. order quantity	Article Number	EAN Code
1/2" Drive 76mm wobble extension	1	1	4932480927	4058546412128
1/2" Drive 127mm wobble extension	1	1	4932480928	4058546412135
1/2" Drive 254mm wobble extension	1	1	4932480929	4058546412142
3pc 1/2" Drive wobble extension set 76mm, 127mm, 254mm	3	1	4932480642	4058546409272

1/2" drive breaker bar

- Provides Extra leverage for tougher bolts.
- 180° swiveling head.



Description	Total length (mm)	Total length (inch)	Article Number	EAN Code
1/2" drive breaker drive (15)	380	15	4932471866	4058546297657
1/2" drive breaker drive (24)	610	24	4932471867	4058546297664

1/2" Drive bit holder

- Spring collar to securely hold bits.
- Chrome finish for improved rust protection.
- 1/4" Hex bit reception to work with the most common bit sizes.



Description	Pack quantity	Min. order quantity	Article Number	EAN Code
1/2" Drive Bit Holder for 1/4" Hex Bits	1	1	4932493963	4058546511234

T-bar handle with swivel socket hex metric

- 180° Durable swiveling socket for best access hard-to-reach angles.
- Sliding handle bar to optimal adjust to different positions for more leverage or narrow spaces.
- Shallow sockets to allow fastening of nuts with longer bolts.
- Available sizes: 6-22mm, 24mm.
- Available sets: 7pc.



Description	Pack quantity	Min. order quantity	Article Number	EAN Code
T-bar handle with swivel socket hex 6mm	1	1	4932492675	4058546475468
T-bar handle with swivel socket hex 7mm	1	1	4932492676	4058546475475
T-bar handle with swivel socket hex 8mm	1	1	4932492677	4058546475482
T-bar handle with swivel socket hex 9mm	1	1	4932492678	4058546475499
T-bar handle with swivel socket hex 10mm	1	1	4932492679	4058546475505
T-bar handle with swivel socket hex 11mm	1	1	4932492680	4058546475512
T-bar handle with swivel socket hex 12mm	1	1	4932492681	4058546475529
T-bar handle with swivel socket hex 13mm	1	1	4932492682	4058546475536
T-bar handle with swivel socket hex 14mm	1	1	4932492683	4058546475543
T-bar handle with swivel socket hex 15mm	1	1	4932492684	4058546475550
T-bar handle with swivel socket hex 16mm	1	1	4932492685	4058546475567
T-bar handle with swivel socket hex 17mm	1	1	4932492686	4058546475574
T-bar handle with swivel socket hex 18mm	1	1	4932492687	4058546475581
T-bar handle with swivel socket hex 19mm	1	1	4932492688	4058546475598
T-bar handle with swivel socket hex 20mm	1	1	4932492689	4058546475604
T-bar handle with swivel socket hex 21mm	1	1	4932492690	4058546475611
T-bar handle with swivel socket hex 22mm	1	1	4932492691	4058546475628
T-bar handle with swivel socket hex 24mm	1	1	4932492692	4058546475635
7 pc T-bar handle with swivel socket set 8, 10, 11, 13, 14, 17, 19mm	7	1	4932492674	4058546475451



OUTDOOR HAND TOOLS



Pruning Shear

NEW

- Optimized bypass blade design cuts through branches up to Ø25 mm with ease.
- Steel blades deliver long-lasting, reliable cutting performance.
- Innovative blade assembly withstands high force for smooth cutting of tough branches.
- Two-position lock feature limits max opening for faster cuts and reduced hand fatigue.
- Ergonomic handle design comfortably fits small, medium, and large hand sizes.
- Comfortable dipped grips offer a premium feel in the hand.
- Sizes available: 20 mm, 25 mm.



Description	Max. cutting diameter (mm)	Pack quantity	Min. order quantity	Article Number	EAN Code
25 mm Bypass Pruning Shear	25	1	1	4932498621	4058546524906
20 mm Bypass Pruning Shear	20	1	1	4932498622	4058546524913
Pruning Shear - Replacement Springs (3 pcs)				4932500541	4058546618438

50 mm Bypass Lopper

NEW

- Optimized bypass blade design cuts through branches up to Ø50 mm with ease.
- Forged steel blades deliver long-lasting, reliable cutting performance.
- Lightweight, durable aluminum handles reduce weight without sacrificing strength.
- The robust 690 mm long handles offer high leverage for larger cuts in hardwoods.
- Dual-Grip zones allow users to have different positions to grab.
- Ergonomic rubber overmold handle for maximum grip.



Max. cutting diameter (mm)	Length (cm)	Pack quantity	Min. order quantity	Article Number	EAN Code
50	85	1	1	4932498625	4058546524944

Splitting Axe

NEW

- Precision-beveled blade ensures optimal sharpness for precise, efficient wood splitting
- Forged steel blade for superior strength and long-lasting sharpness.
- Most durable handle with steel reinforcement and a full metal core that resists bending.
- Ergonomic handle with a wear resistant rubber overmold grip for maximum control.
- Includes a sheath for easy transport and safe storage.
- Sizes available for Splitting Axe: 40cm, 66cm, 90cm.
- Sizes available for Splitting Maul: 3.6kg.



Length (cm)	Weight (kg)	Pack quantity	Min. order quantity	Article Number	EAN Code
40	1.1 kg	1	1	4932498628	4058546524975
66	2.7 kg	1	1	4932498629	4058546524982

Pruning Shear Sheath

NEW

- Durable sheath material prevents the blade tip from piercing through.
- Tough hard plastic at front panel for outdoor use.
- Flexible back panel for more wearing comfort on the belt when working.
- Metal belt clip and loop with a maximum height of up to 50 mm, for highest versatility.
- Multi-Fit design for 20 mm and 25 mm pruning shears.



Description	Pack quantity	Min. order quantity	Article Number	EAN Code
Pruning Shear Sheath	1	1	4932498627	4058546524968

Pruning Shear with Sheath

NEW

- Optimized bypass blade design cuts through branches up to Ø25 mm with ease.
- Forged steel blades deliver long-lasting, reliable cutting performance.
- Innovative blade assembly withstands high force for smooth cutting of tough branches.
- Two-position lock feature limits max opening for faster cuts and reduced hand fatigue.
- Ergonomic handle design comfortably fits small, medium, and large hand sizes.
- Comfortable dipped grips offer a premium feel in the hand.
- Includes a Multi-Fit design Pruning Shear Sheath.
- Sizes available: 20 mm, 25 mm.



Max. cutting diameter (mm)	Pack quantity	Min. order quantity	Article Number	EAN Code
20	1	1	4932499680	4058546568443
25	1	1	4932499679	4058546568436

Curved Saw

NEW

- Highly efficient saw blade with Japanese pull cut teeth design for faster cuts and effortless work.
- Cuts through branches of up to Ø200 mm with ease.
- Quadruple-sharpened teeth stay sharp longer for lasting cutting performance.
- Chrome plated blade resists rust, reduces friction, and ensures smoother, longer-lasting performance.
- Ergonomic softgrip design for maximum hand comfort.
- Handle angle optimized to blade position to reduce fatigue when cutting.
- Variable position of the sheath clip for right or left-handers.



Blade length (mm)	Max. cutting diameter (mm)	Pack quantity	Min. order quantity	Article Number	EAN Code
350	200	1	1	4932498623	4058546524920

Curved Folding Saw

NEW

- Highly efficient saw blade with Japanese pull cut teeth design for faster cuts and effortless work.
- Cuts through branches of up to Ø150 mm with ease.
- Quadruple-sharpened teeth stay sharp longer for lasting cutting performance.
- Chrome plated blade resists rust, reduces friction, and ensures smoother, longer-lasting performance.
- Ergonomic softgrip design for maximum hand comfort.
- Handle angle optimized to blade position to reduce fatigue when cutting.
- Variable locking position of the saw blade for regular straight cuts or angled cuts in confined areas.
- Different grip positions to reach further or closer branches.
- Folding design for safe, pocket-sized portability.



Blade length (mm)	Max. cutting diameter (mm)	Pack quantity	Min. order quantity	Article Number	EAN Code
250	150	1	1	4932498624	4058546524937

Pole Saw & Pruner

NEW

- 2-IN-1 — Saw & Pruner combines two tasks in one tool, saving time by eliminating the need to switch tools.
- Saw blade cuts through branches of up to Ø180 mm with ease.
- Integrated pruner with rope pull mechanism for cutting thinner branches of up to Ø30 mm with ease.
- Quadruple-sharpened saw blade teeth stay sharp longer for lasting cutting performance.
- Chrome plated saw blade resists rust, reduces friction, and ensures smoother, longer-lasting performance.
- Telescopic full-aluminum pole, 2,1 m long in its standard position, built for maximum durability.
- Extendable up to 4.9 m for cutting high branches safely from the ground.
- Softgrip handle design for maximum hand comfort.
- Optimized ergonomics with an oval-shaped pole for improved grip and better control.
- Quick and easy replacement of the saw blade.

Blade length (mm)	Max. cutting diameter (mm)	Pack quantity	Min. order quantity	Article Number	EAN Code
330	180	1	1	4932498626	4058546524951



2.3 kg Splitting Wedge

NEW

- Side Wings boost efficiency by forcing wood apart faster and more splitting control for large, tough logs.
- Fully corrosion resistant coating for long-lasting blade sharpness.
- Large strike face for maximum impact surface and more efficiency.
- 200 mm long and 2.3 kg heavy body made of forged steel for exceptional durability and strength.



Weight (kg)	Pack quantity	Min. order quantity	Article Number	EAN Code
2.3	1	1	4932500679	4058546619817

Pole Saw & Pruner - Replacement Saw Blade

NEW

- Quick and easy replacement of the saw blade for the Pole Saw & Pruner.
- Cuts through branches of up to Ø180 mm with ease.
- Quadruple-sharpened saw blade teeth stay sharp longer for lasting cutting performance.
- Chrome plated saw blade resists rust, reduces friction, and ensures smoother, longer-lasting performance.



Blade length (mm)	Pack quantity	Min. order quantity	Article Number	EAN Code
330	1	1	4932500540	4058546618421

TRADE SETS



PACKOUT™ Electrician Set 62pcs

NEW

- PACKOUT™ compatible - provides highest levels of durability and tool protection.
- Most innovative inlay design - Clamps the tools and holds them in place for optimal organization.
- Uniform appearance and premium handtools.
- Multiple Inlays & Dividers - suited & unlimited configuration with extra space for favorite hand tools.
- Insulated pliers - VDE certified, Steel blades are fully forged, hardened and tempered for best durability.
- Tri lobe screwdriver - Slim shank diameter for access to low lying screw applications, VDE certified.
- 1/4in Ratchet Driver & Socket set - Ratchet with 90 tooth design and 4° of arc swing, ideal for tight work spaces.
- Automatic Wire Stripper - Fully automatic, self-adjusting wire stripper for all common stranded and solid wires from 0.2 squaremm to 16 squaremm.



Description	Pack quantity	Min. order quantity	Article Number	EAN Code
PACKOUT™ Electrician Set 62pcs	62	1	4932499466	4058546566302
<p>VDE Diagonal Cutter 160mm, VDE Heavy Duty Diagonal Cutter 200mm, VDE Long 45deg. Round Nose Pliers 205mm, VDE Combination Plier 180mm, VDE Water pump plier 240mm, Tri-Lobe VDE Screwdriver 0.4X2.5X75, Tri-Lobe VDE Screwdriver 0.6X3.5X100, Tri-Lobe VDE Screwdriver 1.2X6.5X150, Tri-Lobe VDE Screwdriver PZ/SL1 X80, Tester 0.5X3X65, Cable Stripper, Hex Key 9pc Set, Hickory Engineers Hammer 300g, Level Handy 10 cm, Fastback Flip Utility Knife With Blade Storage, Automatic Wire Stripper, 1/4in Ratchet Driver+Socket set 38pc</p>				

PACKOUT™ Plumbing Set 74pcs

NEW

- PACKOUT™ compatible - provides highest levels of durability and tool protection.
- Most innovative inlay design - Clamps the tools and holds them in place for optimal organization.
- No Brand Mix - Uniform appearance and premium handtools.
- Multiple Inlays & Dividers - suited & unlimited configuration with extra space for favorite hand tools.
- VDE pliers - VDE certified, Steel blades are fully forged, hardened and tempered for best durability.
- Tri lobe Demolition screwdriver - Hammer ready strike caps.
- Maxbite Rat Met Comb Spanners -144 Ratcheting teeth positions giving 2.5° arc swing allowing access in tighter space.
- 1/4in Ratchet Driver & Socket set - Ratchet with 90 tooth design and 4° of arc swing, ideal for tight work spaces.
- Tubing Cutter 42mm- 4 roller design delivers accurate cuts and prevents walking.



Description	Pack quantity	Min. order quantity	Article Number	EAN Code
PACKOUT™ Plumbing Set 74pcs	74	1	4932499467	4058546566319
<p>VDE Diagonal Cutter 160mm, VDE Heavy Duty Diagonal Cutter 200mm, VDE Long Round Nose Pliers 205mm, VDE Combination Plier 180mm, Adjustable Water pump plier 250mm, 4in1 Multi-Purpose Stripper, Tri-Lobe VDE Screwdriver 0.4X2.5X75, Tri-Lobe VDE Screwdriver 0.6X3.5X100, Tri-Lobe VDE Screwdriver 1.2X6.5X150, Tri-lobe Demolition Screwdriver Set, Tester 0.5X3X65, Maxbite Rat Met Comb Span 10mm, Maxbite Rat Met Comb Span 13mm, Maxbite Rat Met Comb Span 17mm, Maxbite Rat Met Comb Span 19mm, Fiberglass Engineers Hammer 300g, 1/4in Ratchet Driver+Socket set 38pc, Fastback Flip Utility Knife With Blade Storage, Hex Key 9pc Set, Folding Torx Key 8pc Set, Tube Cutter 3.2-42mm</p>				

PACKOUT™ Electrician Box

NEW

- PACKOUT™ compatible - provides highest levels of durability and tool protection
- Most innovative inlay design - clamps the tools and holds them in place for optimal organization
- Multiple inlays & dividers - allows suited & unlimited configuration with lots of space for favorite handtools



Description	Pack quantity	Min. order quantity	Article Number	EAN Code
PACKOUT™ Electrician Box	1	1	4932499703	4058546568672

PACKOUT™ Plumbing Box

NEW

- PACKOUT™ compatible - provides highest levels of durability and tool protection
- Most innovative inlay design - clamps the tools and holds them in place for optimal organization
- Multiple inlays & dividers - allows suited & unlimited configuration with lots of space for favorite handtools



Description	Pack quantity	Min. order quantity	Article Number	EAN Code
PACKOUT™ Plumbing Box	1	1	4932499704	4058546568689



STAY SAFE.
STAY PRODUCTIVE.

SAFETY. TAKEN SERIOUSLY.

By designing cordless tools without compromise, and creating a range of PPE designed around user needs, at MILWAUKEE®, we're making the jobsite safer and more productive every day.

Today, we're proud to boast over 215 Cordless Tools on our M18™ platform and over 95 Cordless Tools on our M12™ platform, eliminating trip hazards from the jobsite. We've redefined the light equipment market with the launch of our MX Fuel™ range, preventing the need for petrol on the jobsite with the launch of key tools including the 350mm Cut Off Saw, and Cordless Breaker.

Personal Protective Equipment has seen little innovation over the years, driving users to modify their gear to better meet their needs. By taking time to understand our users' needs, we have developed PPE from the ground up, enabling users to adapt to each job. This has paved the way for innovative solutions such as our new safety glasses that can be worn all day with lasting, fog-free lenses.

MILWAUKEE® is committed to creating innovative solutions that help users stay safe and stay productive on the jobsite.

SAFETY GLASSES
USING THE CORRECT
EYE PROTECTION
COULD REDUCE THE SEVERITY OR PREVENT
90%
OF JOBSITE EYE INJURIES

(preventblindness.org, 2019)

GLOVES
70%
OF WORKERS
WHO EXPERIENCED
HAND INJURIES
WERE NOT WEARING
THE CORRECT GLOVES

(Manufacturing.net, 2019)

LANYARDS
A FALLING OBJECT
IS THE **3RD**
HIGHEST CAUSE OF
FATALITY
ON A JOBSITE

(Peoplesafe.co.uk, 2019)

UNDERSTANDING THE GUIDANCE



STAY SAFE.
STAY PRODUCTIVE.

HEAD PROTECTION STANDARDS

EN397: EN12492 HEAD PROTECTION

EN397 is a European standard that sets out the requirements for industrial safety helmets. The standard applies to helmets intended to provide protection against falling objects and other types of head impact in industrial settings.

The EN397 standard specifies a number of requirements that a helmet must meet to be considered suitable for industrial use. These requirements include:

1. Resistance to impact: The helmet must be able to withstand a specified level of impact energy without breaking or deforming.
2. Penetration resistance: The helmet must be able to resist the penetration of objects that may strike the head, such as nails, screws or sharp objects.
3. Shock absorption: The helmet must be designed to absorb the force of an impact and distribute it evenly across the head.
4. Retention system: The helmet must have a chin strap or other retention system to keep it securely on the head.
5. Field of vision: The helmet must provide an adequate field of vision for the wearer.
6. Resistance to flame: The helmet must not ignite or continue to burn after exposure to a flame.
7. Electrical insulation: The helmet must provide protection against electric shocks.

EN397 is one of the most widely recognized standards for industrial safety helmets in Europe and is often used as a basis for certification and testing by third-party organizations.



EN12492

EN12492 is a European standard that sets out the requirements for mountaineering helmets. The standard applies to helmets intended to provide protection against impacts, penetration, and lateral deformation for mountaineers, rock climbers, and other vertical activities.

The EN12492 standard specifies a number of requirements that a helmet must meet to be considered suitable for mountaineering use. These requirements include:

1. Resistance to impact: The helmet must be able to withstand a specified level of impact energy without breaking or deforming.
2. Penetration resistance: The helmet must be able to resist the penetration of objects that may strike the head, such as rocks or ice.
3. Retention system: The helmet must have a chin strap or other retention system to keep it securely on the head during an impact.
4. Lateral deformation: The helmet must be designed to prevent excessive lateral deformation during an impact, which can cause injury to the neck or brain.
5. Field of vision: The helmet must provide an adequate field of vision for the wearer.
6. Ventilation: The helmet must have sufficient ventilation to prevent overheating during physical activity.
7. Compatibility with other equipment: The helmet must be compatible with other equipment, such as goggles or headlamps.
8. Durability: The helmet must be designed to withstand normal wear and tear associated with mountaineering activities.

STANDARDS	FORCE TRANSMISSION (TOP)	PENETRATION (TOP)	FORCE TRANSMISSION (SIDE, FRONT, REAR)
EN397	<p>49J</p> <p>5KG 1M</p> <p>MAX FORCE: 5.000N</p>	<p>29J</p> <p>3KG 1M</p>	-
EN12492	<p>100J</p> <p>5KG 2M</p> <p>MAX FORCE: 10.000N</p>	<p>29J</p> <p>3KG 1M</p>	<p>25J</p> <p>5KG 0.5M</p> <p>MAX FORCE: 10.000N</p>

To meet the EN12492 standard, a helmet must undergo a series of tests, including an impact test, a penetration test, and a retention system test. The helmet is also tested for lateral deformation, field of vision, and ventilation. EN12492 is one of the most widely recognized standards for mountaineering helmets in Europe and is often used as a basis for certification and testing by third-party organizations.

EN 50365

EN 50365 is the European standard for electrically insulating helmets used for electrical work up to 1,000 volts AC or 1,500 volts DC. It dictates the necessary design, material, and testing requirements to ensure the wearers safety. Compliance with this standard is crucial for protecting individuals working in electrical environments.

MILWAUKEE®'s BOLT 100 hard hat and BOLT 200 helmet fully comply with EN 50365, and is certified for use up to 1000V A.C. and 1500V D.C. in both vented and unvented versions.

SAFETY GLASSES

EN 166:2001 PERSONAL EYE-PROTECTION

The EN 166 standard specifies requirement for personal eye-protectors, used to combat various hazards as encountered across numerous industries which are likely to damage the eye or impair vision. The EN 170 standard specifies requirements for ultraviolet filters, while EN 172 refers to the sun glare filtration for industrial use.

All MILWAUKEE® safety glasses are certified according to EN 166, to guarantee the eye protection and the resistance to impact. The clear safety glasses are EN 170 certified, to offer an UV protection, even with clear lenses, while the tinted and polarised safety glasses are EN 172 certified to offer a solar protection, ideal for the jobsite and also during leisure time.

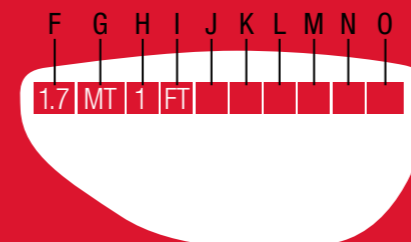

- 2C-1.2 MT 1FT CE
- 2 = EN 170 (UV filters standard)
- C = Unimpaired color (clear lenses)
- 1.2 = Protection level (1.2 is the lightest)
- MT = MILWAUKEE® Tool
- 1 = Optical class (avoid dizziness)
- F = Impact resistance
(only F can apply to safety glasses, A & B are for safety goggles)
- T = Extreme temperatures resistance (-5° / +55°)
- K = Anti-scratch
- N = Anti-Fog
- CE = European Certification

Same frame marking for all 6 SKUs

- **MT 166 FT CE**
- MT = MILWAUKEE® Tool
- 166 = Name of the EN standard
- F = Impact resistance
(only F can apply to safety glasses, A & B are for safety goggles)
- T = Extreme temperatures resistance (-5° / +55°)
- CE = European Certification

HEARING PROTECTION

Hearing protection is crucial on the jobsite to prevent hearing damage from excessive noise exposure. It maintains worker safety, concentration, and productivity. Prioritizing hearing protection safeguards workers' long-term hearing health from permanent damage that may occur and creates a safer work environment.

The EN 352 standard that all MILWAUKEE® hearing protection products meet, provides workers with the protection they need to Stay Safe and Stay Productive on the jobsite.

EN 352-2:2020 HEARING PROTECTORS: EARPLUGS

The EN 352-2 standard regulates earplugs that are inserted directly into the ear canal. The standard ensures the earplugs are made with appropriate materials, designed for comfort and effectiveness, meet performance benchmarks, carry necessary markings, and provide clear instructions for users. Adhering to this standard promotes the safety and reliability of earplugs for protecting hearing in noisy environments.

When noise exceeds 85 dB on the jobsite, it is mandatory for employers to provide hearing protection that meets these requirements. All MILWAUKEE® earplugs that are inserted into the ear canal fully meet the EN 352-2 standards and protect workers from long term damage.

Hearing protection is mandatory when noise exceeds 85 dB (upper action level).

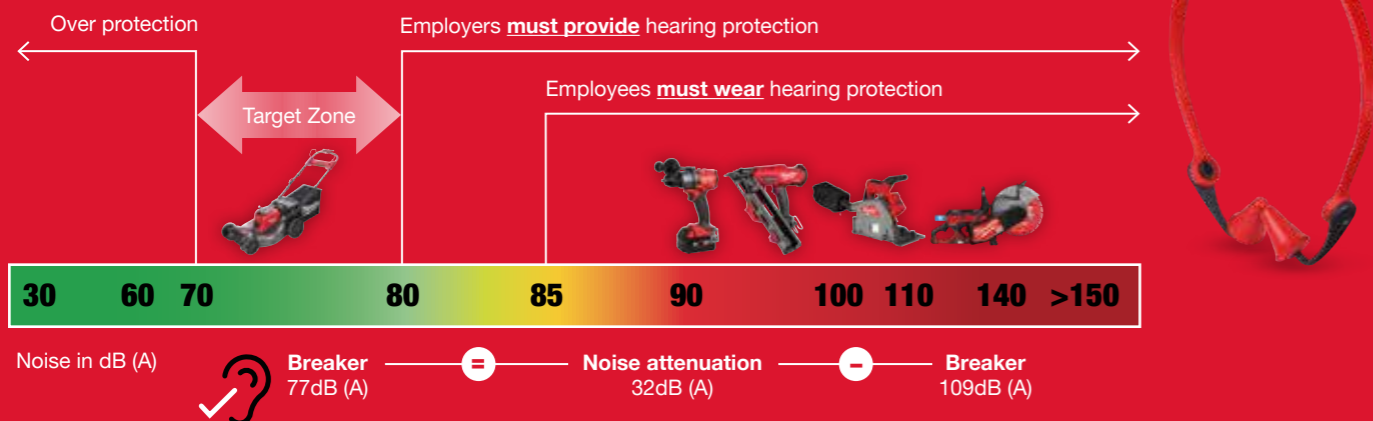

SNR (Single Number Rating) = attenuation in dB
H/M/L = High-/ Medium-/Low-frequency attenuation value

Noise – SNR = residual noise level
Higher SNR or H/M/L value = higher noise attenuation

The REDLITHIUM USB™ Jobsite Earbuds feature advanced technology that not only meets the EN 352-2 standards but also provides additional functionalities for the modern jobsite. Jobsite Awareness Mode ensures that users can safely hear necessary environmental sounds while being protected from harmful noise levels. When fully charged, the earbuds provide up to 10 hours of continuous use, with an additional 70 hour's run time from the case. The earbuds are designed to limit entertainment audio signals to a safe level of 82 dB(A), particularly for Bluetooth A2DP, HFP, and HSP inputs, thereby preventing overexposure to high volume levels that can damage hearing.

To maintain their effectiveness, the foam inserts should be regularly inspected for any signs of wear and tear, such as deterioration or cracking, and cleaned with a damp cloth. It is recommended to replace the inserts periodically to ensure optimal performance and hygiene.

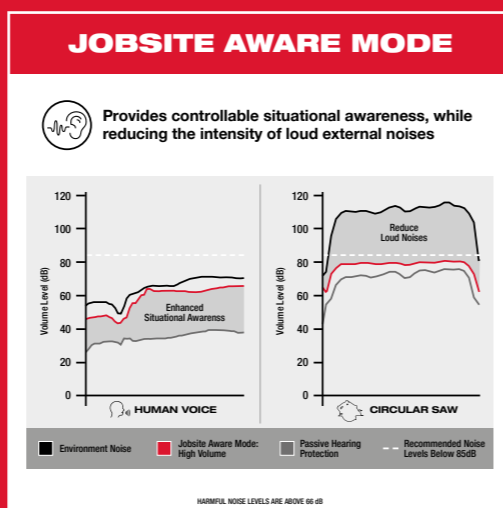

EN 352-2:2020 HEARING PROTECTORS: EAR MUFFS

EN 352-3 is a standard for earmuffs designed to be mounted on protective helmets or head/face protection devices. The standard ensures compatibility, effectiveness, and safety by specifying materials, secure fit, noise reduction, compliance markings, and user instructions. Adhering to EN 352-3 guarantees reliable hearing and head/face protection in hazardous environments.

All MILWAUKEE® ear muffs that are attached to protective hard hats/helmets fully meet the EN 352-3 standards.



HAND PROTECTION

EN 388:2016 PROTECTIVE GLOVES AGAINST MECHANICAL RISKS



The EN 388 standard specifies requirements, test methods, marking and information to be supplied for protective gloves against the mechanical risks of abrasion, blade cut, tear, puncture and, if applicable, impact.

The impact protection has to fully encompass the back of hand, including the fingers. This standard is intended to be used in conjunction with EN ISO 21420.

All MILWAUKEE® hand protection solutions are certified according to both EN ISO 21420 and EN 388 standards, the rating given varies for each type of gloves. EN ISO 21420 is the European general requirement and test method standard for protective gloves.



	Rating
Abrasion	1-4
Cut (Coup Test)	1-5
Tear	1-4
Puncture	1-4
Cut (TDM-100 Test)	A-F
Impact Protection	P,F

X= Not tested P= Pass F= Fail

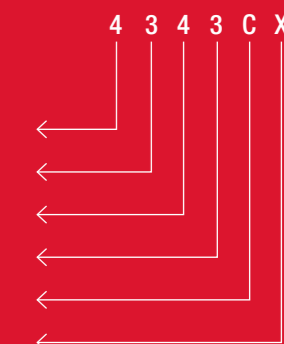

WINTER GLOVES

EN 511:2006 PROTECTIVE GLOVES AGAINST COLD



The EN 511 standard specifies the requirements and test methods for protective gloves against convective cold or contact cold down to - 50 ° C solid.

The cold can vary with the climatic conditions or one professional activity. This standard is intended to be used in conjunction with EN 388 and EN ISO 21420.



	Min – Max
Convective Cold	0-4
Contact Cold	0-4
Water Permeability	0-1

X= Not tested

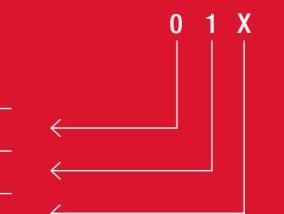

CHEMICAL GLOVES

EN ISO 374-1: 2016 PROTECTIVE GLOVES AGAINST DANGEROUS CHEMICALS AND MICRO-ORGANISMS



The EN ISO 374-1:2016 standard specifies the requirements for gloves designed to protect against dangerous chemicals and micro-organisms. This includes protection through resistance to degradation, permeation, and penetration by chemicals. Gloves must meet key performance criteria, such as resistance to chemical exposure and maintaining material integrity.

Chemicals can penetrate through defects in the glove material, such as holes. Degradation occurs when the glove material is negatively impacted by chemical contact, and the degradation percentage must be included in the user instructions. Permeation refers to chemicals breaking through the glove material at a molecular level, and gloves are tested to ensure they meet minimum breakthrough times.

Type A gloves must withstand a breakthrough time of at least 30 minutes against 6 or more test chemicals. Type B gloves must meet the same time requirement for at least 3 test chemicals, and Type C gloves must withstand 10 minutes for at least 1 test chemical.

HEAT PROTECTION EN 407

EN ISO 21420 AND EN 407 PROTECTION AGAINST THERMAL RISKS

The EN 407 standard specifies requirements, test methods, marking, and information to be supplied for protective gloves that provide protection against thermal risks such as heat and/or fire.

It covers performance for burning behavior, contact heat, convective heat, radiant heat, small splashes of molten metal, and large quantities of molten metal. Gloves certified under this standard are designed to ensure the user's hands are protected against various heat-related hazards depending on the application.

This standard is intended to be used in conjunction with EN ISO 21420, which defines the general requirements and test methods for protective gloves.

All MILWAUKEE® hand protection solutions that address thermal risks are certified according to both EN ISO 21420 and EN 407 standards, with the rating varying for each type of glove.

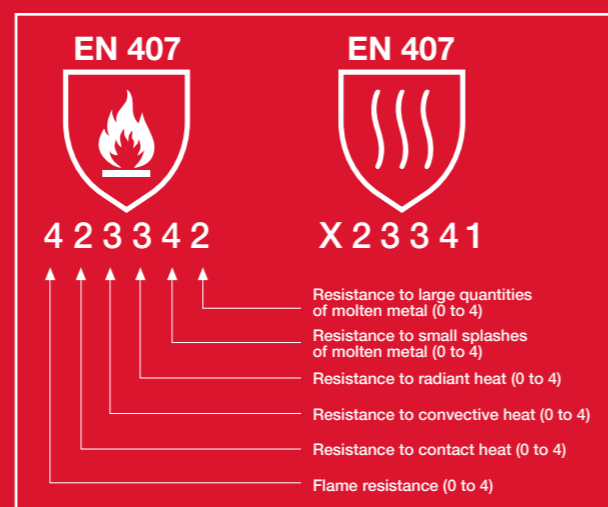

HIGH VISIBILITY

EN ISO 20471:2013 HIGH VISIBILITY CLOTHING



The EN ISO 20471 standard specifies requirements for high visibility clothing to ensure it is capable of visually signalling the user's presence. High visibility clothing ensures the user can be seen in all light conditions and is divided into 3 performance classes depending on the requirements.

The MILWAUKEE® high visibility vests are intended for multiple applications and are class 2 certified.

	Class 1	Class 2	Class 3
Reflective Tape	0.10 sqm	0.13 sqm	0.20 sqm
Fluorescent Material	0.14 sqm	0.50 sqm	0.80 sqm
Level of visibility	Lowest	Intermediate	Highest

RIS-3279-TOM (ONLY ORANGE CONTRACTOR HI-VIS VEST)



RIS-3279-TOM (formerly GO-RT 3279) is a high visibility standard specifically for the UK rail industry, unlike the broader EU-wide EN standards. Its purpose is to ensure rail workers near tracks are highly visible to approaching trains or other traffic. The standard requires compliance with color specifications in BS EN 20471 clause 5.1.2 to ensure a specific orange shade, avoiding red hues. The exact chromaticity coordinates for the fluorescent orange color are X: 0.588, Y: 0.371, with a luminance factor of at least 0.4. While the color tolerance follows EN 20471, there is no tolerance for the luminance factor.

	Class 1	Class 2	Class 3
Reflective Tape	0.10 sqm	0.13 sqm	0.20 sqm
Fluorescent Material	0.14 sqm	0.50 sqm	0.80 sqm
Level of visibility	Lowest	Intermediate	Highest

CLOTHING

EN 13758-1:2001 TEXTILES - SOLAR UV PROTECTIVE PROPERTIES - PART 1: METHOD OF TEST FOR CLOTHING FABRICS

The EN 13758-1 standard specifies the requirements and test methods for clothing designed to offer ultraviolet (UV) protection. This standard ensures that the clothing fabric meets the criteria for UV protection and is capable of effectively blocking harmful UV rays, with a rating of UPF50+ (all MILWAUKEE® EN 13758-1 certified products carry a UPF50+ rating). This standard is intended to be used in conjunction with other relevant textile and clothing standards to ensure comprehensive protection and performance.

MILWAUKEE® products that hold the EN 13758 certification are: PVA Cooling Towel and Cooling Microfiber Towel, Skull Cap, Work T-Shirts, Warm Weather T-Shirts, Baseball Caps, Performance Caps, Red Performance Neck Gaiters.



KNEE PADS

Wearing knee protection on the jobsite is important for several reasons:

- Reduce the risk of knee injuries: Knee pads reduce the risk of knee injuries that occur from kneeling and crawling. This can help prevent long-term damage to the knees, such as joint pain, arthritis, and other knee-related conditions.
- Increase comfort and productivity: Knee protection helps to reduce the discomfort and fatigue that can occur from working on hard surfaces or kneeling for long periods.
- Meet safety regulations: In many industries and job sites, knee protection is required by law or industry standards to ensure worker safety. Wearing knee protection can help ensure compliance with these regulations and prevent penalties for non-compliance.

EN 14404:2004+A1:2010 KNEE PROTECTORS FOR WORK WHEN KNEELING



In Europe, the most commonly recognized knee protection standard for workers on job sites is EN 14404:2004+A1:2010. This standard specifies the requirements and test methods for knee protectors used in tasks where the user is frequently kneeling. The standard covers the design, construction, performance, and marking of knee protectors, and it is applicable to all types of knee protectors used in occupational environments, including those worn over or integrated into clothing. Knee pads are tested based on their impact absorption, pressure distribution of the entire surface and protection against penetration of sharp or pointy objects.

EN 14404:2004+A1:2010 is recognized throughout the European Union and is widely used by manufacturers, employers, and workers to ensure that knee protectors provide the necessary level of protection and performance for workers who kneel frequently as part of their job duties.



Type 1	Knee pads independent of other clothing, fastened around the legs
Type 2	Knee pads in foam or other padding, secured in pockets on the legs, or which is permanently attached to the pants.
Type 3	Knee pads not stuck to the body but placed in position as the user moves around.
Type 4	Knee pads, which is part of a unit with additional functions, such as the framework for support to stand up, or kneeling seat. Can be worn on the body, or be independent.



Protection Class 0	Flat floor surfaces
Protection Class 1	Flat or uneven floor surface. Protects against penetration by a force of at least (100 ± 5) N
Protection Class 2	Flat or uneven floor surfaces under severe conditions. Protects against penetration by a force of at least (250 ± 10) N



SAFETY FOOTWEAR

EN ISO 20345:2022 SAFETY FOOTWEAR



The EN ISO 20345:2022 standard outlines the requirements for safety footwear designed for general use. This includes protection against mechanical risks, slip resistance, thermal hazards, and ergonomic performance. Safety footwear must meet all fundamental criteria, such as measurements, construction quality, material durability, and resistance to external factors.

Depending on the specific hazards in the workplace, additional requirements may be necessary. In these cases, the footwear must meet the relevant additional standards and be appropriately marked. Each MILWAUKEE® shoe's specific performance ratings are indicated on the tongue label and the shoe box sticker.

Class I	Footwear made entirely from leather and other materials	P	(Metal insert type P) Penetration resistant outsole: Lowest penetration value required shall not be less than 1100N
Class II	All entirely moulded footwear	PL	(Non-metallic insert type PL) Penetration resistant outsole: Average penetration force shall not be lower than 1100 N and no single value must be lower than 950 N
SBH	Hybrid footwear that cannot be classed as either I or II.	PS	(Non-metal insert type PS) Penetration resistant outsole: Average penetration value shall not be less than 1100N
SB	Safety toe cap protection only, tested with 200 J impact and 15 kN compression force.	A	Anti-static: Electrical resistance between foot and ground of between 0.1 and 1000 Mega Ohms*
S1	Class 1 + Closed heel area + SB + A + E	C	Partially conductive footwear. The electrical resistance shall not be greater than 0.1 Mega Ohms between foot and ground*
S2	As S1 + WPA	CI	Insulation against cold: 30 minutes at -17°C, the decrease shall not be more than 10°C
S3	(Metal insert type P) as S2 + P + Cleated Outsole	HI	Insulation against heat: 30 minutes at 150°C, the rise shall not be higher than 22°C
S3L	(Non-metal insert type PL) as S2 + PL + Cleated Outsole	E	Energy absorption of the seat region: Energy absorbed to be not less than 20J
S3S	(Non-metal insert type PS) as S2 + PS + Cleated Outsole	WPA	Water penetration and absorption (water resistant and breathable)
S4	Upper material of all Rubber or Polymeric as SB + Closed heel area + A + E	AN	Ankle protection: 10N impact means transferred force shall not exceed 10KN and no single value shall exceed 15KN
S5	(Metal insert type P) as S4 + P + Cleated Outsole	WR	Water resistant footwear (waterproof membrane)
S5L	(Non-metal insert type PL) as S4 + PL + Cleated Outsole	CR	Cut resistant upper: Cut resistance to exceed 2.5 on the index
S5S	(Non-metal insert type PS) as S4 + PS + Cleated Outsole	M	Metatarsal protection 100J impact energy
S6	As S2 + WR	SR	SR slip resistance test features glycerine on ceramic tile surface. Replaces SRA SRB SRC.
S7	(Metal insert type P) as S3 + WR	Ø	No test given – for footwear featuring spikes or studs on sole.
S7L	(Non-metal insert type PL) as S3 + WR		
S7S	(Non-metal insert type PS) as S3 + WR		
HRO	Heat resistant outsole compound: Shall withstand 300°C for 60 seconds.		
FO	Resistance to fuel oil		
LG	Ladder grip		
SC	Scuff cap abrasion		

ADAPT TO YOUR JOBSITE

The new MILWAUKEE® BOLT Helmets and Bolt Accessories allow each user to tailor their Head protection to best meet the demands of the jobsite.

BOLT™ 1000

INDUSTRIAL
HARD
HAT

BOLT™ 2000

WORKING
AT HEIGHT
HELMET

COLOURS
AVAILABLE



ABS SHELL
LIGHTWEIGHT

**ELECTRICALLY
INSULATED**

For use on low voltage installations EN50365.

**PREMIUM
RATCHET**

LEXAN SHELL
SUPERIOR IMPACT RESISTANCE

**INNER FOAM
TECHNOLOGY**

Foam progressively stiffens when impacted; distributes pressure evenly across entire head when impacts, independent of impact location.

**ADJUSTABLE
CHIN STRAP**

COLOURS
AVAILABLE

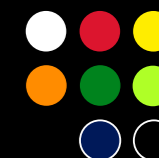

BOLT™
ACCESSORIES

ATTACHMENTS

MULTI ACCESSORIES COMPATIBILITY

Across BOLT 100 and BOLT 200 products



BOLT™ Visor
Universal Tinted
4932479942
Universal Clear
4932479941



**BOLT™ Mesh Face
Shield Universal**
4932479940



BOLT™ Face Shield
Universal Clear
4932479939
Universal Tinted
4932479938



**BOLT™ Contractor
Face Shield**
4932498237



**BOLT™
Sunshade Yellow**
4932492101



BOLT™ Headlamp
4933479902



**BOLT™ LP
Earmuffs**
4932478878



**BOLT™ HP
Earmuffs**
4932478877

VENTED

ITEM NO.	DESCRIPTION	
4932478122	BOLT 100 White Vented	●
4932478913	BOLT 100 Yellow Vented	●
4932478916	BOLT 100 Red Vented	○
4932478917	BOLT 100 Black Vented	●
4932478914	BOLT 100 Blue Vented	●
4932478915	BOLT 100 Green Vented	●
4932480663	BOLT 100 Orange Vented	●
4932480664	BOLT 100 Hi Vis Vented*	●

UNVENTED

ITEM NO.	DESCRIPTION	
4932479246	BOLT 100 White Unvented	●
4932479247	BOLT 100 Yellow Unvented	●
4932479250	BOLT 100 Red Unvented	○
4932479251	BOLT 100 Black Unvented	●
4932479248	BOLT 100 Blue Unvented	●
4932479249	BOLT 100 Green Unvented	●
4932480665	BOLT 100 Orange Unvented	●
4932480666	BOLT 100 Hi Vis Unvented*	●

VENTED

ITEM NO.	DESCRIPTION	
4932478141	BOLT 200 White Vented	●
4932478918	BOLT 200 Yellow Vented	●
4932478919	BOLT 200 Red Vented	○
4932478920	BOLT 200 Black Vented	●
4932480651	BOLT 200 Blue Vented	●
4932480652	BOLT 200 Green Vented	●
4932480653	BOLT 200 Orange Vented	●
4932480654	BOLT 200 Hi Vis Vented*	●

UNVENTED

ITEM NO.	DESCRIPTION	
4932479252	BOLT 200 White Unvented	●
4932479253	BOLT 200 Yellow Unvented	●
4932479254	BOLT 200 Red Unvented	○
4932479255	BOLT 200 Black Unvented	●
4932480655	BOLT 200 Blue Unvented	●
4932480656	BOLT 200 Green Unvented	●
4932480657	BOLT 200 Orange Unvented	●
4932480658	BOLT 200 Hi Vis Unvented*	●

BOLT™ CUSTOMISATION



CUSTOMISE
YOUR BOLT™ 200 HELMET



CUSTOMISE
YOUR BOLT™ 100 HARD HAT



PRINT CAPABILITIES

- 4 printing zones
- Digital / laser printing
- Text printing
- No colour limitation for logos or images

ORDER INFORMATION

- MOQ: BOLT™ 100= 25pc / BOLT™ 200= 24pc
- Delivery time: 2-3 weeks after order confirmation
- Request more information from local MILWAUKEE® sales representative

INTERACTIVE

Real-time design



ADD YOUR LOGO

Most file types accepted

1. Upload the logos to the online visualiser and view your customised helmet in 3D.
2. Contact your MILWAUKEE® sales representative to confirm the order through the online Order Portal with the corresponding MILWAUKEE® Dealer.
3. Sign the proofing document provided via the online Order Portal.
4. Follow up on the status via the online Order Portal with your dealer.

FRONT



BACK



SAFETY HELMET / HARD HAT LOGO PLACEMENT

LEFT



RIGHT



BOLT™ 100

- BOLT™ system – ensure compatibility among a large range of accessories with an easy and intuitive attachment system.
- Extremely comfortable and easy to adjust wheel ratchet adjustment system.
- Shell made of ABS for light weight.
- 6 points suspension for more comfort.
- Changeable and comfortable sweatband.
- Size: 52 - 68 cm.
- 8 colours available with glossy finish: white, yellow, orange, red, black, green, blue and high visibility yellow.
- Certified as per EN 397:2012 with optional requirement for Multi Metal, extreme temperatures -30°C, Lateral Deformation, and Electrical insulation 440 V a.c. (electrical insulation 440V under EN397 just on the unvented version).
- Certified as per EN 50365:2002 Electrical class 0 for installations with nominal voltage up to 1000V A.C. and 1500V D.C. in vented and unvented version.



Description	Pack quantity	Min. order quantity	Article Number	EAN Code
BOLT™ 100 White Vented - 1pc	1	1	4932478122	4058546340551
BOLT™ 100 Yellow Vented - 1pc	1	1	4932478913	4058546361952
BOLT™ 100 Blue Vented - 1pc	1	1	4932478914	4058546361969
BOLT™ 100 Green Vented - 1pc	1	1	4932478915	4058546361976
BOLT™ 100 Red Vented - 1pc	1	1	4932478916	4058546361983
BOLT™ 100 Black Vented - 1pc	1	1	4932478917	4058546361990
BOLT™ 100 Black Vented - 1pc	1	1	4932480663	4058546409487
BOLT™ 100 Hi-Vis Yellow Vented - 1pc	1	1	4932480664	4058546409494

Description	Pack quantity	Min. order quantity	Article Number	EAN Code
BOLT™ 100 White Unvented - 1pc	1	1	4932479246	4058546370404
BOLT™ 100 Yellow Unvented - 1pc	1	1	4932479247	4058546370411
BOLT™ 100 Blue Unvented - 1pc	1	1	4932479248	4058546370428
BOLT™ 100 Green Unvented - 1pc	1	1	4932479249	4058546370435
BOLT™ 100 Red Unvented - 1pc	1	1	4932479250	4058546370442
BOLT™ 100 Black Unvented - 1pc	1	1	4932479251	4058546370459
BOLT™ 100 Orange Unvented - 1pc	1	1	4932480665	4058546409500
BOLT™ 100 Hi-Vis Yellow Unvented - 1pc	1	1	4932480666	4058546409517

BOLT™ headlamp 600 lumens USB rechargeable

- 600 lumens of multi-directional TRUEVIEW™ high definition light output
- Full BOLT™ compatibility with a low profile design that works with all BOLT™ helmets, visors and face shields
- Mount connects to BOLT™ helmet without straps
- 70° pivoting light head to help users direct light where it is needed most
- 4 modes to manage output or run time with up to 32 hours of run time on (1) USB 3.0 Ah battery
- Fuel gauge allows fast checking of REDLITHIUM™ USB battery charge
- Conveniently charge REDLITHIUM™ USB battery internally with micro-USB Type C cable from USB power source or AC outlet (wall plug not included)
- IP54 rating, light is protected from dust and falling water
- Jobsite tough micro-USB braided cable with metal ends
- Includes USB cable



Description	Pack quantity	Min. order quantity	Article Number	EAN Code
USB rechargeable BOLT headlamp 600 lumens	1	1	4933479902	4058546376963

BOLT™ 200

- Shell made of Lexan™ - ultra resistant to impacts.
- BOLT™ system – ensure compatibility among a large range of accessories with an easy and intuitive attachment system.
- Extremely comfortable and easy to adjust wheel ratchet adjustment system.
- Foam suspension provides consistent impact performance independent of impact location.
- Comfortable inner foam suspension paired with a crown liner for extra comfort.
- Breathable, washable and replaceable premium sweatband.
- Breathable, washable and replaceable premium crown liner.
- Vented version delivered with a mounted EN 12492 certified chinstrap (colour coded red).
- Unvented version delivered with a mounted EN 397 certified chinstrap (colour coded grey).
- Certified as per EN 397:2012 with optional requirement for Extreme temperatures – 40°C (vented and unvented version), Lateral Deformation (vented and unvented version) and Electrical insulation 440 V a.c. (unvented version).
- Vented version certified as per EN 12492:2012. Unvented version provides protection in conformity of EN12492: 2012 except clause 4.1.4.



Description	Pack quantity	Min. order quantity	Article Number	EAN Code
BOLT™200 White Vented - 1pc	1	1	4932478141	4058546340742
BOLT™200 Yellow Vented - 1pc	1	1	4932478918	4058546362003
BOLT™200 Red Vented - 1pc	1	1	4932478919	4058546362010
BOLT™200 Black Vented - 1pc	1	1	4932478920	4058546362027
BOLT™200 Blue Vented - 1pc	1	1	4932480651	4058546409364
BOLT™200 Green Vented - 1pc	1	1	4932480652	4058546409371
BOLT™200 Orange Vented - 1pc	1	1	4932480653	4058546409388
BOLT™200 Hi-Vis Vented - 1pc	1	1	4932480654	4058546409395

Description	Pack quantity	Min. order quantity	Article Number	EAN Code
BOLT™200 White Unvented - 1pc	1	1	4932479252	4058546370466
BOLT™200 Yellow Unvented - 1pc	1	1	4932479253	4058546370473
BOLT™200 Red Unvented - 1pc	1	1	4932479254	4058546370480
BOLT™200 Black Unvented - 1pc	1	1	4932479255	4058546370497
BOLT™200 Blue Unvented - 1pc	1	1	4932480655	4058546409401
BOLT™200 Green Unvented - 1pc	1	1	4932480656	4058546409418
BOLT™200 Orange Unvented - 1pc	1	1	4932480657	4058546409425
BOLT™200 Hi-Vis Yellow Unvented - 1pc	1	1	4932480658	4058546409432

BOLT™ Earmuff

- BOLT™ LP Earmuff provides an efficient job site noise attenuation SNR = 30 dB.
- BOLT™ HP Earmuffs provides an efficient job site noise attenuation SNR = 33 dB.
- BOLT™ system – ensure compatibility between the accessories with an easy and intuitive attachment system.
- Vertical adjustment and 360 degrees cup rotation for users' maximum comfort and attenuation.
- Extra comfortable foam in the earmuff's cushions for maximum comfort and protection.
- Compatible with Milwaukee BOLT™ 100 and BOLT™ 200 helmets in the rear and middle slot.
- European Certified hearing protectors: EN 352-3.



Description	Pack quantity	Min. order quantity	Article Number	EAN Code
BOLT™ HP Ear Muffs	1	1	4932478877	4058546361594
BOLT™ LP Ear Muffs	1	1	4932478878	4058546361600

BOLT™ Low-Profile Headlamp Mount

- Our BOLT™ Low-Profile Headlamp Mount allows headlamp compatibility with BOLT™ eye visors and select BOLT™ full face shields.
- The mount is reversible and secures into the Front or Rear BOLT™ Mount of your MILWAUKEE® head protection for added convenience.



Description	Pack quantity	Min. order quantity	Article Number	EAN Code
BOLT™ Low-Profile Headlamp Mount	1	1	4932493350	4058546482213

BOLT™ Face Shield

- Full face shield with panoramic field of vision.
- BOLT™ system – ensure compatibility among a large range of accessories with an easy and intuitive attachment system.
- Compatible with the BOLT™ Lamp: possibility to lift the face shield even with the lamp installed.
- Extremely easy and intuitive installation and removal.
- Lens made of polycarbonate.



Description	Pack quantity	Min. order quantity	Article Number	EAN Code
① BOLT™ Face Shield Compact Clear	1	1	4932479943	4058546377373
② BOLT™ Face Shield Compact Grey	1	1	4932479944	4058546377380
③ BOLT™ Mesh Face Shield Compact	1	1	4932479945	4058546377397
BOLT™ Face Shield Universal Clear	1	1	4932479938	4058546377328
BOLT™ Face Shield Universal Grey	1	1	4932479939	4058546377335
BOLT™ Mesh Face Shield Universal	1	1	4932479940	4058546377342
BOLT™ Face Shield Compact Clear Replacement (5 pc)	5	1	4932492327	4058546416942
BOLT™ Face Shield Compact Grey Replacement (5 pc)	5	1	4932492328	4058546416959
BOLT™ Face Shield Compact Carrier Replacement	1	1	4932492329	4058546416966
BOLT™ Face Shield Universal Clear Replacement	5	1	4932492324	4058546416911
BOLT™ Face Shield Universal Grey Replacement	5	1	4932492325	4058546416928
BOLT™ Face Shield Universal Carrier Replacement	1	1	4932492326	4058546416935

BOLT™ Contractor Face Shield

NEW

- Full face shield with panoramic field of vision.
- BOLT™ system – ensure compatibility among a large range of accessories with an easy and intuitive attachment system.
- Compatible with the BOLT™ Lamp: possibility to lift the face shield even with the lamp installed.
- Extremely easy and intuitive installation and removal.
- Compact lens colours: Clear, Grey. Replacement lenses and carrier available.



Description	Pack quantity	Min. order quantity	Article Number	EAN Code
① BOLT™ Contractor Face Shield KIT	1	1	4932498237	4058546521066
② BOLT™ Contractor Face Shield Replacement Lens CLEAR	10	10	4932498239	4058546521080
③ BOLT™ Contractor Face Shield FRAME	1	1	4932498238	4058546521073
④ BOLT™ W5 Contractor Face Shield replacement lens for gas welding	1	1	4932498989	4058546528584

BOLT™ Visor

- Visor with panoramic field of vision.
- BOLT™ system – ensure compatibility among a large range of accessories with an easy and intuitive attachment system.
- Compatible with the BOLT™ Lamp: possibility to lift the visor even with the lamp installed.
- Extremely easy and intuitive installation and removal.

Description	Pack quantity	Min. order quantity	Article Number	EAN Code
① BOLT™ Visor Compact Clear	1	1	4932479946	4058546377403
② BOLT™ Visor Compact Tinted	1	1	4932479947	4058546377410
BOLT™ Visor Universal Clear	1	1	4932479941	4058546377359
BOLT™ Visor Universal Tinted	1	1	4932479942	4058546377366
BOLT™ Visor Clear Lens Replacement (5 pc)	5	1	4932492330	4058546416973
BOLT™ Visor Tinted Lens Replacement (5pc)	5	1	4932492331	4058546416980
BOLT™ Visor Compact Carrier Replacement	1	1	4932492333	4058546417000
BOLT™ Visor Universal Carrier Replacement	1	1	4932492332	4058546416997



BOLT™ Badge Holder

- BOLT Badge holder allows everyday identification on the job site. Business card or ID size of 85 mm x 54 mm.
- Compatible with MILWAUKEE® BOLT™ 100 and BOLT™ 200 helmets in the front and back slot.
- Compatible with BOLT™ visors, face shield, earmuffs, sunshade.

Description	Pack quantity	Min. order quantity	Article Number	EAN Code
BOLT™ Badge Holder -1pc	1	1	4932493510	4058546483814



BOLT™ Cooling Accessories

- Long lasting cooling effect up to 4 hours, prolonging productive work hours and mitigating heat related illnesses.
- Soak or run product under water and wring out excess water to activate cooling effect.
- Quick, 30 second activation time.
- When cooling effect expires, simply re-apply water to reactivate the cooling effect.
- Soft, Comfortable Padding.
- Attaches to Suspension with Hook and Loop.
- Machine washable.

Description	Pack quantity	Min. order quantity	Article Number	EAN Code
① BOLT™ 200 Cooling Sweatband	1	1	4932498078	4058546512385
② BOLT™ 200 Cooling Crown Liner	1	1	4932498079	4058546512392
③ BOLT™ 100 Cooling Sweatband	1	1	4932498544	4058546524135

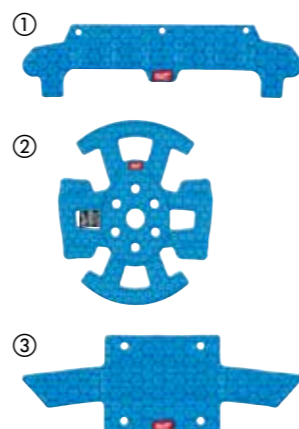

BOLT™ IMPACT ARMOR™ Crown Liner BOLT™200

- Advanced slip, trip & fall protection for MILWAUKEE® BOLT™200 helmet.
- BOLT™ IMPACT ARMOR™ liner reduces the risk of Traumatic Brain Injuries (TBI), as it protects from linear and rotational forces.
- Made of an advance energy absorbent super polymer utilizing RHEON™ Technology.

Description	Pack quantity	Min. order quantity	Article Number	EAN Code
BOLT™ IMPACT ARMOR™ Crown Liner BOLT™200	1	1	4932499173	4058546563370



BOLT™200 Spare Parts

- Padded breathable Crown liner and Sweatband as spare parts, that can be easily removed, machine washed (30°C), and changed.
- Two chin straps that can be easy exchange and replace to adapt to the job conditions. EN397 certified chin strap for on the ground work is colour coded in Black & Grey. EN12492 certified chin strap for work at height is colour coded in Black & Red.

Description	Pack quantity	Min. order quantity	Article Number	EAN Code
Replacement Sweatband BOLT™200 - Pack of 10	10	1	4932480659	4058546409449
Replacement Crown liner BOLT™200 - Pack of 10	10	1	4932480660	4058546409456
4pts EN397 chinstrap BOLT™ - 1pc	1	1	4932480661	4058546409463
4pts EN12492 chinstrap BOLT™200 - 1pc	1	1	4932480662	4058546409470
Sweatband Replacement BOLT 100	1	1	4932480667	4058546409524



Premium safety glasses with gasket



INCLUDES A SOFT CASE

	Lens colour	Packaging style	Pack quantity	Min. order quantity	Article Number	EAN Code
①	Clear	Blister packaging	1	1	4932471885	4058546297848
②	Polarised	Blister packaging	1	1	4932471886	4058546297855

Performance safety glasses



- Comfortable and flexible arms for extended comfort wear.
- Clear and tinted options offer eye protection whether working indoors or outdoors.
- European Certified: EN166 and EN170 / EN172.

	Lens colour	Packaging style	Pack quantity	Min. order quantity	Article Number	EAN Code
①	Clear	Blister packaging	1	1	4932471883	4058546297824
		Bulk Pack (48pcs)	48	1	4932479027	4058546363178
②	Tinted	Blister packaging	1	1	4932471884	4058546297831
		Bulk Pack (48pcs)	48	1	4932479028	4058546363185
③	Grey	Blister packaging	1	1	4932478908	4058546361907
		Bulk Pack (48pcs)	48	1	4932479029	4058546363192
④	Yellow	Blister packaging	1	1	4932478928	4058546362102
⑤	Photochromic	Gift box	1	1	4932498367	4058546522360
⑥	Mirrored Silver	Gift box	1	1	4932498366	4058546522353

Enhanced safety glasses



- Light weight for extended comfort while wearing.
- Comfortable and flexible arms for extended comfort wear.
- Clear, yellow and tinted/mirrored options offer eye protection whether working indoors or outdoors.
- European Certified: EN166 and EN170 / EN172.

	Lens colour	Packaging style	Pack quantity	Min. order quantity	Article Number	EAN Code
①	Clear	Polybag	1	1	4932478763	4058546360450
		Bulk Pack (144pcs)	144	1	4932479024	4058546363147
②	Tinted	Polybag	1	1	4932478764	4058546360467
		Bulk Pack (144pcs)	144	1	4932479025	4058546363154
③	Grey	Polybag	1	1	4932478907	4058546361891
		Bulk Pack (144pcs)	144	1	4932479026	4058546363161
④	Yellow	Polybag	1	1	4932478927	4058546362096
⑤	Mirrored Red	Gift box	1	1	4932498548	4058546524173
⑥	Mirrored Silver	Gift box	1	1	4932498365	4058546522346

Safety glasses



- Light weight for extended comfort while wearing.
- Fully adjustable and removable nose bridge to fit comfortably all face shapes.
- Comfortable and flexible arms for extended comfort wear.
- Clear and tinted options offer eye protection whether working indoors or outdoors.
- European Certified: EN166 and EN170 / EN172.

	Lens colour	Packaging style	Pack quantity	Min. order quantity	Article Number	EAN Code
①	Clear	Polybag	1	12	4932471881	4058546297800
②	Tinted	Polybag	1	12	4932471882	4058546297817

Magnified safety glasses



- Magnified lenses - Offer users an optical correction to improve their eyesight for close application.
- 4 magnifying intensity: +1 / +1.5 / +2 / +2.5
- Light weight for extended comfort while wearing.
- Durable anti-scratch lenses.
- Comfortable and flexible arms for extended comfort wear.
- European Certified: EN166.

Description	Pack quantity	Min. order quantity	Article number	EAN Code
Clear Safety Glasses (+1)	1	1	4932478909	4058546361914
Clear Safety Glasses (+1.5)	1	1	4932478910	4058546361921
Clear Safety Glasses (+2)	1	1	4932478911	4058546361938
Clear Safety Glasses (+2.5)	1	1	4932478912	4058546361945

Hard Case For Safety Glasses

- Hard case to protect the safety glasses of job site conditions.
- Soft terry liner inside to avoid scratches on the lenses.
- Include hook for easy portability on the job site.
- Compatible with Milwaukee safety glasses: Enhanced Safety Glasses, Magnified Safety Glasses, Performance Safety Glasses, Premium Safety Glasses with Gasket.



Description	Pack quantity	Min. order quantity	Article Number	EAN Code
Hard Case Safety Glasses	1	1	4932492083	4058546414504

High-Profile Goggles Non-Vented

- Durable anti-scratch lenses
- Long lasting anti-fog lenses
- Enhanced impact protection
- Protection against splashes and liquids
- Non-vented, for work with gases and vapors
- European Certified: EN166 and EN170 / EN172



Description	Pack quantity	Min. order quantity	Article Number	EAN Code
① High-Profile Goggles Non-Vented Grey	1	1	4932493438	4058546483098
② High-Profile Goggles Non-Vented Clear	1	1	4932493437	4058546483081

High-Profile Goggles Vented

- Durable anti-scratch lenses
- Long lasting anti-fog lenses
- Enhanced impact protection
- Protection against splashes and liquids
- Indirect ventilation
- European Certified: EN166 and EN170 / EN172



Description	Pack quantity	Min. order quantity	Article Number	EAN Code
① High-Profile Goggles Vented Clear	1	1	4932493435	4058546483067
② High-Profile Goggles Vented Tinted	1	1	4932493436	4058546483074

Low-Profile Goggles Vented

- Durable anti-scratch lenses
- Long lasting anti-fog lenses
- Enhanced impact protection
- Protection against splashes and liquids
- Indirect ventilation
- Compact for narrow space
- European Certified: EN166 and EN170 / EN172



Description	Pack quantity	Min. order quantity	Article Number	EAN Code
① Low-Profile Goggles Vented Clear	1	1	4932493433	4058546483043
② Low-Profile Goggles Vented Tinted	1	1	4932493434	4058546483050

Over The Glasses

- Durable anti-scratch lenses
- Long lasting anti-fog lenses
- Comfortable and flexible arms for extended comfort wear
- Fits for wearing over the most popular prescription glasses frames
- Wraparound frame
- European Certified: EN166, EN170 and EN172



Description	Lens colour	Pack quantity	Min. order quantity	Article Number	EAN Code
① Over The Glasses Clear	Clear	1	1	4932493439	4058546483104
② Over The Glasses Tinted	Tinted	1	1	4932493440	4058546483111

USB RECHARGEABLE HEARING ASSIST EARPLUGS W/BLUETOOTH®

- Jobsite awareness provides controllable situational awareness, while reducing the intensity of loud external noises
- Digital Bluetooth® 5.1 connects devices and allows listening to music/ podcast/ audio books/ media and accept/ talk on/ decline phone calls
- European Certified hearing protectors: EN 352-2:2020 (SNR silicone ear plugs = 26 dB; SNR Foam ear plugs = 32 dB); EN 352-7:2020; EN 352-9:2020; and EN 352-10:2020
- Designed for on-the-job use, passive hearing protection is provided by silicone and foam ear tips
- Interchangeable foam ear tips and silicone ear tips as well as wings included
- Small enough to not interfere with any PPE or hoods & hats
- Light enough to minimise in-ear fatigue and to sit flush in-ear
- Up to 10 hours of run time on a single charge
- The REDLITHIUM™ USB case battery provides up to 70 hours of run time using multiple in-case charges
- A state of charge light feature allows end user to be informed of low battery status
- Built to endure: IP67-rated earplugs and an IP64-rated charging case protect against dust, water, and toughest jobsite conditions.



Description	Pack quantity	Min. order quantity	Article Number	EAN Code
USB RECHARGEABLE HEARING ASSIST EARPLUGS W/BLUETOOTH	1	1	4933478750	4058546360320

Memory foam ear tip replacement

Description	Pack quantity	Min. order quantity	Article Number	EAN Code
5 pairs memory foam ear tip L replacement	1	1	4932493359	4058546482305
5 pairs memory foam ear tip M replacement	1	1	4932493360	4058546482312
5 pairs memory foam ear tip S replacement	1	1	4932493361	4058546482329



Ear Tip Double Layer Replacement

Description	Pack quantity	Min. order quantity	Article Number	EAN Code
Ear tip silicone S replacement	1	1	4932493364	4058546482350
Ear tip silicone M replacement	1	1	4932493363	4058546482343
Ear tip silicone L replacement	1	1	4932493362	4058546482336



Foam ear plugs

- Efficient jobsite noise attenuation of SNR = 38 dB.
- Comfortable foam - to wear all day.
- Quick expansion to ensure a rapid and secure seal.
- Individually packed pairs (200 pairs), resealable packaging (10 pairs) for hygienic and easy distribution.
- European Certified hearing protectors: EN352-2 (SNR = 38 dB; H = 37; M = 36 dB; L = 32 dB).



Description	Pack quantity	Min. order quantity	Article Number	EAN Code
Foam Ear Plugs - 10 pairs	1	1	4932480464	4058546407490
Foam Ear Plugs - 200 pairs	200	1	4932480465	4058546407506

Banded ear plugs

- 3-point wear: above head, below chin and behind the neck.
- Pivoting arms to adjust and pivot the band to a secure and comfortable position while being worn.
- Earplugs can be worn continuously even if the wearing position is changed – permanent protection.
- Interchangeable foam earplugs and tpr flanged earplugs included.
- Durable and comfortable band for a long lifetime.
- European Certified hearing protectors: EN 352-2 (SNR TPR ear plugs = 32 dB; SNR Foam ear plugs = 33 dB).



Description	Pack quantity	Min. order quantity	Article Number	EAN Code
① Banded Ear Plugs	1	1	4932478135	4058546340681
② Foam Replacement - 5 pairs	5	1	4932478550	4058546347437
③ TPR Replacement - 5 pairs	5	1	4932478549	4058546347420

Reusable corded ear plugs

- Efficient jobsite noise attenuation of SNR = 31 dB.
- Corded solution for easy access - can be worn around the neck.
- Comfortable silicone - all day comfort.
- Quick-fit design to quickly insert and remove while achieving a secure seal.
- Storage box included - keep the ear plugs clean.
- European Certified hearing protectors: EN352-2 (SNR = 31 dB).



Description	Pack quantity	Min. order quantity	Article Number	EAN Code
Reusable corded ear plugs	3	1	4932471904	4058546298036

PACKOUT™ First Aid Kit DIN 13157

- Quickly identifiable during an emergency due to red coloured PACKOUT™ Compact Organiser.
- Part of the PACKOUT™ modular storage system.
- Constructed with impact resistant polymers for jobsite durability.
- IP65 rated weather seal to keep out rain and jobsite debris.
- The interior features 5 removable & mountable bins.
- No-travel bins seals to prevent the bins contents from migrating between bins during transport.
- DIN 13157:2021-11 compliant first aid kit.



DESIGNED FOR USE IN
PACKOUT™



Description	Pack quantity	Min. order quantity	Article Number	EAN Code
PACKOUT™ First Aid Kit DIN 13157	1	1	4932478879	4058546361617
PACKOUT™ First Aid Kit XL DIN 13157	1	1	4932492962	4058546478339

Premium high-visibility vest

- 15 pockets - increased carrying capacity.
- 1 clear ID badge holder - easy identification on the jobsite.
- 1 back pocket - ideal to carry tablet or notebook.
- Quick internal size adjustment - size up or size down for better fit.
- Padded collar - added comfort for extended wear.
- Harness tethering hole - ideal to fit over harness to add more safety on the jobsite.
- European Certified as Class 2 High Visibility Clothing according to EN ISO 20471: 2013/A1:2016.



Description	Colour	Pack quantity	Min. order quantity	Article Number	EAN Code
Premium high-visibility vest yellow - S/M	Yellow	1	1	4932471895	4058546297947
Premium high-visibility vest yellow - L/XL	Yellow	1	1	4932471896	4058546297954
Premium high-visibility vest yellow - 2XL/3XL	Yellow	1	1	4932471897	4058546297961
Premium high-visibility vest orange - S/M	Orange	1	1	4932471898	4058546297978
Premium high-visibility vest orange - L/XL	Orange	1	1	4932471899	4058546297985
Premium high-visibility vest orange - 2XL/3XL	Orange	1	1	4932471900	4058546297992

High-visibility vest

- 10 pockets - increased carrying capacity.
- 1 clear ID badge holder - easy identification on the jobsite.
- Quick internal size adjustment - size up or size down for better fit.
- Harness tethering hole - ideal to fit over harness to add more safety on the jobsite.
- European Certified as Class 2 High Visibility Clothing according to EN ISO 20471: 2013/A1:2016.



Description	Colour	Pack quantity	Min. order quantity	Article Number	EAN Code
High-visibility vest yellow - S/M	Yellow	1	1	4932471889	4058546297886
High-visibility vest yellow - L/XL	Yellow	1	1	4932471890	4058546297893
High-visibility vest yellow - 2XL/3XL	Yellow	1	1	4932471891	4058546297909
High-visibility vest orange - S/M	Orange	1	1	4932471892	4058546297916
High-visibility vest orange - L/XL	Orange	1	1	4932471893	4058546297923
High-visibility vest orange - 2XL/3XL	Orange	1	1	4932471894	4058546297930

Contractor High-Visibility Vest

- 1 clear ID badge holder for easy identification on the jobsite.
- Mic tab for convenient radio access.
- 1 Internal pocket for storage of papers, pens, etc.
- Hanger loop to easily hang up your vest after use.
- Durable zipper for open/closure.
- Machine washable.
- European Certified as Class 2 High Visibility Clothing according to EN ISO 20471: 2013/A1:2016.



Description	Colour	Pack quantity	Min. order quantity	Article Number	EAN Code
Contractor High-Visibility Vest Yellow S/M	Hi-vis yellow	1	1	4932493994	4058546511548
Contractor High-Visibility Vest Yellow L/XL	Hi-vis yellow	1	1	4932493995	4058546511555
Contractor High-Visibility Vest Yellow 2XL/3XL	Hi-vis yellow	1	1	4932493996	4058546511562
Contractor High-Visibility Vest Yellow 4XL/5XL	Hi-vis yellow	1	1	4932493997	4058546511579
Contractor High-Visibility Vest Orange S/M	Hi-vis orange	1	1	4932493998	4058546511586
Contractor High-Visibility Vest Orange L/XL	Hi-vis orange	1	1	4932493999	4058546511593
Contractor High-Visibility Vest Orange 2XL/3XL	Hi-vis orange	1	1	4932498000	4058546511609
Contractor High-Visibility Vest Orange 4XL/5XL	Hi-vis orange	1	1	4932498001	4058546511616

MILWAUKEE® GLOVES GUIDE

Rating	4 3 4 3 C X
Abrasion	1-4
Cut (Coup Test)	1-5
Tear	1-4
Puncture	1-4
Cut (TDM-100 Test)	A-F
Impact Protection	PFX

X= Not tested P= Pass X= Fail

FEATURES KEY

COMFORT DEXTERITY SMARTSWIPE™ CUT RESISTANCE HIGH VISIBILITY BREATHABILITY REINFORCEMENT

BREATHABILITY FULL ARM COVERAGE CUT RESISTANCE LEVEL

EN388:2016



	CUT LEVEL A	CUT LEVEL B	CUT LEVEL C	CUT LEVEL D	CUT LEVEL E	CUT LEVEL F	CUT LEVEL C	CUT LEVEL E	HI-VIS CUT LEVEL A	HI-VIS CUT LEVEL B	HI-VIS CUT LEVEL C	HI-VIS CUT LEVEL D	HI-VIS CUT LEVEL E	HI-DEX CUT LEVEL B	HI-DEX CUT LEVEL C	HI-DEX CUT LEVEL D
FEATURES																
EN 388 RATING	4121A	4242B	4343C	4X43D	4X44E	4X43F	2342C	3X42E	3121A	3242B	4X42C	4X43D	4X43E	4242B	4342C	4X42D
COLOUR CODE																
GAUGE	13	15	15	13	13	18	15	13	15	15	15	13	13	18	18	18
COATING	Nitrile - Sandy	Nitrile - Sandy	Nitrile - Microfoam	Nitrile - Sandy	Nitrile - Sandy	Nitrile - Sandy	-	-	Polyurethane (PU)	Polyurethane (PU)	Polyurethane (PU)	Polyurethane (PU)	Polyurethane (PU)	Polyurethane (PU)	Polyurethane (PU)	Polyurethane (PU)
ENVIRONMENT	Dry, damp, oily (WASHABLE)	Dry, damp, oily (WASHABLE)	Dry, damp, oily (WASHABLE)	Dry, damp, oily (WASHABLE)	Dry, damp, oily (WASHABLE)	Dry, damp, oily (WASHABLE)	-	-	Dry (WASHABLE)	Dry (WASHABLE)	Dry (WASHABLE)	Dry (WASHABLE)	Dry (WASHABLE)	Dry (WASHABLE)	Dry (WASHABLE)	Dry (WASHABLE)
APPLICATIONS																
AUTOMOTIVE/ TRANSPORTATION	✓	✓	✓	-	-	-	✓	-	✓	✓	✓	✓	✓	✓	✓	✓
CARPENTRY	✓	✓	-	-	-	-	✓	-	✓	✓	-	-	-	✓	✓	-
CIVIL ENGINEERING	✓	✓	✓	✓	✓	-	✓	✓	✓	✓	✓	✓	✓	✓	✓	✓
CONSTRUCTION	✓	✓	✓	✓	✓	-	✓	✓	✓	✓	✓	✓	✓	✓	✓	✓
DEMOLITION	-	-	✓	✓	✓	-	✓	✓	-	-	-	-	-	-	-	-
DRYWALL, CEILING AND PARTIONING	-	✓	✓	✓	-	-	✓	✓	-	✓	✓	✓	-	✓	✓	✓
LANDSCAPING AND HORTICULTURAL	✓	✓	-	-	-	-	✓	-	-	-	-	-	-	-	-	-
MAINTENANCE, REPAIR AND OPERATIONS	-	-	-	-	-	-	-	-	-	-	-	-	-	-	-	-
MANUFACTURING	✓	✓	✓	✓	✓	✓	✓	✓	✓	✓	✓	✓	✓	✓	✓	✓
ASSEMBLE	✓	✓	-	-	-	-	✓	-	✓	✓	-	-	-	✓	✓	✓
METALWORKING AND ENGINEERING	-	-	✓	✓	✓	✓	✓	✓	-	-	✓	✓	✓	-	✓	✓
HVAC	-	-	✓	✓	✓	✓	-	✓	-	-	✓	✓	✓	-	✓	✓
PLUMBING	✓	✓	✓	-	-	-	-	-	-	-	-	-	-	-	-	-
UTILITIES	✓	✓	✓	-	-	-	✓	-	✓	✓	✓	-	-	✓	✓	✓
OIL & GAS	✓	✓	✓	✓	✓	✓	-	-	-	-	-	-	-	-	-	-

PERSONAL PROTECTIVE EQUIPMENT

MILWAUKEE® GLOVES GUIDE

Rating	4 3 4 3 C X
Abrasion	1-4
Cut (Coup Test)	1-5
Tear	1-4
Puncture	1-4
Cut (TDM-100 Test)	A-F
Impact Protection	PFX

X= Not tested P= Pass X= Fail

FEATURES KEY

WINTER CUT RESISTANT GLOVES

WORK GLOVES

GLOVE TYPES



	CUT LEVEL A	CUT LEVEL B	CUT LEVEL C	CUT LEVEL D	CUT LEVEL E	DEMOX	PERFORMANCE WORK GLOVES	FLEX WORK GLOVES	PAD PRO WORK GLOVES	HYBRID LEATHER	LEATHER	CHAIN SAW
FEATURES												
EN 388 RATING	EN388: 1141A EN511: 01X	EN388: 2242B EN511: X1X	EN388: 2442C EN511: 02X	EN388: 3X43D EN511: X1X	EN 388: 3X43E EN 511: X1X	EN388: 2121A	EN388: 2121A	EN388: 2121A	EN388: 2121A, EN 407: X1XXXX	2122X	2122X	N ISO 11393: class 1, Design A, Typ 1 EN388: 2122A
COLOUR CODE						-	-	-	-	-	-	-
GAUGE	15,10	15,10	15,7	15,10	13,10	-	-	-	-	-	-	-
COATING	Latex	Latex	Latex	Latex	Latex	-	-	-	-	-	-	-
ENVIRONMENT	Cold, damp, dry (WASHABLE)	Cold, damp, dry (WASHABLE)	Cold, damp, dry (WASHABLE)	Cold, damp, dry (WASHABLE)	Cold, damp, dry (WASHABLE)	Dry (WASHABLE)	Dry (WASHABLE)	Dry (WASHABLE)	Dry (WASHABLE)	-	-	Dry, damp
APPLICATIONS												
AUTOMOTIVE/TRANSPORTATION	✓	-	-	-	-	-	-	-	-	-	-	-
CARPENTRY	✓	✓	-	-	-	✓	✓	✓	-	✓	✓	-
CIVIL ENGINEERING	-	-	-	-	-	✓	✓	✓	✓	-	-	-
CONSTRUCTION	✓	✓	✓	✓	✓	✓	✓	-	✓	✓	✓	-
DEMOLITION	-	-	✓	✓	✓	✓	-	-	✓	-	-	-
DRYWALL, CEILING AND PARTITIONING	-	✓	✓	✓	-	✓	-	-	-	-	-	-
LANDSCAPING AND HORTICULTURAL	✓	✓	-	-	-	-	-	-	-	✓	✓	✓
MAINTENANCE, REPAIR AND OPERATIONS	-	-	-	-	-	-	✓	-	✓	-	-	-
MANUFACTURING	✓	✓	-	-	-	-	-	✓	✓	-	-	-
ASSEMBLE	-	-	-	-	-	-	✓	✓	-	-	-	-
METALWORKING AND ENGINEERING	-	-	-	✓	✓	-	-	-	-	-	-	-
HVAC	-	-	✓	✓	✓	-	-	-	-	-	-	-
PLUMBING	✓	✓	-	-	-	-	-	-	-	-	-	-
UTILITIES	✓	✓	-	-	-	✓	-	-	-	✓	✓	-
OIL & GAS	✓	✓	✓	✓	✓	-	-	-	-	-	-	-

PERSONAL PROTECTIVE EQUIPMENT

MILWAUKEE® GLOVES GUIDE

Rating	4 3 4 3 C X
Abrasion	1-4
Cut (Coup Test)	1-5
Tear	1-4
Puncture	1-4
Cut (TDM-100 Test)	A-F
Impact Protection	PFX

X= Not tested P= Pass X= Fail

FEATURES KEY



	CHEMICAL	NITRILE DISPOSABLE GLOVES	FULLY DIPPED	GENERAL GLOVES	WINTER DEMOLITION	IMPACT PRO C	IMPACT PRO E	PAD PRO CUT D	IMPACT DEMO X
FEATURES									
EN RATING	EN ISO 374- 1:2016 Type A/ JKLM-NO, EN388: 4121A, EN 407: X1XXX, Food contact approved	EN ISO 374- 1:2016 Type B / KPT	EN388: 4221A, EN 407: X1XXX	EN388: 3121A	EN 388: 2122A EN 511: 14X	EN388: 4343CP, EN 407: X1XXX	EN388:2016 (4343EP), EN 407 (X1XXX)	EN388: 4X42D, EN 407: X1XXXX	2121AP
COLOUR CODE	-	-			-				-
GAUGE			15	13	-	15		18	-
COATING			Nitrile	Polyurethane (PU)	-	Nitrile - Sandy	Nitrile - Sandy		-
ENVIRONMENT	Damp, wet, chemicals	Damp, wet, oily chemicals	Damp, wet, oily (WASHABLE)	Dry	Cold, damp, dry (WASHABLE)	Dry, damp, oily (WASHABLE)	Dry, damp, oily (WASHABLE)	Dry, damp, oily (WASHABLE)	Dry (WASHABLE)
APPLICATIONS									
AUTOMOTIVE/ TRANSPORTATION	✓	✓	✓	-	-	-	-	-	-
CARPENTRY	-	-	-	✓	✓	-	-	-	-
CIVIL ENGINEERING	✓	-	✓	✓	-	✓	✓	✓	-
CONSTRUCTION	-	-	✓	✓	✓	✓	✓	✓	✓
DEMOLITION	-	-	-	-	✓	✓	✓	✓	✓
DRYWALL, CEILING AND PARTIONING	-	-	-	-	-	✓	✓	-	-
LANDSCAPING AND HORTICULTURAL	✓	✓	✓	-	-	-	-	-	-
MAINTENANCE, REPAIR AND OPERATIONS	-	✓	✓	✓	-	-	-	✓	-
MANUFACTURING	-	✓	✓	✓	-	-	-	✓	-
ASSEMBLE	-	-	-	✓	-	-	-	-	-
METALWORKING AND ENGINEERING	-	✓	-	-	-	-	-	✓	-
HVAC	-	-	✓	-	✓	-	-	-	-
PLUMBING	✓	✓	✓	-	-	-	-	-	-
UTILITIES	✓	-	✓	-	✓	-	-	-	-
OIL & GAS	✓	-	✓	-	✓	-	-	-	✓

PERSONAL PROTECTIVE EQUIPMENT

Cut resistant dipped gloves

Description	Colour code	Size	Pack quantity	Min. order quantity	Article Number	EAN Code
① Cut A Gloves	White	7 / S	1	1	4932479712	4058546375065
		7 / S	12	1	4932479713	4058546375072
		8 / M	1	1	4932471416	4058546290443
		8 / M	12	1	4932471614	4058546295134
		9 / L	1	1	4932471417	4058546290450
		9 / L	12	1	4932471615	4058546295141
		10 / XL	1	1	4932471418	4058546290467
		10 / XL	12	1	4932471616	4058546295158
		11 / XXL	1	1	4932471419	4058546290474
		11 / XXL	12	1	4932471617	4058546295165
		② Cut B Gloves	Blue	7 / S	1	1
8 / M	1			1	4932479907	4058546377014
9 / L	1			1	4932479908	4058546377021
10 / XL	1			1	4932479909	4058546377038
11 / XXL	1			1	4932479910	4058546377045
③ Cut C Gloves	Black	7 / S	1	1	4932479715	4058546375096
		7 / S	12	1	4932479716	4058546375102
		8 / M	1	1	4932471420	4058546290481
		8 / M	12	1	4932471618	4058546295172
		9 / L	1	1	4932471421	4058546290498
		9 / L	12	1	4932471619	4058546295189
		10 / XL	1	1	4932471422	4058546290504
		10 / XL	12	1	4932471620	4058546295196
④ Cut D Gloves	Grey	7 / S	1	1	4932479911	4058546377052
		8 / M	1	1	4932479912	4058546377069
		9 / L	1	1	4932479913	4058546377076
		10 / XL	1	1	4932479914	4058546377083
		11 / XXL	1	1	4932479915	4058546377090
⑤ Cut E Gloves	Red	7 / S	1	1	4932479718	4058546375126
		7 / S	12	1	4932479719	4058546375133
		8 / M	1	1	4932471424	4058546290528
		8 / M	12	1	4932471622	4058546295219
		9 / L	1	1	4932471425	4058546290535
		9 / L	12	1	4932471623	4058546295226
		10 / XL	1	1	4932471426	4058546290542
		10 / XL	12	1	4932471624	4058546295233
		11 / XXL	1	1	4932471427	4058546290559
		11 / XXL	12	1	4932471625	4058546295240



Description	Colour code	Size	Pack quantity	Min. order quantity	Article Number	EAN Code
⑥ High Cut F Gloves	Purple	7 / S	1	1	4932492040	4058546413521
		7 / S	12	1	4932492045	4058546413576
		8 / M	1	1	4932492041	4058546413538
		8 / M	12	1	4932492046	4058546413583
		9 / L	1	1	4932492042	4058546413545
		9 / L	12	1	4932492047	4058546413590
		10 / XL	1	1	4932492043	4058546413552
		10 / XL	12	1	4932492048	4058546413606
		11 / XXL	1	1	4932492044	4058546413569
		11 / XXL	12	1	4932492049	4058546413613
		⑦ General Gloves	White	7 / S	12	1
8 / M	12			1	4932493239	4058546481100
9 / L	12			1	4932493240	4058546481117
10 / XL	12			1	4932493241	4058546481124
11 / XXL	12			1	4932493242	4058546481131



Cut C Sleeves

- High stretch nylon material with 4-way stretch points to fit users' arms.
- Tapered design, wider on the bicep and tight on the wrist, to fit the natural arm form.
- Elastic band with non-slip dots on the bicep and stretch wrist cuff to keep the sleeves in place and prevent them from sagging.
- Breathable and lightweight material provides good dexterity and all-day comfort.
- Elastic thumb loop avoids pressure points when using gloves.
- Sun UV rays protection with UPF 50+ according to BS EN 13758-1:2002 +A1:2006 for the covered part of the arms.
- European Certified for cut protection: EN ISO 21420, EN388:2016 (2342C), UKCA.



Description	Niveau anti coupure	Colour code	Pack quantity	Min. order quantity	Article Number	EAN Code
Cut C Sleeves - 40cm	C	Black	1	1	4932478584	4058546347772
Cut C Sleeves - 45cm	C	Black	1	1	4932478585	4058546347789

Cut E Sleeves

- High stretch nylon material with 4-way stretch points to fit users' arms.
- Tapered design, wider on the bicep and tight on the wrist, to fit the natural arm form.
- Elastic band with non-slip dots on the bicep and stretch wrist cuff to keep the sleeves in place and prevent them from sagging.
- Breathable and lightweight material provides good dexterity and all-day comfort.
- Elastic thumb loop avoids pressure points when using gloves.
- Sun UV rays protection with UPF 50+ according to BS EN 13758-1:2002 +A1:2006 for the covered part of the arms.
- European Certified for cut protection: EN ISO 21420, EN388:2016 (3X42E), UKCA.



Description	Niveau anti coupure	Colour code	Pack quantity	Min. order quantity	Article Number	EAN Code
Cut E Sleeves - 40cm	E	Red	1	1	4932479936	4058546377304
Cut E Sleeves - 45cm	E	Red	1	1	4932479937	4058546377311

Winter cut resistant gloves

Description	Colour code	Size	Pack quantity	Min. order quantity	Article Number	EAN Code
① Winter Cut A Gloves	White	7 / S	1	1	4932479704	4058546374983
		7 / S	12	1	4932479705	4058546374990
		7 / S	72	1	4932479706	4058546375003
		8 / M	1	1	4932471343	4058546289713
		8 / M	12	1	4932471606	4058546295059
		8 / M	72	1	4932479000	4058546362904
		9 / L	1	1	4932471344	4058546289720
		9 / L	12	1	4932471607	4058546295066
		9 / L	72	1	4932479001	4058546362911
		10 / XL	1	1	4932471345	4058546289737
		10 / XL	12	1	4932471608	4058546295073
		10 / XL	72	1	4932479002	4058546362928
		11 / XXL	1	1	4932471346	4058546289744
		11 / XXL	12	1	4932471609	4058546295080
11 / XXL	72	1	4932479003	4058546362935		
② Winter Cut B Gloves	Blue	7 / S	1	1	4932480601	4058546408862
		7 / S	12	1	4932480606	4058546408916
		8 / M	1	1	4932480602	4058546408879
		8 / M	12	1	4932480607	4058546408923
		9 / L	1	1	4932480603	4058546408886
		9 / L	12	1	4932480608	4058546408930
		10 / XL	1	1	4932480604	4058546408893
		10 / XL	12	1	4932480609	4058546408947
		11 / XXL	1	1	4932480605	4058546408909
		11 / XXL	12	1	4932480610	4058546408954
		③ Winter Cut C Gloves	Black	7 / S	1	1
7 / S	12			1	4932479708	4058546375027
7 / S	72			1	4932479709	4058546375034
8 / M	1			1	4932471347	4058546289751
8 / M	12			1	4932471610	4058546295097
8 / M	72			1	4932479004	4058546362942
9 / L	1			1	4932471348	4058546289768
9 / L	12			1	4932471611	4058546295103
9 / L	72			1	4932479005	4058546362959
10 / XL	1			1	4932471349	4058546289775
10 / XL	12			1	4932471612	4058546295110
10 / XL	72			1	4932479006	4058546362966
11 / XXL	1			1	4932471350	4058546289782
11 / XXL	12			1	4932471613	4058546295127
11 / XXL	72	1	4932479007	4058546362973		
④ Winter Cut D Gloves	Grey	7 / S	1	1	4932480611	4058546408961
		7 / S	12	1	4932480616	4058546409012
		8 / M	1	1	4932480612	4058546408978
		8 / M	12	1	4932480617	4058546409029
		9 / L	1	1	4932480613	4058546408985
		9 / L	12	1	4932480618	4058546409036
		10 / XL	1	1	4932480614	4058546408992
		10 / XL	12	1	4932480619	4058546409043
		11 / XXL	1	1	4932480615	4058546409005
		11 / XXL	12	1	4932480620	4058546409050
		⑤ Winter cut E gloves	Red	7 / S	1	1
7 / S	12			1	4932479711	4058546375058
8 / M	1			1	4932479558	4058546373528
8 / M	12			1	4932479562	4058546373566
9 / L	1			1	4932479559	4058546373535
9 / L	12			1	4932479563	4058546373573
10 / XL	1			1	4932479560	4058546373542
10 / XL	12			1	4932479564	4058546373580
11 / XXL	1			1	4932479561	4058546373559
11 / XXL	12			1	4932479565	4058546373597



High visibility cut resistant gloves

Description	Colour code	Size	Pack quantity	Min. order quantity	Article Number	EAN Code
① Hi-vis Cut A Gloves	White	7 / S	1	1	4932479916	4058546377106
		7 / S	12	1	4932492913	4058546477844
		8 / M	1	1	4932479917	4058546377113
		8 / M	12	1	4932492914	4058546477851
		9 / L	1	1	4932479918	4058546377120
		9 / L	12	1	4932492915	4058546477868
		10 / XL	1	1	4932479919	4058546377137
		10 / XL	12	1	4932492916	4058546477875
		11 / XXL	1	1	4932479920	4058546377144
		11 / XXL	12	1	4932492917	4058546477882
		② Hi-Vis Cut B Gloves	Blue	7 / S	1	1
8 / M	1			1	4932479922	4058546377168
9 / L	1			1	4932479923	4058546377175
10 / XL	1			1	4932479924	4058546377182
11 / XXL	1			1	4932479925	4058546377199
7 / S	1			1	4932479721	4058546375157
7 / S	12			1	4932492918	4058546477899
③ Hi-vis Cut C Gloves	Black	8 / M	1	1	4932478131	4058546340643
		8 / M	12	1	4932492919	4058546477905
		9 / L	1	1	4932478132	4058546340650
		9 / L	12	1	4932492920	4058546477912
		10 / XL	1	1	4932478133	4058546340667
		10 / XL	12	1	4932492921	4058546477929
		11 / XXL	1	1	4932478134	4058546340674
		11 / XXL	12	1	4932492922	4058546477936
		7 / S	1	1	4932479926	4058546377205
		8 / M	1	1	4932479927	4058546377212
		④ Hi-Vis Cut D Gloves	Grey	9 / L	1	1
10 / XL	1			1	4932479929	4058546377236
11 / XXL	1			1	4932479930	4058546377243
7 / S	1			1	4932479931	4058546377250
⑤ Hi-Vis Cut E Gloves	Red	8 / M	1	1	4932479932	4058546377267
		9 / L	1	1	4932479933	4058546377274
		10 / XL	1	1	4932479934	4058546377281
		11 / XXL	1	1	4932479935	4058546377298



Hi-Dex Cut Gloves Summary Table

Description	Colour code	Size	Pack quantity	Min. order quantity	Article Number	EAN Code
Hi-Dex Cut B Gloves	Blue	7 / S	1	1	4932480491	4058546407766
		7 / S	12	1	4932480506	4058546407919
		8 / M	1	1	4932480492	4058546407773
		8 / M	12	1	4932480507	4058546407926
		9 / L	1	1	4932480493	4058546407780
		9 / L	12	1	4932480508	4058546407933
		10 / XL	1	1	4932480494	4058546407797
		10 / XL	12	1	4932480509	4058546407940
		11 / XXL	1	1	4932480495	4058546407803
		11 / XXL	12	1	4932480510	4058546407957
Hi-Dex Cut C Gloves	Black	7 / S	1	1	4932480496	4058546407810
		7 / S	12	1	4932480511	4058546407964
		8 / M	1	1	4932480497	4058546407827
		8 / M	12	1	4932480512	4058546407971
		9 / L	1	1	4932480498	4058546407834
		9 / L	12	1	4932480513	4058546407988
		10 / XL	1	1	4932480499	4058546407841
		10 / XL	12	1	4932480514	4058546407995
		11 / XXL	1	1	4932480500	4058546407858
		11 / XXL	12	1	4932480515	4058546408008
Hi-Dex Cut D Gloves	Grey	7 / S	1	1	4932480501	4058546407865
		7 / S	12	1	4932480516	4058546408015
		8 / M	1	1	4932480502	4058546407872
		8 / M	12	1	4932480517	4058546408022
		9 / L	1	1	4932480503	4058546407889
		9 / L	12	1	4932480518	4058546408039
		10 / XL	1	1	4932480504	4058546407896
		10 / XL	12	1	4932480519	4058546408046
		11 / XXL	1	1	4932480505	4058546407902
		11 / XXL	12	1	4932480520	4058546408053



Chemical Gloves Grip

- Chemical protection, mechanical protection, and heat protection gloves to enhanced user safety.
- Glove length of 350mm with gauntlet cuff style to protect the forearm.
- Triple nitrile coating for increase durability.
- Excellent grip performance on wet and oily surfaces due to the sandy nitrile finish on the palm.
- 18 gauges soft inner liner and latex-free composition to ensure comfort over long periods of used.
- European Certified for chemical, mechanical and heat protection: EN ISO 374- 1:2016 Type A/ JKLMNO, EN ISO 374 -2, EN ISO 374-5 (VIRUS), EN ISO 21420, EN388 (4121A), EN 407 (X1XXX), Food contact approved, UKCA, EAC, UKRAINE



Description	Pack quantity	Min. order quantity	Article Number	EAN Code
Chemical Gloves Grip - 7/S - 1pc	1	1	4932493228	4058546480998
Chemical Gloves Grip - 8/M - 1pc	1	1	4932493229	4058546481001
Chemical Gloves Grip - 9/L - 1pc	1	1	4932493230	4058546481018
Chemical Gloves Grip - 10/XL - 1pc	1	1	4932493231	4058546481025
Chemical Gloves Grip - 11/XXL - 1pc	1	1	4932493232	4058546481032

Fully Dip Cut A Gloves

- Full hand double nitrile dipping to repel and don't absorb water or oils. First coating layer with smooth nitrile on full hand and second layer with Micro-thin foam on palm and thumb.
- Excellent grip performance with foam nitrile finish on the palm. Nitrile material performs better than others in wide range of temperatures and oily surfaces.
- Nitrile reinforcement coating on thumb to provide durability on a weak area.
- Designed to provide all-day comfort, ideal for manufacturing, plumbing, forestry, automotive and transportation, facility management.
- SMARTSWIPE™ fingertips - allows the use of touch screen devices without removing gloves.
- European Certified for cut protection and heat protection: EN ISO 21420, EN388:2016 (4221A), EN 407 (X1XXX).



Description	Packaging style	Pack quantity	Min. order quantity	Article Number	EAN Code
Fully Dip Cut A Gloves - 7/S - 1pc	Hang Card	1	1	4932493218	4058546480899
Pack Fully Dip Cut A Gloves - 7/S -12pc	Polybag	12	1	4932493223	4058546480943
Fully Dip Cut A Gloves - 8/M - 1pc	Hang Card	1	1	4932493219	4058546480905
Pack Fully Dip Cut A Gloves - 8/M - 12pc	Polybag	12	1	4932493224	4058546480950
Fully Dip Cut A Gloves - 9/L - 1pc	Hang Card	1	1	4932493220	4058546480912
Pack Fully Dip Cut A Gloves - 9/L - 12pc	Polybag	12	1	4932493225	4058546480967
Fully Dip Cut A Gloves - 10/XL - 1pc	Hang Card	1	1	4932493221	4058546480929
Pack Fully Dip Cut A Gloves - 10/XL -12pc	Polybag	12	1	4932493226	4058546480974
Fully Dip Cut A Gloves - 11/XXL - 1pc	Hang Card	1	1	4932493222	4058546480936
Pack Fully Dip Cut A Gloves - 11/XXL -12pc	Polybag	12	1	4932493227	4058546480981

Nitrile Disposable Gloves

- Durable and resistant disposable nitrile gloves with a thickness 8mil 0.2mm and weight of 8.0gr, reducing the risk of tear, break and increasing productivity.
- Diamond texture pattern to improve grip on metallic tools or in oily and greasy surfaces.
- Chemical resistant ideal to protects from oils, gasoline, thinners, brake fluids, solvents commonly used in automotive garages.
- Excellent dexterity to let users feel the working surface and handle very small parts.
- SMARTSWIPE™ fingertips - allows the use of touch screen devices without removing gloves.
- European Certified for chemical protection: EN ISO 374- 1:2016 Type B / KPT, EN ISO 374 -2, EN ISO 374-5 (VIRUS), EN ISO 21420, UKCA, EAC, UKRAINE



Description	Pack quantity	Min. order quantity	Article Number	EAN Code
Nitrile Disposable Gloves Grip - 7/S - 50pc	50pc	1	4932493233	4058546481049
Nitrile Disposable Gloves Grip - 8/M - 50pc	50pc	1	4932493234	4058546481056
Nitrile Disposable Gloves Grip - 9/L - 50pc	50pc	1	4932493235	4058546481063
Nitrile Disposable Gloves Grip - 10/XL - 50pc	50pc	1	4932493236	4058546481070
Nitrile Disposable Gloves Grip - 11/XXL - 50pc	50pc	1	4932493237	4058546481087



Chain saw Gloves

- Resistant saw cut protection in the right and left glove for forest work.
- Top grain goatskin leather grants extended durability and provides water repellent for working on wet environments.
- Reinforced palm, thumb-index and fingertips with dot pattern TPU for increased grip and durability.
- Smartswipe™ - Allows the use of touch screen devices without removing the gloves on the index finger knuckle.
- European Certified chainsaw protection EN ISO 11393 class 1 (20 m/s) and mechanical protection EN388:2016 (2122A) and EN ISO 21420.



Description	Pack quantity	Min. order quantity	Article Number	EAN Code
Chain Saw Gloves - 8/M - 1pc	1	1	4932493540	4058546484118
Chain Saw Gloves - 9/L - 1pc	1	1	4932493541	4058546484125
Chain Saw Gloves - 10/XL - 1pc	1	1	4932493542	4058546484132
Chain Saw Gloves - 11/XXL - 1pc	1	1	4932493543	4058546484149

DemoX Work Gloves

- Updated Demolition Gloves designed, versatile and comfortable work glove.
- ARMORTEX™ reinforced palms and fingertips: Increased durability and hand protection.
- SMARTSWIPE™ Knuckle: Allows the use of touch screen devices without removing the gloves on the index finger knuckle.
- Knuckle protection: TPR padding provides knuckle protection.
- Breathable tri-cot lining: Provides ultimate comfort and breathability.
- Terry cloth thumb: Built in sweat/brow wipe.
- Hook & Loop closure for secure fit.
- European Certified for mechanical protection: EN ISO 21420, EN388:2016 (2121A)



Description	Pack quantity	Min. order quantity	Article Number	EAN Code
DemoX Work Gloves - 7/S - 1pc	1	1	4932498486	4058546523558
DemoX Work Gloves - 8/M - 1pc	1	1	4932498487	4058546523565
DemoX Work Gloves - 9/L - 1pc	1	1	4932498488	4058546523572
DemoX Work Gloves - 10/XL - 1pc	1	1	4932498489	4058546523589
DemoX Work Gloves - 11/XXL - 1pc	1	1	4932498490	4058546523596

Impact Pro Cut C Gloves

- Impact resistant material on back of the hand and fingers reduces and absorbs shock.
- Reinforced nitrile coating with added protection between thumb and fingers.
- Excellent grip performance - nitrile material performs better than other materials in extreme temperatures and oily surfaces.
- SMARTSWIPE™ palm and fingertips - allows the use of touch screen devices without removing gloves.
- European Certified for cut protection including impact testing and heat protection: EN ISO 21420, EN388:2016 (4343CP), EN 407 (X1XXX).



Description	Pack quantity	Min. order quantity	Article Number	EAN Code
Impact Cut C Gloves - 11/XXL - 1pc	1	1	4932498533	4058546524029
Impact Cut C Gloves - 7/S - 1pc	1	1	4932498529	4058546523985
Impact Cut C Gloves - 8/M - 1pc	1	1	4932498530	4058546523992
Impact Cut C Gloves - 9/L - 1pc	1	1	4932498531	4058546524005
Impact Cut C Gloves - 10/XL - 1pc	1	1	4932498532	4058546524012

Impact Pro Cut E Gloves

- Impact resistant material on back of the hand and fingers reduces and absorbs shocks.
- Reinforced nitrile coating with added protection between thumb and fingers.
- Excellent grip performance - nitrile material performs better than other materials in extreme temperatures and oily surfaces.
- SMARTSWIPE™ palm and fingertips - allows the use of touch screen devices without removing gloves.
- European Certified for cut protection including impact testing and heat protection: EN ISO 21420, EN388:2016 (4X43EP), EN 407 (X1XXX).



Description	Pack quantity	Min. order quantity	Article Number	EAN Code
Impact Pro Cut E Gloves - 7/S - 1pc	1	1	4932498534	4058546524036
Impact Pro Cut E Gloves - 8/M - 1pc	1	1	4932498535	4058546524043
Impact Pro Cut E Gloves - 9/L - 1pc	1	1	4932498536	4058546524050
Impact Pro Cut E Gloves - 10/XL - 1pc	1	1	4932498537	4058546524067
Impact Pro Cut E Gloves - 11/XXL - 1pc	1	1	4932498538	4058546524074

Impact DemoX Work Gloves

- Updated Impact Demolition Gloves designed, durable work glove.
- Impact resistant material, on back of hand and fingers, to reduce and absorb shock.
- Reinforced palms and finger tips: Increased durability and improved grip.
- SMARTSWIPE™ Knuckle: Allows the use of touch screen devices without removing the gloves on the index finger knuckle.
- Hook & Loop closure for secure fit.
- European Certified for cut resistance protection including impact testing: EN ISO 21420 and EN388:2016 (2121AP).



Description	Pack quantity	Min. order quantity	Article Number	EAN Code
Impact DemoX Work Gloves - 7/S - 1pc	1	1	4932498481	4058546523503
Impact DemoX Work Gloves - 8/M - 1pc	1	1	4932498482	4058546523510
Impact DemoX Work Gloves - 9/L - 1pc	1	1	4932498483	4058546523527
Impact DemoX Work Gloves - 10/XL - 1pc	1	1	4932498484	4058546523534
Impact DemoX Work Gloves - 11/XXL - 1pc	1	1	4932498485	4058546523541

Performance Work Gloves

- Work gloves designed to provide comfort and dexterity for everyday task.
- SMARTSWIPE™ Knuckle: Allows the use of touch screen devices without removing the gloves on the index finger knuckle.
- Breathable tri-cot lining: Provides ultimate comfort and breathability.
- Terry cloth thumb: Built in sweat/brow wipe.
- Hook & Loop closure for secure fit.
- European Certified for mechanical protection: EN ISO 21420, EN388:2016 (2121A)



Description	Pack quantity	Min. order quantity	Article Number	EAN Code
Performance Work Gloves - 7/S - 1pc	1	1	4932498496	4058546523657
Performance Work Gloves - 8/M - 1pc	1	1	4932498497	4058546523664
Performance Work Gloves - 9/L - 1pc	1	1	4932498498	4058546523671
Performance Work Gloves - 10/XL - 1pc	1	1	4932498499	4058546523688
Performance Work Gloves - 11/XXL - 1pc	1	1	4932498500	4058546523695

Hybrid leather gloves

- Smartswipe™ - Allows the use of touch screen devices without removing the gloves on the index finger knuckle.
- Leather on the palm for extended durability and reinforced protection of hands.
- Synthetic leather on back of the hand to offer more dexterity and breathability while working.
- Reinforced palm for added comfort and protection while handling heavy objects.
- European Certified for cut resistance protection: EN ISO 21420 and EN388:2016 (2122X).



Description	Pack quantity	Min. order quantity	Article Number	EAN Code
Hybrid Leather Gloves - 7/S - 1pc	1	1	4932479726	4058546375201
Hybrid Leather Gloves - 8/M - 1pc	1	1	4932471912	4058546298111
Hybrid Leather Gloves - 9/L - 1pc	1	1	4932471913	4058546298128
Hybrid Leather Gloves - 10/XL - 1pc	1	1	4932471914	4058546298135
Hybrid Leather Gloves - 11/XXL - 1pc	1	1	4932471915	4058546298142

Leather Gloves

- Top grain goatskin leather gives extended durability and reinforced protection of hands.
- Reinforced palm provides added comfort and protection while handling heavy objects.
- Keystone thumb for comfortable fit and extended wear.
- Smartswipe™ - Allows the use of touch screen devices without removing the gloves on the index finger knuckle.
- European Certified for cut resistance protection: EN ISO 21420 and EN388:2016 (2122X).



Description	Pack quantity	Min. order quantity	Article Number	EAN Code
Leather Gloves - 7/S - 1pc	1	1	4932479727	4058546375218
Leather Gloves - 8/M - 1pc	1	1	4932478123	4058546340568
Leather Gloves - 9/L - 1pc	1	1	4932478124	4058546340575
Leather Gloves - 10/XL - 1pc	1	1	4932478125	4058546340582
Leather Gloves - 11/XXL - 1pc	1	1	4932478126	4058546340599

Winter Demolition Gloves

- Winter insulation and dual acrylic liner to keep the hand warm while working in cold conditions.
- Water and windproof layer on the palm provide superior insulation in extreme environments.
- Padded palm and fingertips for increased durability and comfort.
- SMARTSWIPE™ index finger knuckle that allows to use touch screen devices without removing gloves or using dirty fingertips.
- Built in sweat wipe with terry cloth on the thumb, to easily clean the glasses.
- European Certified for cut and cold resistance protection: EN ISO 21420, EN388:2016 (2122A), EN511 (14X), UKCA.



Description	Pack quantity	Min. order quantity	Article Number	EAN Code
Winter Demolition Gloves - 7/S - 1pc	1	1	4932479731	4058546375256
Winter Demolition Gloves - 8/M - 1pc	1	1	4932479566	4058546373603
Winter Demolition Gloves - 9/L - 1pc	1	1	4932479567	4058546373610
Winter Demolition Gloves - 10/XL - 1pc	1	1	4932479568	4058546373627
Winter Demolition Gloves - 11/XXL - 1pc	1	1	4932479569	4058546373634
Winter Demolition Gloves - 12/XXXL - 1pc	1	1	4932480976	4058546412616

Pad Pro Cut D Gloves

- Foam padding on the palm provides extra comfort to work with vibrating tools.
- 18 gauge material for extra dexterity on hands.
- Knuckle protection: TPR padding provides knuckle protection.
- Reinforced nitrile coating between thumb and fingers and superior puncture resistance for more durability.
- SMARTSWIPE™ palm and fingertips - allows the use of touch screen devices without removing gloves.
- European Certified for cut resistance protection: EN ISO 21420, EN388:2016 (4X42D), EN 407 (X1XXXX), UKCA.



Description	Pack quantity	Min. order quantity	Article Number	EAN Code
Pad Pro Cut D Gloves - 7/S - 1pc	1	1	4932498501	4058546523701
Pad Pro Cut D Gloves - 8/M - 1pc	1	1	4932498502	4058546523718
Pad Pro Cut D Gloves - 9/L - 1pc	1	1	4932498503	4058546523725
Pad Pro Cut D Gloves - 10/XL - 1pc	1	1	4932498504	4058546523732
Pad Pro Cut D Gloves - 11/XXL - 1pc	1	1	4932498505	4058546523749

Pad Pro Work Gloves

- Foam padding on the palm provides extra comfort to work with vibrating tools.
- Work gloves for heavy duty applications, like concrete drilling, grinding, sanding, cutting.
- Breathable lining: Provides ultimate comfort and breathability.
- Terry cloth thumb: Built in sweat/brow wipe.
- European Certified for cut resistance protection: EN ISO 21420, EN388:2016 (2121X), EN 407 (X1XXXX), UKCA.



Description	Pack quantity	Min. order quantity	Article Number	EAN Code
Pad Pro Work Gloves - 7/S - 1pc	1	1	4932498506	4058546523756
Pad Pro Work Gloves - 8/M - 1pc	1	1	4932498507	4058546523763
Pad Pro Work Gloves - 9/L - 1pc	1	1	4932498508	4058546523770
Pad Pro Work Gloves - 10/XL - 1pc	1	1	4932498509	4058546523787
Pad Pro Work Gloves - 11/XXL - 1pc	1	1	4932498510	4058546523794

Flex Work Gloves

- Lightweight and highly breathable general work gloves.
- Textile back of hand gives high dexterity and allows to handle small objects.
- Soft synthetic leather on the palm for handling delicate materials.
- Reinforced thumb and fingers seam for more durability.
- Built-in sweat-wipe on thumb finger.
- SMARTSWIPE™ knuckle and fingertips, allows the use of touch screen devices without removing the gloves.
- European Certified for mechanical protection: EN ISO 21420, EN388:2016 (2121A).



Description	Pack quantity	Min. order quantity	Article Number	EAN Code
Flex Work Gloves - 7/S - 1pc	1	1	4932498491	4058546523602
Flex Work Gloves - 8/M - 1pc	1	1	4932498492	4058546523619
Flex Work Gloves - 9/L - 1pc	1	1	4932498493	4058546523626
Flex Work Gloves - 10/XL - 1pc	1	1	4932498494	4058546523633
Flex Work Gloves - 11/XXL - 1pc	1	1	4932498495	4058546523640

TOOL DROP PREVENTION

MILWAUKEE® LANYARDS

WHY MILWAUKEE® LANYARDS?

A FALLING OBJECT IS THE 3RD HIGHEST CAUSE OF FATALITY ON A JOBSITE.

(Peoplesafe.co.uk, 2019)

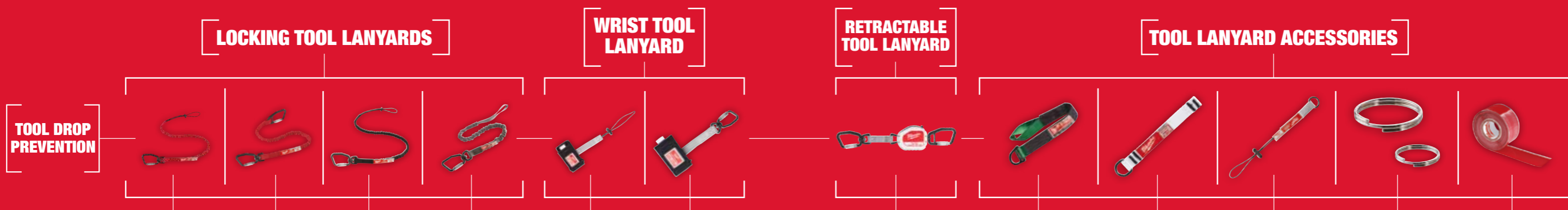

NAME	4.5 KG LOCKING TOOL LANYARD	4.5 KG QUICK CONNECT LOCKING TOOL LANYARD	6.8 KG LOCKING TOOL LANYARD	15.8 KG LOCKING TOOL LANYARD	WRIST LANYARD	QUICK CONNECT WRIST LANYARD	RETRACTABLE TOOL LANYARD	ANCHORING STRAP	D-RING WEB	SMALL QUICK CONNECT	SPLIT RINGS 38 mm / 50 mm	SELF-ADHERING TAPE 3.6 m
PART NUMBER	4932471351	4932471429	4932471352	4932471353	4932472107	4932472108	4932472106	4932472105	4932471431	4932471430	4932471433 (38 mm) 4932471434 (50 mm)	48228860
WEIGHT CAPACITY	4.5 KG	4.5 KG	6.8 KG	15.8 KG	2.2 KG	2.2 KG	2.2 KG	22.7 KG	2.2 KG	2.2 KG	1 KG	-
COLOUR CODING	RED	RED	BLACK	GREY	WHITE	WHITE	WHITE	GREEN	WHITE	WHITE	-	-
TETHER MECHANISM											-	-
COMPATIBLE WITH	ANCHORING STRAP	ALL ACCESSORIES	ANCHORING STRAP	ANCHORING STRAP	-	-	ALL ACCESSORIES	ALL LOCKING TOOL LANYARDS	SELF-ADHERING TAPE & 4.5 KG QUICK CONNECT LOCKING TOOL LANYARD	4.5 KG QUICK CONNECT LOCKING TOOL LANYARD	4.5 KG QUICK CONNECT LOCKING TOOL LANYARD	D-RING WEB
INTEGRATED SWIVEL	✓	✓	✓	✓	-	-	✓	-	-	-	-	-
SUITABLE PRODUCTS*	DRILL DRIVER IMPACT DRIVER IMPACT WRENCH JIGSAW HACKZALL SAWZALL™ SHEARS	HANDTOOLS WITH LANYARD ACCESSORY ATTACHED	ANGLE GRINDER DRILL DRIVER IMPACT DRIVER IMPACT WRENCH SDS PLUS HACKZALL SAWZALL™ BANDSAWS	SDS PLUS SDS MAX MAG PRESS IMPACT WRENCH BANDSAWS CHAINSAW	DRILL DRIVERS IMPACT DRIVERS IMPACT WRENCH HANDTOOLS	DRILL DRIVERS IMPACT DRIVERS IMPACT WRENCH HANDTOOLS	DRILL DRIVERS IMPACT DRIVERS IMPACT WRENCH HANDTOOLS	ALL LOCKING TOOL LANYARDS	HANDTOOLS WITHOUT LANYARD HOLE HAMMERS CUTTERS PLIERS	HANDTOOLS WITH LANYARD HOLE SCREWDRIVERS TAPES PLIERS	HANDTOOL WITH LANYARD HOLE KNIVES TAPES PLIERS	D-RING WEB
APPLICATION												

*All product recommendations are only references and are not guaranteed!
Please make sure that the total weight of the tethered product (+ Battery) does not exceed the weight capacity of the tool lanyard!



Locking tool lanyards

- Superior shock absorption - gradually stop the tool if dropped.
- Double locking carabiner - ensures a secure connection that cannot become loose or slip off accidentally.
- Integrated swivel - prevents twists and tangles allowing increased mobility.
- Colour coded weight rating - easy identification of lanyard weight capacity.
- High versatility - lanyard accessories can be added to connect all tools to the lanyards.



Description	Bearing force (kg)	Colour code	Pack quantity	Min. order quantity	Article Number	EAN Code
① 4.5 kg locking tool lanyard	4.5	Red	1	1	4932471351	4058546289799
② 4.5 kg QUICK-CONNECT™ locking tool lanyard	4.5	Red	1	1	4932471429	4058546290573
③ 6.8 kg locking tool lanyard	6.8	Black	1	1	4932471352	4058546289805
④ 15.8 kg locking tool lanyard	15.8	Grey	1	1	4932471353	4058546289812



TOOL LANYARD ACCESSORIES

STAY SAFE. SECURE ANY TOOL.

EASILY CONNECT

- Creates a secure attachment point
- Different connection system (self-adhering tape or rings)

HIGH VERSATILITY

- Possibility to connect tools with or without lanyard holes
- Allows fast tool swap



Tool lanyard accessories

Description	Colour code	Bearing force (kg)	Pack quantity	Min. order quantity	Article Number	EAN Code
① 2.2 kg small QUICK-CONNECT™ accessory	White	2.2	3	1	4932471430	4058546290580
② 2.2 kg D-ring web attachment	White	2.2	5	1	4932471431	4058546290597
③ 3.6 m self-adhering tape	-	-	1	1	48228860	4058546290603
④ 38 mm split ring	-	1	5	1	4932471433	4058546290610
⑤ 50 mm split ring	-	1	5	1	4932471434	4058546290627
⑥ Anchoring strap	Green	22.7	1	1	4932472105	4058546325015

Retractable tool lanyard

- Automatically retracts, 127 cm when extended.
- Double locking carabiner - ensures a secure connection that cannot become loose or slip off accidentally.
- Shuttle lock - greater control during use.
- Integrated swivel - prevents twists and tangles allowing increased mobility.
- Colour coded weight rating - easy identification of lanyard weight capacity.
- High versatility - lanyard accessories can be added to connect all tools to the lanyards.



Description	Colour code	Pack quantity	Min. order quantity	Article Number	EAN Code
2.2 kg Quick-Connect Retractable Tool Lanyard	White	1	1	4932472106	4058546325022

Wrist tool lanyard

- Secure and comfortable tools attachment to the wrist.
- Soft and adjustable strap - fits all wrist sizes with a hook and loop closure.
- Hang loop or quick-connect double locking carabiner to securely attach all kind of tools - power tools, tapes, screwdrivers, etc.
- Wrist lanyard allows an easy access to tools in a tight environment or in repetitive work.
- Colour coded weight rating - easy identification of lanyard weight capacity.

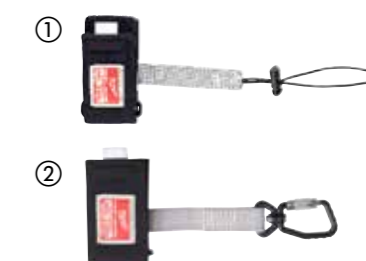

Description	Bearing force (kg)	Colour code	Pack quantity	Min. order quantity	Article Number	EAN Code
① Wrist lanyard	2.2	White	1	1	4932472107	4058546325039
② Quick connect wrist lanyard	2.2	White	1	1	4932472108	4058546325046

STAYS WARMER FOR LONGER

GREATEST
HEAT
COVERAGE

HEXON
HEAT TECHNOLOGY™

FASTEST
HEAT-UP
TIME

DURABLE CARBON NANOTUBE
HEATING ELEMENTS

HIGHER SUSTAINED HEAT NO
MATTER THE TEMPERATURE

FASTEST HEAT UP TIME IN
LESS THAN 2 MINUTES

LED CONTROLLER WITH 3
HEAT SETTINGS PER ZONE

PREVIOUS
GENERATION

HEXON
HEAT TECHNOLOGY™

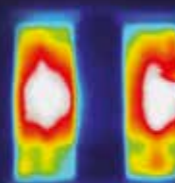

VIEW THE FULL RANGE HERE

MILWAUKEE HEATED GEAR RANGE

Powered by M12™ REDLITHIUM™ / REDLITHIUM™ USB battery technology or the MILWAUKEE® Flat Pack Battery to access the Heated Gear App features, MILWAUKEE® HEXON Heated Work Gear distributes heat across core body areas. Durable carbon nanotube heating elements have a 40x greater heat coverage than the previous generation and a 9x faster heat up speed. LED controller with 3 heat settings per zone to conveniently adjust to user needs.

EXPLORE OUR RANGE
OF HEATED GEAR



M12™ Heated Jacket

NEW

- HEXON HEAT TECHNOLOGY™ provides superior heat experience with a faster heat up speed and superior heat coverage
- All day run time, up to 12 hours with a single battery charge of M12™ REDLITHIUM™ 3.0Ah battery
- 5 Heat Zones: Chest, Back and Pockets
- Easy touch heat controller - 3 heat settings: High, Medium, Low
- IRPSU3 Heated Gear Flat Power Source compatibility providing comfort and enabling app control
- TOUGHShell™ stretch 90% polyester and 10% spandex material to withstand harsh working conditions and deliver up to 5x longer life
- Zippered battery pass-through pocket: Position the battery in the front or back pocket to improve comfort
- Water and wind resistant, provides comfort and durability in harsh environments
- Adjustable waist drawcord and cuffs keep heat in
- Flexible battery system: works with all MILWAUKEE® M12™ batteries
- Washer and dryer safe



Description	Size	Colour	Pack quantity	Min. order quantity	Article Number	EAN Code
M12™ Heated Jacket black	S	Black	1	1	4932493819	4058546509798
M12™ Heated Jacket black	M	Black	1	1	4932493820	4058546509804
M12™ Heated Jacket black	L	Black	1	1	4932493821	4058546509811
M12™ Heated Jacket black	XL	Black	1	1	4932493822	4058546509828
M12™ Heated Jacket black	XXL	Black	1	1	4932493823	4058546509835
M12™ Heated Jacket black	XXXL	Black	1	1	4932493824	4058546509842
M12™ Heated Jacket grey	S	Grey	1	1	4932493825	4058546509859
M12™ Heated Jacket grey	M	Grey	1	1	4932493826	4058546509866
M12™ Heated Jacket grey	L	Grey	1	1	4932493827	4058546509873
M12™ Heated Jacket grey	XL	Grey	1	1	4932493828	4058546509880
M12™ Heated Jacket grey	XXL	Grey	1	1	4932493829	4058546509897
M12™ Heated Jacket grey	XXXL	Grey	1	1	4932493830	4058546509903

M12™ Heated Jacket

NEW

- HEXON HEAT TECHNOLOGY™ provides superior heat experience with a faster heat up speed and superior heat coverage
- All day run time, up to 12 hours with a single battery charge of M12™ REDLITHIUM™ 3.0Ah battery
- 5 Heat Zones: Chest, Back and Pockets
- Easy touch heat controller - 3 heat settings: High, Medium, Low
- IRPSU3 Heated Gear Flat Power Source compatibility providing comfort and enabling app control
- REALTREE EDGE® QUIETSHELL stretch polyester fabric protects from harsh jobsite conditions while reducing noise from movement
- Zippered battery pass-through pocket: Position the battery in the front or back pocket to improve comfort
- Water and wind resistant, provides comfort and durability in harsh environments
- Adjustable waist drawcord and cuffs keep heat in
- Flexible battery system: works with all MILWAUKEE® M12™ batteries
- Washer and dryer safe



Description	Size	Colour	Pack quantity	Min. order quantity	Article Number	EAN Code
M12™ Heated Jacket camo	S	Camouflage	1	1	4932493831	4058546509910
M12™ Heated Jacket camo	M	Camouflage	1	1	4932493832	4058546509927
M12™ Heated Jacket camo	L	Camouflage	1	1	4932493833	4058546509934
M12™ Heated Jacket camo	XL	Camouflage	1	1	4932493834	4058546509941
M12™ Heated Jacket camo	XXL	Camouflage	1	1	4932493835	4058546509958
M12™ Heated Jacket camo	XXXL	Camouflage	1	1	4932493836	4058546509965

M12™ Heated Puffer Jacket black

NEW

- HEXON HEAT TECHNOLOGY™ provides superior heat experience with a faster heat up speed and superior heat coverage
- All day run time, up to 12 hours with a single battery charge of M12™REDLITHIUM™ 3.0Ah battery
- 5 Heat Zones: Chest, Back and Shoulders
- Easy touch heat controller - 3 heat settings: High, Medium, Low
- IRPSU3 Heated Gear Flat Power Source compatibility providing comfort and enabling app control
- Lightweight and highly durable ripstop polyester provides a slim design that can be worn as an outer-shell or a mid-layer (100% Polyester outer and inner shell)
- Zippered battery pass-through pocket: Position the battery in the front or back pocket to improve comfort
- Water and wind resistant, provides comfort and durability in harsh environments
- Adjustable waist drawcord keep heat in
- Flexible battery system: works with all MILWAUKEEMILWAUKEE®M12™ batteries
- Washer and dryer safe



Description	Size	Colour	Pack quantity	Min. order quantity	Article Number	EAN Code
M12™Heated Puffer Jacket black	S	Black	1	1	4932493837	4058546509972
M12™Heated Puffer Jacket black	M	Black	1	1	4932493838	4058546509989
M12™Heated Puffer Jacket black	L	Black	1	1	4932493839	4058546509996
M12™Heated Puffer Jacket black	XL	Black	1	1	4932493840	4058546510008
M12™Heated Puffer Jacket black	XXL	Black	1	1	4932493841	4058546510015

M12™ Heated Puffer Jacket Ladies black

NEW

- HEXON HEAT TECHNOLOGY™ provides superior heat experience with a faster heat up speed and superior heat coverage
- All day run time, up to 12 hours with a single battery charge of M12™REDLITHIUM™ 3.0Ah battery
- 5 Heat Zones: Chest, Back and Shoulders
- Easy touch heat controller - 3 heat settings: High, Medium, Low
- IRPSU3 Heated Gear Flat Power Source compatibility providing comfort and enabling app control
- Lightweight and highly durable ripstop polyester provides a slim design that can be worn as an outer-shell or a mid-layer (100% Polyester outer and inner shell)
- Zippered battery pass-through pocket: Position the battery in the front or back pocket to improve comfort
- Water and wind resistant, provides comfort and durability in harsh environments
- Adjustable waist drawcord keep heat in
- Flexible battery system: works with all MILWAUKEEMILWAUKEE®M12™ batteries
- Washer and dryer safe



Description	Size	Colour	Pack quantity	Min. order quantity	Article Number	EAN Code
M12™Heated Puffer Jacket Ladies black	S	Black	1	1	4932493847	4058546510077
M12™Heated Puffer Jacket Ladies black	M	Black	1	1	4932493848	4058546510084
M12™Heated Puffer Jacket Ladies black	L	Black	1	1	4932493849	4058546510091
M12™Heated Puffer Jacket Ladies black	XL	Black	1	1	4932493850	4058546510107
M12™Heated Puffer Jacket Ladies black	XXL	Black	1	1	4932493851	4058546510114

M12™ Heated Puffer Vest black

NEW

- HEXON HEAT TECHNOLOGY™ provides superior heat experience with a faster heat up speed and superior heat coverage
- All day run time, up to 11 hours with a single battery charge of M12™REDLITHIUM™ 3.0Ah battery
- 3 Heat Zones: Chest and Back
- Easy touch heat controller - 3 heat settings: High, Medium, Low
- IRPSU3 Heated Gear Flat Power Source compatibility providing comfort and enabling app control
- Lightweight and highly durable ripstop polyester provides a slim design that can be worn as an outer-shell or a mid-layer (100% Polyester outer and inner shell)
- Zippered battery pass-through pocket: Position the battery in the front or back pocket to improve comfort
- Water and wind resistant, provides comfort and durability in harsh environments
- Adjustable waist drawcord keep heat in
- Flexible battery system: works with all MILWAUKEEMILWAUKEE®M12™ batteries
- Washer and dryer safe



Description	Size	Colour	Pack quantity	Min. order quantity	Article Number	EAN Code
M12™Heated Puffer Vest black	S	Black	1	1	4932493842	4058546510022
M12™Heated Puffer Vest black	M	Black	1	1	4932493843	4058546510039
M12™Heated Puffer Vest black	L	Black	1	1	4932493844	4058546510046
M12™Heated Puffer Vest black	XL	Black	1	1	4932493845	4058546510053
M12™Heated Puffer Vest black	XXL	Black	1	1	4932493846	4058546510060

M12™ Heated Puffer Vest Ladies black

NEW

- HEXON HEAT TECHNOLOGY™ provides superior heat experience with a faster heat up speed and superior heat coverage
- All day run time, up to 11 hours with a single battery charge of M12™REDLITHIUM™ 3.0Ah battery
- 3 Heat Zones: Chest and Back
- Easy touch heat controller - 3 heat settings: High, Medium, Low
- IRPSU3 Heated Gear Flat Power Source compatibility providing comfort and enabling app control
- Lightweight and highly durable ripstop polyester provides a slim design that can be worn as an outer-shell or a mid-layer (100% Polyester outer and inner shell)
- Zippered battery pass-through pocket: Position the battery in the front or back pocket to improve comfort
- Water and wind resistant, provides comfort and durability in harsh environments
- Adjustable waist drawcord keep heat in
- Flexible battery system: works with all MILWAUKEEMILWAUKEE®M12™ batteries
- Washer and dryer safe



Description	Size	Colour	Pack quantity	Min. order quantity	Article Number	EAN Code
M12™Heated Puffer Vest Ladies black	S	Black	1	1	4932493852	4058546510121
M12™Heated Puffer Vest Ladies black	M	Black	1	1	4932493853	4058546510138
M12™Heated Puffer Vest Ladies black	L	Black	1	1	4932493854	4058546510145
M12™Heated Puffer Vest Ladies black	XL	Black	1	1	4932493855	4058546510152
M12™Heated Puffer Vest Ladies black	XXL	Black	1	1	4932493856	4058546510169

M12™ Heated Hoodie

NEW

- HEXON HEAT TECHNOLOGY™ provides superior heat experience with a faster heat up speed and superior heat coverage
- All day run time, up to 11 hours with a single battery charge of M12™ REDLITHIUM™ 3.0Ah battery
- 3 Heat Zones: Chest and Back
- Easy touch heat controller - 3 heat settings: High, Medium, Low
- IRPSU3 Heated Gear Flat Power Source compatibility providing comfort and enabling app control
- Rugged heated hoodie made from durable cotton (56%) exterior with durable reinforced utility pockets and polyester fleece (44%) lining to withstand tough outdoor conditions
- Zippered battery pass-through pocket: Position the battery in the front or back pocket to improve comfort
- Three-panel hood design with drawcord for comfortable fit
- Flexible battery system: works with all MILWAUKEE® M12™ batteries
- Washer and dryer safe



Description	Size	Colour	Pack quantity	Min. order quantity	Article Number	EAN Code
M12™ Heated Hoodie black	S	Black	1	1	4932499187	4058546563516
M12™ Heated Hoodie black	M	Black	1	1	4932499188	4058546563523
M12™ Heated Hoodie black	L	Black	1	1	4932499189	4058546563530
M12™ Heated Hoodie black	XL	Black	1	1	4932499190	4058546563547
M12™ Heated Hoodie black	XXL	Black	1	1	4932499191	4058546563554
M12™ Heated Hoodie black	XXXL	Black	1	1	4932499192	4058546563561

FREEFLEX™ Softshell Hooded Jacket Black

- FREEFLEX™ Mobility: Engineered To Move Freely On The Job with a custom 2-way stretch fabric and full range arm movement for working overhead.
- Wind and Water-Resistant Materials: Built to protect against changing jobsite conditions.
- Brushed Fleece Interior: Provides the warmth for early morning jobs without adding bulk.
- Hidden Draw Cords: Stay out of the way when ripping cuts.
- Double-Stitched Reinforced 3-Pocket Design: Allows for added tool storage and functionality.
- Durable Rib Knit Cuffs: Comfortable elastic cuffs shield from wind and are easy to layer without gloves.



Description	Size	Pack quantity	Min. order quantity	Article Number	EAN Code
FREEFLEX™ Softshell Hooded Jacket Black	S	1	1	4932498271	4058546521400
FREEFLEX™ Softshell Hooded Jacket Black	M	1	1	4932498272	4058546521417
FREEFLEX™ Softshell Hooded Jacket Black	L	1	1	4932498273	4058546521424
FREEFLEX™ Softshell Hooded Jacket Black	XL	1	1	4932498274	4058546521431
FREEFLEX™ Softshell Hooded Jacket Black	XXL	1	1	4932498275	4058546521448
FREEFLEX™ Softshell Hooded Jacket Black	XXXL	1	1	4932498276	4058546521455

Heated gear power source

NEW

- Powers all M12™ Heated Gear
- USB-C bi-directional charging delivers 15A to charge devices and 36W to re-charge the power source
- Bluetooth connectivity with the MILWAUKEE® Heated Gear app
- 36Wh battery capacity
- Up to 12 hours runtime with M12™ Heated Gear
- Simultaneously power M12™ Heated Gear while charging a device or the power supply
- Select your desired runtime, customise heat levels and zones and save favourites for quick-access in the MILWAUKEE® Heated Gear app
- Personalise heat zones and runtime when paired with HEXON heat technology™ garments



Description	Battery pack capacity (Ah)	Battery type	Pack quantity	Min. order quantity	Article Number	EAN Code
Heated gear power source	3	Li-ion	1	1	4932492907	4058546477783



FREEFLEX™ Work Jacket Black

- FREEFLEX™ Engineered to move freely on the job: Custom action back design paired with a full range arm movement.
- Insulated Quilted Lining: Provides warmth needed to keep working all winter without adding bulk.
- Jobsite Durability: Ripstop reinforced elbows and shoulders protect while working.
- Double-stitched reinforced 6-pocket design: allows for added tool storage and functionality.
- Zippers built for the jobsite: shielded front zipper design holds up against jobsite debris.
- Adjustable snap cuffs: allow for seamless and comfortable fitting with work gloves.



Description	Size	Pack quantity	Min. order quantity	Article Number	EAN Code
FREEFLEX™ Work Jacket Black	S	1	1	4932498277	4058546521462
FREEFLEX™ Work Jacket Black	M	1	1	4932498278	4058546521479
FREEFLEX™ Work Jacket Black	L	1	1	4932498279	4058546521486
FREEFLEX™ Work Jacket Black	XL	1	1	4932498280	4058546521493
FREEFLEX™ Work Jacket Black	XXL	1	1	4932498281	4058546521509
FREEFLEX™ Work Jacket Black	XXXL	1	1	4932498282	4058546521516

GRIDIRON™ Full-Zip Hoodie

- Made from durable, light, and breathable fabric for all-day protection to outlast the job
- Built with a tear- and abrasion-resistant 55/45 cotton/poly blend
- Trade focused features consisting of large front pockets with wide reinforced edges and easy entrance
- 3-panel hood with hidden draw cords providing safety on the job
- Hidden device pocket inside the front pocket

Description	Colour	Size	Pack quantity	Min. order quantity	Article Number	EAN Code
GRIDIRON™ Full-Zip Hoodie Black	Black	S	1	1	4932499387	4058546565510
	Black	M	1	1	4932499388	4058546565527
	Black	L	1	1	4932499389	4058546565534
	Black	XL	1	1	4932499390	4058546565541
	Black	XXL	1	1	4932499391	4058546565558
	Black	XXXL	1	1	4932499392	4058546565565
GRIDIRON™ Full-Zip Hoodie Grey	Grey	S	1	1	4932499393	4058546565572
	Grey	M	1	1	4932499394	4058546565589
	Grey	L	1	1	4932499395	4058546565596
	Grey	XL	1	1	4932499396	4058546565602
	Grey	XXL	1	1	4932499397	4058546565619
	Grey	XXXL	1	1	4932499398	4058546565626
GRIDIRON™ Full-Zip Hoodie Blue	Blue	S	1	1	4932499399	4058546565633
	Blue	M	1	1	4932499400	4058546565640
	Blue	L	1	1	4932499401	4058546565657
	Blue	XL	1	1	4932499402	4058546565664
	Blue	XXL	1	1	4932499403	4058546565671
	Blue	XXXL	1	1	4932499404	4058546565688



Midweight Hoodie

- Midweight hoodie is easy to layer for great seasonal versatility.
- Trade focused design with reinforced front pockets and drop shoulder seams.
- Comfortable design and fit allows to move freely and easily on the job.

Description	Colour	Size	Pack quantity	Min. order quantity	Article Number	EAN Code
① Work hoodie midweight - black	Black	S	1	1	4932493116	4058546479879
	Black	M	1	1	4932493117	4058546479886
	Black	L	1	1	4932493118	4058546479893
	Black	XL	1	1	4932493119	4058546479909
	Black	XXL	1	1	4932493120	4058546479916
② Work hoodie midweight - grey	Grey	S	1	1	4932493121	4058546479923
	Grey	M	1	1	4932493122	4058546479930
	Grey	L	1	1	4932493123	4058546479947
③ Work hoodie midweight - blue	Grey	XL	1	1	4932493124	4058546479954
	Grey	XXL	1	1	4932493125	4058546479961
	Blue	S	1	1	4932493126	4058546479978
	Blue	M	1	1	4932493127	4058546479985
	Blue	L	1	1	4932493128	4058546479992
④ Work hoodie midweight - brown	Blue	XL	1	1	4932493129	4058546480004
	Blue	XXL	1	1	4932493130	4058546480011
	Brown	S	1	1	4932493131	4058546480028
	Brown	M	1	1	4932493132	4058546480035
	Brown	L	1	1	4932493133	4058546480042
	Brown	XL	1	1	4932493134	4058546480059
	Brown	XXL	1	1	4932493135	4058546480066



Work T-Shirt Summary Table

- Heavy Duty 200 gsm tear and abrasion resistant fabric, perfectly to outlast the jobsite.
- Durable and breathable cotton (60) polyester (40) blend.
- Storage pocket to store pens, ear plugs or other items.
- UV Protection Factor UPF 50+ according to EN 13758-1.

Description	Colour	Size	Pack quantity	Min. order quantity	Article Number	EAN Code
① Work T-Shirt short sleeve black	Black	S	1	1	4932493003	4058546478742
	Black	M	1	1	4932493004	4058546478759
	Black	L	1	1	4932493005	4058546478766
	Black	XL	1	1	4932493006	4058546478773
	Black	XXL	1	1	4932493007	4058546478780
② Work T-Shirt long sleeve black	Black	S	1	1	4932493033	4058546479046
	Black	M	1	1	4932493034	4058546479053
	Black	L	1	1	4932493035	4058546479060
③ Work T-Shirt short sleeve blue	Black	XL	1	1	4932493036	4058546479077
	Black	XXL	1	1	4932493037	4058546479084
	Blue	S	1	1	4932493013	4058546478841
	Blue	M	1	1	4932493014	4058546478858
	Blue	L	1	1	4932493015	4058546478865
	Blue	XL	1	1	4932493016	4058546478872
④ Work T-Shirt long sleeve blue	Blue	XXL	1	1	4932493017	4058546478889
	Blue	S	1	1	4932493043	4058546479145
	Blue	M	1	1	4932493044	4058546479152
	Blue	L	1	1	4932493045	4058546479169
	Blue	XL	1	1	4932493046	4058546479176
⑤ Work T-Shirt short sleeve green	Blue	XXL	1	1	4932493047	4058546479183
	Green	S	1	1	4932493018	4058546478896
	Green	M	1	1	4932493019	4058546478902
	Green	L	1	1	4932493020	4058546478919
	Green	XL	1	1	4932493021	4058546478926
	Green	XXL	1	1	4932493022	4058546478933
⑥ Work T-Shirt long sleeve green	Green	S	1	1	4932493048	4058546479190
	Green	M	1	1	4932493049	4058546479206
	Green	L	1	1	4932493040	4058546479114
	Green	XL	1	1	4932493041	4058546479121
	Green	XXL	1	1	4932493042	4058546479138
⑦ Work T-Shirt short sleeve brown	Brown	S	1	1	4932493028	4058546478995
	Brown	M	1	1	4932493029	4058546479008
	Brown	L	1	1	4932493030	4058546479015
	Brown	XL	1	1	4932493031	4058546479022
⑧ Work T-shirt long sleeve brown	Brown	XXL	1	1	4932493032	4058546479039
	Brown	S	1	1	4932493058	4058546479299
	Brown	M	1	1	4932493059	4058546479305
	Brown	L	1	1	4932493060	4058546479312
	Brown	XL	1	1	4932493061	4058546479329
	Brown	XXL	1	1	4932493062	4058546479336



Hybrid T-Shirt Summary Table

- Lightweight and breathable 156 gsm work shirt to stay comfortable and productive.
- Specifically created for mobility with drop shoulder design and full body coverage.
- Breathable and comfortable cotton (33) polyester (67) blend.

	Description	Colour	Size	Pack quantity	Min. order quantity	Article Number	EAN Code
①	Hybrid T-shirt short sleeve black	Black	S	1	1	4932492963	4058546478346
		Black	M	1	1	4932492964	4058546478353
		Black	L	1	1	4932492965	4058546478360
		Black	XL	1	1	4932492966	4058546478377
		Black	XXL	1	1	4932492967	4058546478384
②	Hybrid T-shirt long sleeve black	Black	S	1	1	4932492983	4058546478544
		Black	M	1	1	4932492984	4058546478551
		Black	L	1	1	4932492985	4058546478568
		Black	XL	1	1	4932492986	4058546478575
		Black	XXL	1	1	4932492987	4058546478582
③	Hybrid T-shirt short sleeve	Grey	S	1	1	4932492968	4058546478391
		Grey	M	1	1	4932492969	4058546478407
		Grey	L	1	1	4932492970	4058546478414
		Grey	XL	1	1	4932492971	4058546478421
		Grey	XXL	1	1	4932492972	4058546478438
④	Hybrid T-shirt long sleeve	Grey	S	1	1	4932492988	4058546478599
		Grey	M	1	1	4932492989	4058546478605
		Grey	L	1	1	4932492990	4058546478612
		Grey	XL	1	1	4932492991	4058546478629
		Grey	XXL	1	1	4932492992	4058546478636
⑤	Hybrid T-shirt short sleeve blue	Blue	S	1	1	4932492973	4058546478445
		Blue	M	1	1	4932492974	4058546478452
		Blue	L	1	1	4932492975	4058546478469
		Blue	XL	1	1	4932492976	4058546478476
		Blue	XXL	1	1	4932492977	4058546478483
⑥	Hybrid T-shirt long sleeve blue	Blue	S	1	1	4932492993	4058546478643
		Blue	M	1	1	4932492994	4058546478650
		Blue	L	1	1	4932492995	4058546478667
		Blue	XL	1	1	4932492996	4058546478674
		Blue	XXL	1	1	4932492997	4058546478681
⑦	Hybrid T-shirt short sleeve green	Green	S	1	1	4932492978	4058546478490
		Green	M	1	1	4932492979	4058546478506
		Green	L	1	1	4932492980	4058546478513
		Green	XL	1	1	4932492981	4058546478520
		Green	XXL	1	1	4932492982	4058546478537
⑧	Hybrid T-shirt long sleeve green	Green	S	1	1	4932492998	4058546478698
		Green	M	1	1	4932492999	4058546478704
		Green	L	1	1	4932493000	4058546478711
		Green	XL	1	1	4932493001	4058546478728
		Green	XXL	1	1	4932493002	4058546478735



Warm Weather T-Shirt Summary Table

- Light weight to stay productive on the jobsite in hot weather conditions
- Moisture wicking fabric, 100% Polyester
- Fast-drying, multi-layer mesh material in core sweat zones for great ventilation under the armpits, on the sides of the body and on the back
- Raglan sleeves for comfortable carrying of tool bags, backpacks or climbing harnesses and providing a greater range of motion
- UV Protection Factor UPF 50+ according to EN 13758-1.

	Description	Colour	Size	Pack quantity	Min. order quantity	Article Number	EAN Code
①	WORKSKIN™ warm weather short sleeve performance shirt black	Black	S	1	1	4932493063	4058546479343
		Black	M	1	1	4932493064	4058546479350
		Black	L	1	1	4932493065	4058546479367
		Black	XL	1	1	4932493066	4058546479374
		Black	XXL	1	1	4932493067	4058546479381
②	WORKSKIN™ warm weather long sleeve performance shirt black	Black	S	1	1	4932493078	4058546479497
		Black	M	1	1	4932493079	4058546479503
		Black	L	1	1	4932493080	4058546479510
		Black	XL	1	1	4932493081	4058546479527
		Black	XXL	1	1	4932493082	4058546479534
③	WORKSKIN™ warm weather short sleeve performance shirt red	Red	S	1	1	4932493068	4058546479398
		Red	M	1	1	4932493069	4058546479404
		Red	L	1	1	4932493070	4058546479411
		Red	XL	1	1	4932493071	4058546479428
		Red	XXL	1	1	4932493072	4058546479435
④	WORKSKIN™ warm weather long sleeve performance shirt red	Red	S	1	1	4932493083	4058546479541
		Red	M	1	1	4932493084	4058546479558
		Red	L	1	1	4932493085	4058546479565
		Red	XL	1	1	4932493086	4058546479572
		Red	XXL	1	1	4932493087	4058546479589
⑤	Warm weather short sleeve performance shirt - yellow	Yellow	S	1	1	4932493073	4058546479442
		Yellow	M	1	1	4932493074	4058546479459
		Yellow	L	1	1	4932493075	4058546479466
		Yellow	XL	1	1	4932493076	4058546479473
		Yellow	XXL	1	1	4932493077	4058546479480
⑥	Warm weather long sleeve performance shirt - yellow	Yellow	S	1	1	4932493088	4058546479596
		Yellow	M	1	1	4932493089	4058546479602
		Yellow	L	1	1	4932493090	4058546479619
		Yellow	XL	1	1	4932493091	4058546479626
		Yellow	XXL	1	1	4932493092	4058546479633
⑦	WORKSKIN™ light weight performance short sleeve shirt - Grey	Grey	S	1	1	4933478194	4058546341275
		Grey	M	1	1	4933478195	4058546341282
		Grey	L	1	1	4933478196	4058546341299
		Grey	XL	1	1	4933478197	4058546341305
		Grey	XXL	1	1	4933478198	4058546341312
⑧	WORKSKIN™ light weight performance long sleeve shirt - Grey	Grey	S	1	1	4933464108	4058546220532
		Grey	M	1	1	4933464194	4058546221393
		Grey	L	1	1	4933464195	4058546221409
		Grey	XL	1	1	4933464196	4058546221416
		Grey	XXL	1	1	4933464197	4058546221423



FREEFLEX™ Work Pants black

- FREEFLEX™ Mobility: Comfortable 4-way stretch material in key movement areas allows maximum range of motion even when loaded with tools.
- Durable mid weight 245 gsm material (65% recycled Polyester / 35% cotton) ideal for indoor and outdoor applications.
- Removable and reinforced holster pockets with loops for more storage versatility (secured with zip and buttons).
- Diagonally opened side pocket to store longer tools (meter stick, pliers, spanners) with additional storage for smaller tools.
- 2x closable side pockets with loops, 2x front pockets and 2x closable back pockets.
- Cordura® reinforced knee pad pockets with flaps to protect against dust and dirt.
- Tool lanyard ready for working safely at height.
- Hammer loop for quick access to hammers.
- The trouser length can be extended by 5 cm at the bottom for maximum adjustment.
- OEKO-TEX® made in green.



Description	Size	Pack quantity	Min. order quantity	Article Number	EAN Code
FREEFLEX™ Work Pants black	44	1	1	4932498190	4058546520595
FREEFLEX™ Work Pants black	46	1	1	4932498191	4058546520601
FREEFLEX™ Work Pants black	48	1	1	4932498192	4058546520618
FREEFLEX™ Work Pants black	50	1	1	4932498193	4058546520625
FREEFLEX™ Work Pants black	52	1	1	4932498194	4058546520632
FREEFLEX™ Work Pants black	54	1	1	4932498195	4058546520649
FREEFLEX™ Work Pants black	56	1	1	4932498196	4058546520656
FREEFLEX™ Work Pants black	58	1	1	4932498197	4058546520663
FREEFLEX™ Work Pants black	60	1	1	4932498198	4058546520670
FREEFLEX™ Work Pants black	62	1	1	4932498199	4058546520687
FREEFLEX™ Work Pants black	64	1	1	4932498200	4058546520694

Knee Pad Inserts EVA

- Lightweight and comfortable foam padding.
- Ergonomically designed to ensure great flexibility in all movements, especially when kneeling.
- Easy insertion in knee pad pockets.
- Compatible with MILWAUKEE®FREEFLEX™Work pants.
- European Certified knee protectors: EN 14404 performance level 1.



Description	Pack quantity	Min. order quantity	Article Number	EAN Code
Knee Pad Inserts EVA	1	1	4932498789	4058546526580

NEW

WORKSKIN™ Cold Weather Base Layer Long Sleeve

- Custom sweat wicking fabric: fast sweat wicking performance while working.
- Brushed fleece interior: for added warmth and next-to-skin comfort on long cold days.
- Built to layer: fitted design and flat stitched seams prevent rubbing and layer easily.
- Trade built 4-way stretch and drop shoulder seams: allow for full freedom of movement.



Description	Size	Pack quantity	Min. order quantity	Article Number	EAN Code
WORKSKIN™Cold Weather Base Layer Long Sleeve Black	S	1	1	4932498283	4058546521523
WORKSKIN™Cold Weather Base Layer Long Sleeve Black	M	1	1	4932498284	4058546521530
WORKSKIN™Cold Weather Base Layer Long Sleeve Black	L	1	1	4932498285	4058546521547
WORKSKIN™Cold Weather Base Layer Long Sleeve Black	XL	1	1	4932498286	4058546521554
WORKSKIN™Cold Weather Base Layer Long Sleeve Black	XXL	1	1	4932498287	4058546521561
WORKSKIN™Cold Weather Base Layer Long Sleeve Black	XXXL	1	1	4932498288	4058546521578

WORKSKIN™ Cold Weather Base Layer Pants

- Custom sweat wicking fabric: fast sweat wicking performance while working.
- Brushed fleece interior: for added warmth and next-to-skin comfort on long cold days.
- Built to layer: fitted design and flat stitched seams prevent irritation and layer easily.
- Trade built 4-way stretch allows for full freedom of movement.



Description	Size	Pack quantity	Min. order quantity	Article Number	EAN Code
WORKSKIN™Cold Weather Base Layer Pants Black	S	1	1	4932498289	4058546521585
WORKSKIN™Cold Weather Base Layer Pants Black	M	1	1	4932498290	4058546521592
WORKSKIN™Cold Weather Base Layer Pants Black	L	1	1	4932498291	4058546521608
WORKSKIN™Cold Weather Base Layer Pants Black	XL	1	1	4932498292	4058546521615
WORKSKIN™Cold Weather Base Layer Pants Black	XXL	1	1	4932498293	4058546521622
WORKSKIN™Cold Weather Base Layer Pants Black	XXXL	1	1	4932498294	4058546521639

Baseball Cap Summary Table

- Lightweight cap to protect from the sun, on or off the jobsite.
- Flexible band for best fit. Cap sizes include S/M and L/XL available in red, black or grey.
- UV Protection Factor UPF 50+ according to EN 13758-1.

Description	Size	Pack quantity	Min. order quantity	Article Number	EAN Code
① Baseball cap - black	S / M	1	1	4932493095	4058546479664
Baseball cap - black	L / XL	1	1	4932493096	4058546479671
② Baseball cap - grey	S / M	1	1	4932493097	4058546479688
Baseball cap - grey	L / XL	1	1	4932493098	4058546479695
③ Baseball cap - red	S / M	1	1	4932493099	4058546479701
Baseball cap - red	L / XL	1	1	4932493100	4058546479718



Snapback Trucker cap black

- Lightweight cap to protect from the sun, on or off the jobsite.
- Ripstop polyester in the front panel provides added durability and a rugged look.
- Breathable mesh material for great ventilation.
- Snapback mechanism to fit all head sizes.

Description	Pack quantity	Min. order quantity	Article Number	EAN Code
Snapback Trucker cap - black	1	1	4932493107	4058546479787



Performance Cap Summary Table

- Lightweight cap to protect from the sun, on or off the jobsite.
- Stay cool, dry fast moisture wicking fabric.
- Flexible band for best fit. Cap sizes include S/M and L/XL available in grey, dark grey and blue.
- UV Protection Factor UPF 50+ according to EN 13758-1.

Description	Size	Pack quantity	Min. order quantity	Article Number	EAN Code
① Baseball cap performance - grey	S / M	1	1	4932493101	4058546479725
Baseball cap performance - grey	L / XL	1	1	4932493102	4058546479732
② Baseball cap performance - dark grey	S / M	1	1	4932493103	4058546479749
Baseball cap performance - dark grey	L / XL	1	1	4932493104	4058546479756
③ Baseball cap performance - blue	S / M	1	1	4932493105	4058546479763
Baseball cap performance - blue	L / XL	1	1	4932493106	4058546479770



Cuffed Beanie

- The thick, double-layered knit traps heat to keep the head warm in cold conditions.
- Made from soft 100% Acrylic material that feels comfortable against the skin without itching.
- The flexible knit design provides a secure fit that adapts to different head sizes while maintaining its shape.

Description	Size	Pack quantity	Min. order quantity	Article Number	EAN Code
① Cuffed Beanie - Black	One size fits most	1	1	4932499381	4058546565459
② Cuffed Beanie - Brown	One size fits most	1	1	4932499384	4058546565480
③ Cuffed Beanie - Dark Grey	One size fits most	1	1	4932499383	4058546565473
④ Cuffed Beanie - Green	One size fits most	1	1	4932499382	4058546565466
⑤ Cuffed Beanie - Red	One size fits most	1	1	4932499385	4058546565497



Beanie

- Comfortable beanie protects from cold environments.
- Fleece lined for more comfort and protects from wind.
- Durable 98% Polyester, 2% Spandex construction resists snagging and manages moisture to help prevent sweating and overheating.

Description	Pack quantity	Min. order quantity	Article Number	EAN Code
① Beanie - black	1	1	4932493109	4058546479800
② Beanie - grey	1	1	4932493110	4058546479817
③ Beanie - red	1	1	4932493111	4058546479824



WORKSKIN™ Low-Profile Beanie

- The brushed fleece interior provides soft warmth while maintaining a lightweight feel, ideal for all-day comfort.
- The 360-degree stretch fabric ensures a snug, comfortable fit that stays in place throughout the day.
- Made from 100% Polyester, the fabric efficiently wicks away sweat and dries quickly to keep the head dry and comfortable.

Description	Colour	Size	Pack quantity	Min. order quantity	Article Number	EAN Code
WORKSKIN™ Low-Profile Beanie	Black	One size fits most	1	1	4932499427	4058546565916



Cooling PVA Towel

- Long lasting cooling effect up to 4 hours, prolonging productive work hours and mitigating heat related illnesses.
- Soak the towel in water and wring out excess water to activate cooling effect.
- Quick, 30 second activation time.
- When cooling effect expires, simply re-apply water to reactivate the cooling effect.
- Blocks out harmful UV rays.
- Highly comfortable material.
- Machine washable.
- UPF 50+ Certified: EN 13758-1.



Description	Pack quantity	Min. order quantity	Article Number	EAN Code
Cooling PVA Towel	1	1	4932498146	4058546513061

Cooling Microfiber Towel

- Long lasting cooling effect up to 4 hours, prolonging productive work hours and mitigating heat related illnesses.
- Soak the towel in water and wring out excess water to activate cooling effect.
- Quick, 30 second activation time.
- When cooling effect expires, simply re-apply water to reactivate the cooling effect.
- Blocks out harmful UV rays.
- Highly comfortable material with durable edge banding.
- Machine washable.
- UPF 50+ Certified: EN 13758-1.



Description	Pack quantity	Min. order quantity	Article Number	EAN Code
Cooling Microfiber Towel	1	1	4932498076	4058546512361

Cooling Skull Cap

- Long lasting cooling effect up to 4 hours, prolonging productive work hours and mitigating heat related illnesses.
- Soak the product in water and wring out excess water to activate cooling effect.
- Quick, 30 second activation time.
- When cooling effect expires, simply re-apply water to reactivate the cooling effect.
- Blocks out harmful UV rays.
- Highly comfortable material with 4-way-stretch to fit most head sizes.
- Machine washable.
- UPF 50+ Certified: EN 13758-1.



Description	Pack quantity	Min. order quantity	Article Number	EAN Code
Cooling Skull Cap	1	1	4932498077	4058546512378

WORKSKIN™ Mid-Weight Cold Weather Balaclava

- The brushed fleece interior provides soft insulation to keep the head, face, and neck warm in cold conditions.
- The 82% Polyester, 18% Spandex panel over the mouth and nose allows for easy breathing while wicking away moisture to keep the skin dry.
- Made from 100% Polyester, the shell dries quickly and fits securely with a stretchy design that accommodates most head sizes.



Description	Colour	Pack quantity	Min. order quantity	Article Number	EAN Code
WORKSKIN™ Mid-Weight Cold Weather Balaclava	<attrib	1	1	4932499386	4058546565503

Neck gaiter & face mask

- Multi-functional, wear it as a neck gaiter, face mask, headband, sweatband or headgear protection on the jobsite
- Moisture wicking fabric dries quickly, repels sweat & water, keeps users dry on the jobsite
- Breathable, comfortable fabric made from 86 % Polyester and 14 % Spandex
- 50+ UPF sun protection blocks 98 % of UV rays
- Shields from wind, dust and jobsite debris
- Turnback hem prevents the fabric from sliding down
- Washer and dryer safe
- One size fits most
- Available in colours grey and red



Description	Colour	Pack quantity	Min. order quantity	Article Number	EAN Code
Neck gaiter & face mask - Red	Red	1	1	4933478780	4058546360627
Neck gaiter & face mask - Grey	Grey	1	1	4933478766	4058546360481

WORKSKIN™ Performance Neck Gaiter Face Mask

- Multi-functional, wear it as a neck gaiter, face mask, headband, sweatband or headgear to protect from hot conditions, sun or wind.
- Breathable fabric to stay cool and dry fast while working in hot conditions.
- Adjustable neck gaiter has a rear drawstring to customize for more comfort.
- Blocks harmful UV rays. rated UPF 50+ according to EN 13758-1 (red version only)



Description	Pack quantity	Min. order quantity	Article Number	EAN Code
WORKSKIN™ Performance Neck Gaiter Face Mask grey	1	1	4932493093	4058546479640
WORKSKIN™ Performance Neck Gaiter Face Mask red	1	1	4932493094	4058546479657

Performance Face Covering

- Structured Fit Design - Separates mask from mouth.
- 3 Soft and Breathable Layers - all day comfort for long time wear.
- Comfortable Adjustable Ear Loops - No pressure on the ears.
- Water Repellent Outer Layer.
- Flexible Nose Bridge - Adjustability for a better sealing and to reduce fog on glasses.
- Moisture Wicking Inner Layer - Stay Cool, Dry Fast.
- Machine Washable.



Description	Size	Pack quantity	Min. order quantity	Article number	EAN Code
Performance Face Covering S/M - 3pcs	S / M	3	1	4932478865	4058546361471
Performance Face Covering L/XL - 3pcs	L / XL	3	1	4932478866	4058546361488

Flexible knee pad

- Flexible, lightweight and comfortable foam padding.
- Water resistant cap.
- Debris guard to prevent debris from entering.
- Size adjustable straps for a custom fit.
- Buckles to quickly put on and off the knee pad.
- European Certified knee protectors: EN 14404 performance level 1.



Description	Pack quantity	Min. order quantity	Article Number	EAN Code
Flexible knee pad - 1 pair	1	1	4932478136	4058546340698

Hard knee pad

- Thick comfortable foam padding with a supporting gel zone.
- Durable hard cap which withstands rough surfaces.
- Size adjustable double straps for a better hold and a custom fit.
- Buckles with metal rivets that withstand repeated fastenings.
- 1680D Ballistic Nylon for a long lifetime.
- European Certified knee protectors: EN 14404 performance level 2.



Description	Pack quantity	Min. order quantity	Article Number	EAN Code
Hard knee pad - 1 pair	1	1	4932478137	4058546340704

Premium non-marking knee pad

- High density foam padding with a supporting premium gel injection.
- Non-marking coating to prevent scratches on sensitive surfaces.
- Comfortable and size adjustable double straps with a wider lower strap.
- Buckles with metal rivets that withstand repeated fastenings.
- 1680D Ballistic Nylon for a long lifetime.
- European Certified knee protectors: EN 14404 performance level 1.



Description	Pack quantity	Min. order quantity	Article Number	EAN Code
Premium non-marking knee pad - 1 pair	1	1	4932478139	4058546340728

Milwaukee
SAFETY FOOTWEAR

**ENERGY
FOAM**

**ENERGY
FOAM**

Expanded TPU provides maximum energy return and comfort

**ANTI-
PUNCTURE
PLATE**

Sits underneath ENERGY FOAM technology



**VIEW THE MILWAUKEE®
SAFETY FOOTWEAR RANGE**



**TYPICAL
JOBSITE
SAFETY
FOOTWEAR**

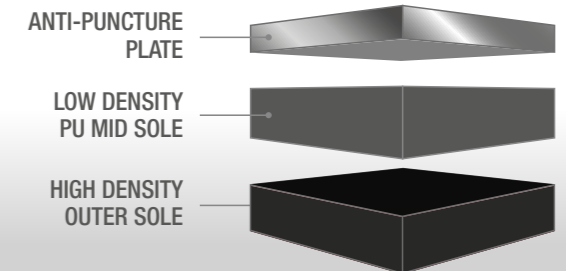

MILWAUKEE® ENERGY FOAM provides unmatched comfort in every step. With its unique construction, the premium expanded TPU foam sits above the anti-puncture plate allowing users to be in direct contact with the cushioning technology. Ensuring maximum energy return and comfort for all day use on the jobsite.

MILWAUKEE® SAFETY SHOES

TYPE



SHOE MODEL		MILWAUKEE® FLEXTRED™								
SHOE TYPE		Safety Trainer	Safety Trainer	Safety Boot	Safety Boot	Safety Trainer	Safety Trainer	Safety Boot	Safety Trainer	Safety Boot
LACING TYPE		Laces	BOA®	Laces	BOA®	Laces	BOA®	Laces	BOA®	Laces
COLOUR		Black	Black	Black	Black	Black	Black	Black	Black	Beige
UPPER MATERIAL		Textile	Textile	Textile	Textile	Nubuck Leather	Nubuck Leather	Nubuck Leather	Nubuck Leather	Nubuck Leather
SHOE SIZE		36-48	36-48	36-48	36-48	36-48	36-48	36-48	36-48	36-48
METAL FREE (EXCEPT BOA) / SUITABLE FOR SECURITY GATES		yes	yes	yes	yes	yes	yes	yes	yes	yes
SAFETY SHOE CLASS										
SAFETY SHOE CLASS		S1PS	S1PS	S1PS	S1PS	S3S	S3S	S3S	S3S	S3S
TOE CAP (MATERIAL)		Fiberglass	Fiberglass	Fiberglass	Fiberglass	Fiberglass	Fiberglass	Fiberglass	Fiberglass	Fiberglass
MANDATORY SLIP RESISTANCE (FORMERLY SRA)		✓	✓	✓	✓	✓	✓	✓	✓	✓
CLOSED HEEL		✓	✓	✓	✓	✓	✓	✓	✓	✓
A - ELECTROSTATIC DISCHARGE		✓	✓	✓	✓	✓	✓	✓	✓	✓
B - ENERGY ABSORBING UNDER THE HEEL			✓	✓	✓	✓	✓	✓	✓	✓
PUNCTURE PROTECTION / ANTIPUNCTURE PLATE	P - Metal	-	-	-	-	-	-	-	-	-
	PL - Non-Metal - (4.5 mm Test Nail)	-	-	-	-	-	-	-	-	-
	PS - Non-Metal - (3 mm Test Nail)	✓	✓	✓	✓	✓	✓	✓	✓	✓
WPA - WATER PENETRATION & ABSORPTION		-	-	-	-	✓	✓	✓	✓	✓
WR - WATER RESISTANCE (MEMBRANE)		-	-	-	-	-	-	-	-	-
ADDITIONAL REQUIREMENTS										
FO	Oil and Gasoline Resistance of the Outsole	✓	✓	✓	✓	✓	✓	✓	✓	✓
HI	HI - Heat Insulation of the Shoe Base	-	-	-	-	-	-	-	-	-
CI	Cold Insulation of the Shoe	-	-	-	-	-	-	-	-	-
HRO	Short-term Heat Resistance of the Outsole Material up to 300°C	-	-	-	-	-	-	-	-	-
M	Metatarsal Protection	-	-	-	-	-	-	-	-	-
AN	Ankle Protection	-	-	-	-	-	-	-	-	-
SC	Abrasion Resistance of the Toe Cap Material	-	-	-	-	✓	✓	✓	✓	-
SR	Slip Resistance, tested on a ceramic tile with glycerin	✓	✓	✓	✓	✓	✓	✓	✓	✓
LG	Grip on Ladders through Transverse Inserted Profile (at least 1.5 mm high)	-	-	-	-	-	-	-	-	-
CR	Cut Resistance in the Area above the Sole Edge	-	-	-	-	-	-	-	-	-
ESD	Anti-Static	✓	✓	✓	✓	✓	✓	✓	✓	✓

MILWAUKEE® ARMOURTRED™						
SHOE TYPE		Safety Trainer	Safety Boot	High Safety Boot	Safety Trainer	Safety Boot
LACING TYPE		Laces	Laces	Laces	BOA®	BOA®
COLOUR		Black	Black	Black	Black	Black
UPPER MATERIAL		Leather	Leather	Microfiber	Microfiber	Microfiber
SHOE SIZE		39-48	39-48	39-48	39-48	39-48
METAL FREE (EXCEPT BOA) / SUITABLE FOR SECURITY GATES		no	no	no	no	no
SAFETY SHOE CLASS						
SAFETY SHOE CLASS		S3S	S3S	S7S	S3S	S7S
TOE CAP (MATERIAL)		Aluminium	Aluminium	Aluminium	Aluminium	Aluminium
MANDATORY SLIP RESISTANCE (FORMERLY SRA)		✓	✓	✓	✓	✓
CLOSED HEEL		✓	✓	✓	✓	✓
A - ELECTROSTATIC DISCHARGE		✓	✓	✓	✓	✓
B - ENERGY ABSORBING UNDER THE HEEL		✓	✓	✓	✓	✓
PUNCTURE PROTECTION / ANTIPUNCTURE PLATE	P - Metal	-	-	-	-	-
	PL - Non-Metal - (4.5 mm Test Nail)	-	-	-	-	-
	PS - Non-Metal - (3 mm Test Nail)	✓	✓	✓	✓	✓
WPA - WATER PENETRATION & ABSORPTION		✓	✓	✓	✓	✓
WR - WATER RESISTANCE (MEMBRANE)		-	-	Sympatex® Membrane	-	Sympatex® Membrane
ADDITIONAL REQUIREMENTS						
FO	Oil and Gasoline Resistance of the Outsole	✓	✓	✓	✓	✓
HI	HI - Heat Insulation of the Shoe Base	-	-	-	-	-
CI	Cold Insulation of the Shoe	-	-	-	-	-
HRO	Short-term Heat Resistance of the Outsole Material up to 300°C	✓	✓	✓	✓	✓
M	Metatarsal Protection	-	-	-	-	-
AN	Ankle Protection	-	-	✓	-	-
SC	Abrasion Resistance of the Toe Cap Material	✓	✓	✓	✓	✓
SR	Slip Resistance, tested on a ceramic tile with glycerin	✓	✓	✓	✓	✓
LG	Grip on Ladders through Transverse Inserted Profile (at least 1.5 mm high)	✓	✓	✓	✓	✓
CR	Cut Resistance in the Area above the Sole Edge	-	-	-	-	-
ESD	Anti-Static	✓	✓	-	✓	-

PERSONAL PROTECTIVE EQUIPMENT



**ROLLCAGE™
HEEL STABILIZER**



**REFLECTIVE
HEEL LOOP**

**LACE
POCKET**



**STEP
RELEASE™**

**ENERGY
FOAM
SITS ABOVE ANTI-
PUNCTURE PLATE
FOR MAXIMUM
COMFORT**

**LIGHTWEIGHT
COMPOSITE
TOE CAP**



**VIEW THE MILWAUKEE®
FLEXTRED™ RANGE**



**Flextred™ S1PS Safety Trainers black
1L110133 ESD FO SR**

- Flexible and lightweight all-round safety trainers for tradesmen protection.
- ENERGY FOAM heel cushioning construction for superior energy return and maximum comfort.
- STEP-RELEASE™ heel for a convenient and rapid shoe removal.
- ROLLCAGE™ heel stabilizer for great stability even in demanding terrain.
- Lace pocket for storing shoelaces to prevent unintentional opening, tripping hazards and lace damage.
- Textile upper for all-day ventilation and breathability.
- Reinforced front to protect toe cap from abrasion.
- Metal free construction to conveniently pass through security gates.
- Superior grip to prevent slipping.
- ESD (electrostatic discharge) certified.
- Certified according to EN ISO 20345:2022 S1PS ESD FO SR.



Description	Pack quantity	Min. order quantity	Article Number	EAN Code
Flextred™ S1PS Safety Trainers black 1L110133 ESD FO SR 36	1	1	4932493688	4058546508487
Flextred™ S1PS Safety Trainers black 1L110133 ESD FO SR 37	1	1	4932493689	4058546508494
Flextred™ S1PS Safety Trainers black 1L110133 ESD FO SR 38	1	1	4932493690	4058546508500
Flextred™ S1PS Safety Trainers black 1L110133 ESD FO SR 39	1	1	4932493691	4058546508517
Flextred™ S1PS Safety Trainers black 1L110133 ESD FO SR 40	1	1	4932493692	4058546508524
Flextred™ S1PS Safety Trainers black 1L110133 ESD FO SR 41	1	1	4932493693	4058546508531
Flextred™ S1PS Safety Trainers black 1L110133 ESD FO SR 42	1	1	4932493694	4058546508548
Flextred™ S1PS Safety Trainers black 1L110133 ESD FO SR 43	1	1	4932493695	4058546508555
Flextred™ S1PS Safety Trainers black 1L110133 ESD FO SR 44	1	1	4932493696	4058546508562
Flextred™ S1PS Safety Trainers black 1L110133 ESD FO SR 45	1	1	4932493697	4058546508579
Flextred™ S1PS Safety Trainers black 1L110133 ESD FO SR 46	1	1	4932493698	4058546508586
Flextred™ S1PS Safety Trainers black 1L110133 ESD FO SR 47	1	1	4932493699	4058546508593
Flextred™ S1PS Safety Trainers black 1L110133 ESD FO SR 48	1	1	4932493700	4058546508609

**Flextred™ S1PS Safety Trainers black
B1L110133 ESD FO SR**

- Flexible and lightweight all-round safety trainers for tradesmen protection.
- ENERGY FOAM heel cushioning construction for superior energy return and maximum comfort.
- STEP-RELEASE™ heel for a convenient and rapid shoe removal.
- ROLLCAGE™ heel stabilizer for great stability even in demanding terrain.
- BOA® Fit system. Strong and reliable speedlacing system for a perfect fit and a fast and effortless use even with gloves.
- Textile upper for all-day ventilation and breathability.
- Reinforced front to protect toe cap from abrasion.
- Metal free construction, except BOA® Fit System which still allows users to conveniently pass through security gates.
- Superior grip to prevent slipping.
- ESD (electrostatic discharge) certified.



Description	Pack quantity	Min. order quantity	Article Number	EAN Code
Flextred™ S1PS Safety Trainers black B1L110133 ESD FO SR 36	1	1	4932498080	4058546512408
Flextred™ S1PS Safety Trainers black B1L110133 ESD FO SR 37	1	1	4932498081	4058546512415
Flextred™ S1PS Safety Trainers black B1L110133 ESD FO SR 38	1	1	4932498082	4058546512422
Flextred™ S1PS Safety Trainers black B1L110133 ESD FO SR 39	1	1	4932498083	4058546512439
Flextred™ S1PS Safety Trainers black B1L110133 ESD FO SR 40	1	1	4932498084	4058546512446
Flextred™ S1PS Safety Trainers black B1L110133 ESD FO SR 41	1	1	4932498085	4058546512453
Flextred™ S1PS Safety Trainers black B1L110133 ESD FO SR 42	1	1	4932498086	4058546512460
Flextred™ S1PS Safety Trainers black B1L110133 ESD FO SR 43	1	1	4932498087	4058546512477
Flextred™ S1PS Safety Trainers black B1L110133 ESD FO SR 44	1	1	4932498088	4058546512484
Flextred™ S1PS Safety Trainers black B1L110133 ESD FO SR 45	1	1	4932498089	4058546512491
Flextred™ S1PS Safety Trainers black B1L110133 ESD FO SR 46	1	1	4932498090	4058546512507
Flextred™ S1PS Safety Trainers black B1L110133 ESD FO SR 47	1	1	4932498091	4058546512514
Flextred™ S1PS Safety Trainers black B1L110133 ESD FO SR 48	1	1	4932498092	4058546512521

Flexfred™ S1PS Safety Boots black 1M110133 ESD FO SR

- Flexible and lightweight all-round safety boots for tradesmen protection.
- ENERGY FOAM heel cushioning construction for superior energy return and maximum comfort.
- STEP-RELEASE™ heel for a convenient and rapid shoe removal.
- ROLLCAGE™ heel stabilizer for great stability even in demanding terrain.
- Lace pocket for storing shoelaces to prevent unintentional opening, tripping hazards and lace damage.
- Textile upper for all-day ventilation and breathability.
- Reinforced front to protect toe cap from abrasion.
- Metal free construction to conveniently pass through security gates.
- Superior grip to prevent slipping.
- ESD (electrostatic discharge) certified.
- Certified according to EN ISO 20345:2022 S1PS ESD FO SR.



Description	Pack quantity	Min. order quantity	Article Number	EAN Code
Flexfred™ S1PS Safety Boots black 1M110133 ESD FO SR 36	1	1	4932493701	4058546508616
Flexfred™ S1PS Safety Boots black 1M110133 ESD FO SR 37	1	1	4932493702	4058546508623
Flexfred™ S1PS Safety Boots black 1M110133 ESD FO SR 38	1	1	4932493703	4058546508630
Flexfred™ S1PS Safety Boots black 1M110133 ESD FO SR 39	1	1	4932493704	4058546508647
Flexfred™ S1PS Safety Boots black 1M110133 ESD FO SR 40	1	1	4932493705	4058546508654
Flexfred™ S1PS Safety Boots black 1M110133 ESD FO SR 41	1	1	4932493706	4058546508661
Flexfred™ S1PS Safety Boots black 1M110133 ESD FO SR 42	1	1	4932493707	4058546508678
Flexfred™ S1PS Safety Boots black 1M110133 ESD FO SR 43	1	1	4932493708	4058546508685
Flexfred™ S1PS Safety Boots black 1M110133 ESD FO SR 44	1	1	4932493709	4058546508692
Flexfred™ S1PS Safety Boots black 1M110133 ESD FO SR 45	1	1	4932493710	4058546508708
Flexfred™ S1PS Safety Boots black 1M110133 ESD FO SR 46	1	1	4932493711	4058546508715
Flexfred™ S1PS Safety Boots black 1M110133 ESD FO SR 47	1	1	4932493712	4058546508722
Flexfred™ S1PS Safety Boots black 1M110133 ESD FO SR 48	1	1	4932493713	4058546508739

Flexfred™ S1PS Safety Boots black B1M110133 ESD FO SR

- Flexible and lightweight all-round safety boots for tradesmen protection.
- ENERGY FOAM heel cushioning construction for superior energy return and maximum comfort.
- STEP-RELEASE™ heel for a convenient and rapid shoe removal.
- ROLLCAGE™ heel stabilizer for great stability even in demanding terrain.
- BOA® Fit System delivers micro adjustable precision fit, engineered to perform in the toughest conditions.
- Textile upper for all-day ventilation and breathability.
- Reinforced front to protect toe cap from abrasion.
- Metal free construction, except BOA® Fit System which still allows users to conveniently pass through security gates.
- Superior grip to prevent slipping.
- ESD (electrostatic discharge) certified.



Description	Pack quantity	Min. order quantity	Article Number	EAN Code
Flexfred™ S1PS Safety Boots black B1M110133 ESD FO SR 36	1	1	4932498093	4058546512538
Flexfred™ S1PS Safety Boots black B1M110133 ESD FO SR 37	1	1	4932498094	4058546512545
Flexfred™ S1PS Safety Boots black B1M110133 ESD FO SR 38	1	1	4932498095	4058546512552
Flexfred™ S1PS Safety Boots black B1M110133 ESD FO SR 39	1	1	4932498096	4058546512569
Flexfred™ S1PS Safety Boots black B1M110133 ESD FO SR 40	1	1	4932498097	4058546512576
Flexfred™ S1PS Safety Boots black B1M110133 ESD FO SR 41	1	1	4932498098	4058546512583
Flexfred™ S1PS Safety Boots black B1M110133 ESD FO SR 42	1	1	4932498099	4058546512590
Flexfred™ S1PS Safety Boots black B1M110133 ESD FO SR 43	1	1	4932498100	4058546512606
Flexfred™ S1PS Safety Boots black B1M110133 ESD FO SR 44	1	1	4932498101	4058546512613
Flexfred™ S1PS Safety Boots black B1M110133 ESD FO SR 45	1	1	4932498102	4058546512620
Flexfred™ S1PS Safety Boots black B1M110133 ESD FO SR 46	1	1	4932498103	4058546512637
Flexfred™ S1PS Safety Boots black B1M110133 ESD FO SR 47	1	1	4932498104	4058546512644
Flexfred™ S1PS Safety Boots black B1M110133 ESD FO SR 48	1	1	4932498105	4058546512651

Flexfred™ S3S Safety Trainers black 1L110133 ESD SC FO SR

- Flexible and lightweight all-round safety trainers for tradesmen protection.
- ENERGY FOAM heel cushioning construction for superior energy return and maximum comfort.
- STEP-RELEASE™ heel for a convenient and rapid shoe removal.
- ROLLCAGE™ heel stabilizer for great stability even in demanding terrain.
- Lace pocket for storing shoelaces to prevent unintentional opening, tripping hazards and lace damage.
- Nubuck water repellent leather upper to protect from water, dust and dirt.
- Scuff cap for increased toe cap protection and durability.
- Metal free construction to conveniently pass through security gates.
- Superior grip to prevent slipping.
- ESD (electrostatic discharge) certified.
- Certified according to EN ISO 20345:2022 S3S ESD SC FO SR.



Description	Pack quantity	Min. order quantity	Article Number	EAN Code
Flexfred™ S3S Safety Trainers black 1L110133 ESD SC FO SR 36	1	1	4932493714	4058546508746
Flexfred™ S3S Safety Trainers black 1L110133 ESD SC FO SR 37	1	1	4932493715	4058546508753
Flexfred™ S3S Safety Trainers black 1L110133 ESD SC FO SR 38	1	1	4932493716	4058546508760
Flexfred™ S3S Safety Trainers black 1L110133 ESD SC FO SR 39	1	1	4932493717	4058546508777
Flexfred™ S3S Safety Trainers black 1L110133 ESD SC FO SR 40	1	1	4932493718	4058546508784
Flexfred™ S3S Safety Trainers black 1L110133 ESD SC FO SR 41	1	1	4932493719	4058546508791
Flexfred™ S3S Safety Trainers black 1L110133 ESD SC FO SR 42	1	1	4932493720	4058546508807
Flexfred™ S3S Safety Trainers black 1L110133 ESD SC FO SR 43	1	1	4932493721	4058546508814
Flexfred™ S3S Safety Trainers black 1L110133 ESD SC FO SR 44	1	1	4932493722	4058546508821
Flexfred™ S3S Safety Trainers black 1L110133 ESD SC FO SR 45	1	1	4932493723	4058546508838
Flexfred™ S3S Safety Trainers black 1L110133 ESD SC FO SR 46	1	1	4932493724	4058546508845
Flexfred™ S3S Safety Trainers black 1L110133 ESD SC FO SR 47	1	1	4932493725	4058546508852
Flexfred™ S3S Safety Trainers black 1L110133 ESD SC FO SR 48	1	1	4932493726	4058546508869

Flexfred™ S3S Safety Trainers black B1L110133 ESD SC FO SR

- Flexible and lightweight all-round safety trainers for tradesmen protection.
- ENERGY FOAM heel cushioning construction for superior energy return and maximum comfort.
- STEP-RELEASE™ heel for a convenient and rapid shoe removal.
- ROLLCAGE™ heel stabilizer for great stability even in demanding terrain.
- BOA® Fit system. Strong and reliable speedlacing system for a perfect fit and a fast and effortless use even with gloves.
- Nubuck water repellent leather upper to protect from water, dust and dirt.
- Scuff cap for increased toe cap protection and durability.
- Metal free construction, except BOA® Fit System which still allows users to conveniently pass through security gates.
- Superior grip to prevent slipping.
- ESD (electrostatic discharge) certified.



Description	Pack quantity	Min. order quantity	Article Number	EAN Code
Flexfred™ S3S Safety Trainers black B1L110133 ESD SC FO SR 36	1	1	4932498106	4058546512668
Flexfred™ S3S Safety Trainers black B1L110133 ESD SC FO SR 37	1	1	4932498107	4058546512675
Flexfred™ S3S Safety Trainers black B1L110133 ESD SC FO SR 38	1	1	4932498108	4058546512682
Flexfred™ S3S Safety Trainers black B1L110133 ESD SC FO SR 39	1	1	4932498109	4058546512699
Flexfred™ S3S Safety Trainers black B1L110133 ESD SC FO SR 40	1	1	4932498110	4058546512705
Flexfred™ S3S Safety Trainers black B1L110133 ESD SC FO SR 41	1	1	4932498111	4058546512712
Flexfred™ S3S Safety Trainers black B1L110133 ESD SC FO SR 42	1	1	4932498112	4058546512729
Flexfred™ S3S Safety Trainers black B1L110133 ESD SC FO SR 43	1	1	4932498113	4058546512736
Flexfred™ S3S Safety Trainers black B1L110133 ESD SC FO SR 44	1	1	4932498114	4058546512743
Flexfred™ S3S Safety Trainers black B1L110133 ESD SC FO SR 45	1	1	4932498115	4058546512750
Flexfred™ S3S Safety Trainers black B1L110133 ESD SC FO SR 46	1	1	4932498116	4058546512767
Flexfred™ S3S Safety Trainers black B1L110133 ESD SC FO SR 47	1	1	4932498117	4058546512774
Flexfred™ S3S Safety Trainers black B1L110133 ESD SC FO SR 48	1	1	4932498118	4058546512781

Flexfred™ S3S Safety Boots black 1M110133 ESD SC FO SR

- Flexible and lightweight all-round safety boots for tradesmen protection.
- ENERGY FOAM heel cushioning construction for superior energy return and maximum comfort.
- STEP-RELEASE™ heel for a convenient and rapid shoe removal.
- ROLLCAGE™ heel stabilizer for great stability even in demanding terrain.
- Lace pocket for storing shoelaces to prevent unintentional opening, tripping hazards and lace damage.
- Nubuck water repellent leather upper to protect from water, dust and dirt.
- Scuff cap for increased toe cap protection and durability.
- Metal free construction to conveniently pass through security gates.
- Superior grip to prevent slipping.
- ESD (electrostatic discharge) certified.
- Certified according to EN ISO 20345:2022 S3S ESD SC FO SR.



Description	Pack quantity	Min. order quantity	Article Number	EAN Code
Flexfred™ S3S Safety Boots black 1M110133 ESD SC FO SR 36	1	1	4932493727	4058546508876
Flexfred™ S3S Safety Boots black 1M110133 ESD SC FO SR 37	1	1	4932493728	4058546508883
Flexfred™ S3S Safety Boots black 1M110133 ESD SC FO SR 38	1	1	4932493729	4058546508890
Flexfred™ S3S Safety Boots black 1M110133 ESD SC FO SR 39	1	1	4932493730	4058546508906
Flexfred™ S3S Safety Boots black 1M110133 ESD SC FO SR 40	1	1	4932493731	4058546508913
Flexfred™ S3S Safety Boots black 1M110133 ESD SC FO SR 41	1	1	4932493732	4058546508920
Flexfred™ S3S Safety Boots black 1M110133 ESD SC FO SR 42	1	1	4932493733	4058546508937
Flexfred™ S3S Safety Boots black 1M110133 ESD SC FO SR 43	1	1	4932493734	4058546508944
Flexfred™ S3S Safety Boots black 1M110133 ESD SC FO SR 44	1	1	4932493735	4058546508951
Flexfred™ S3S Safety Boots black 1M110133 ESD SC FO SR 45	1	1	4932493736	4058546508968
Flexfred™ S3S Safety Boots black 1M110133 ESD SC FO SR 46	1	1	4932493737	4058546508975
Flexfred™ S3S Safety Boots black 1M110133 ESD SC FO SR 47	1	1	4932493738	4058546508982
Flexfred™ S3S Safety Boots black 1M110133 ESD SC FO SR 48	1	1	4932493739	4058546508999

Flexfred™ S3S Safety Boots black B1M110133 ESD SC FO SR

- Flexible and lightweight all-round safety boots for tradesmen protection.
- ENERGY FOAM heel cushioning construction for superior energy return and maximum comfort.
- STEP-RELEASE™ heel for a convenient and rapid shoe removal.
- ROLLCAGE™ heel stabilizer for great stability even in demanding terrain.
- BOA® Fit system. Strong and reliable speedlacing system for a perfect fit and a fast and effortless use even with gloves.
- Nubuck water repellent leather upper to protect from water, dust and dirt.
- Scuff cap for increased toe cap protection and durability.
- Metal free construction, except BOA® Fit System which still allows users to conveniently pass through security gates.
- Superior grip to prevent slipping.
- ESD (electrostatic discharge) certified.



Description	Pack quantity	Min. order quantity	Article Number	EAN Code
Flexfred™ S3S Safety Boots black B1M110133 ESD SC FO SR 36	1	1	4932498119	4058546512798
Flexfred™ S3S Safety Boots black B1M110133 ESD SC FO SR 37	1	1	4932498120	4058546512804
Flexfred™ S3S Safety Boots black B1M110133 ESD SC FO SR 38	1	1	4932498121	4058546512811
Flexfred™ S3S Safety Boots black B1M110133 ESD SC FO SR 39	1	1	4932498122	4058546512828
Flexfred™ S3S Safety Boots black B1M110133 ESD SC FO SR 40	1	1	4932498123	4058546512835
Flexfred™ S3S Safety Boots black B1M110133 ESD SC FO SR 41	1	1	4932498124	4058546512842
Flexfred™ S3S Safety Boots black B1M110133 ESD SC FO SR 42	1	1	4932498125	4058546512859
Flexfred™ S3S Safety Boots black B1M110133 ESD SC FO SR 43	1	1	4932498126	4058546512866
Flexfred™ S3S Safety Boots black B1M110133 ESD SC FO SR 44	1	1	4932498127	4058546512873
Flexfred™ S3S Safety Boots black B1M110133 ESD SC FO SR 45	1	1	4932498128	4058546512880
Flexfred™ S3S Safety Boots black B1M110133 ESD SC FO SR 46	1	1	4932498129	4058546512897
Flexfred™ S3S Safety Boots black B1M110133 ESD SC FO SR 47	1	1	4932498130	4058546512903
Flexfred™ S3S Safety Boots black B1M110133 ESD SC FO SR 48	1	1	4932498131	4058546512910

Flexfred™ S3S Safety Boots beige 1M171311 ESD FO SR

- Flexible and lightweight all-round safety boots for tradesmen protection.
- ENERGY FOAM heel cushioning construction for superior energy return and maximum comfort.
- STEP-RELEASE™ heel for a convenient and rapid shoe removal.
- ROLLCAGE™ heel stabilizer for great stability even in demanding terrain.
- Lace pocket for storing shoelaces to prevent unintentional opening, tripping hazards and lace damage.
- Nubuck water repellent leather upper to protect from water, dust and dirt.
- Metal free construction to conveniently pass through security gates.
- Superior grip to prevent slipping.
- ESD (electrostatic discharge) certified.
- Certified according to EN ISO 20345:2022 S3S ESD FO SR.



Description	Pack quantity	Min. order quantity	Article Number	EAN Code
Flexfred™ S3S Safety Boots beige 1M171311 ESD FO SR 36	1	1	4932493740	4058546509002
Flexfred™ S3S Safety Boots beige 1M171311 ESD FO SR 37	1	1	4932493741	4058546509019
Flexfred™ S3S Safety Boots beige 1M171311 ESD FO SR 38	1	1	4932493742	4058546509026
Flexfred™ S3S Safety Boots beige 1M171311 ESD FO SR 39	1	1	4932493743	4058546509033
Flexfred™ S3S Safety Boots beige 1M171311 ESD FO SR 40	1	1	4932493744	4058546509040
Flexfred™ S3S Safety Boots beige 1M171311 ESD FO SR 41	1	1	4932493745	4058546509057
Flexfred™ S3S Safety Boots beige 1M171311 ESD FO SR 42	1	1	4932493746	4058546509064
Flexfred™ S3S Safety Boots beige 1M171311 ESD FO SR 43	1	1	4932493747	4058546509071
Flexfred™ S3S Safety Boots beige 1M171311 ESD FO SR 44	1	1	4932493748	4058546509088
Flexfred™ S3S Safety Boots beige 1M171311 ESD FO SR 45	1	1	4932493749	4058546509095
Flexfred™ S3S Safety Boots beige 1M171311 ESD FO SR 46	1	1	4932493750	4058546509101
Flexfred™ S3S Safety Boots beige 1M171311 ESD FO SR 47	1	1	4932493751	4058546509118
Flexfred™ S3S Safety Boots beige 1M171311 ESD FO SR 48	1	1	4932493752	4058546509125





**HEAVY DUTY
ALUMINIUM
TOE CAP**



**REFLECTIVE
HEEL LOOP**

**LACE
POCKET**

**SHOCK
SHIELD**



**STEP
RELEASE™**

**ENERGY
FOAM
SITS ABOVE ANTI-
PUNCTURE PLATE
FOR MAXIMUM
COMFORT**

**ROLLCAGE™
HEEL STABILIZER**



**VIEW THE MILWAUKEE®
ARMOURTRED™ RANGE**

**Armourtred™ S3S Safety Trainers black
1L110111W ESD CI HI HRO SC FO LG SR**

NEW

- Durable and protective safety trainers for heavy duty jobsite protection.
- ENERGY FOAM heel cushioning system for superior energy return and maximum comfort.
- STEP-RELEASE™ heel for a convenient and rapid shoe removal.
- ROLLCAGE™ heel stabilizer for great stability even in demanding terrain.
- SHOCKSHIELD front hammer for added protection and rubber reinforced outsole with strong studs for best grip in demanding terrain.
- Lace pocket for storing shoelaces to prevent unintentional opening, tripping hazards and lace damage.
- Full grain cow leather upper to protect from water, dust and dirt and is easy to clean.
- Ladder grip sole area to climb up ladders safely.
- Scuff cap for increased toe cap protection and durability.
- Superior grip to prevent from slips.
- Heat Resistant outsole to 300°C.
- ESD (electrostatic discharge) certified.
- Certified according to EN ISO 20345:2022 S3S ESD CI HI HRO SC FO LG SR .



Description	Pack quantity	Min. order quantity	Article Number	EAN Code
Armourtred™ S3S Safety Trainers black 1L110111W ESD CI HI HRO SC FO LG SR 39	1	1	4932493753	4058546509132
Armourtred™ S3S Safety Trainers black 1L110111W ESD CI HI HRO SC FO LG SR 40	1	1	4932493754	4058546509149
Armourtred™ S3S Safety Trainers black 1L110111W ESD CI HI HRO SC FO LG SR 41	1	1	4932493755	4058546509156
Armourtred™ S3S Safety Trainers black 1L110111W ESD CI HI HRO SC FO LG SR 42	1	1	4932493756	4058546509163
Armourtred™ S3S Safety Trainers black 1L110111W ESD CI HI HRO SC FO LG SR 43	1	1	4932493757	4058546509170
Armourtred™ S3S Safety Trainers black 1L110111W ESD CI HI HRO SC FO LG SR 44	1	1	4932493758	4058546509187
Armourtred™ S3S Safety Trainers black 1L110111W ESD CI HI HRO SC FO LG SR 45	1	1	4932493759	4058546509194
Armourtred™ S3S Safety Trainers black 1L110111W ESD CI HI HRO SC FO LG SR 46	1	1	4932493760	4058546509200
Armourtred™ S3S Safety Trainers black 1L110111W ESD CI HI HRO SC FO LG SR 47	1	1	4932493761	4058546509217
Armourtred™ S3S Safety Trainers black 1L110111W ESD CI HI HRO SC FO LG SR 48	1	1	4932493762	4058546509224

**Armourtred™ S3S Safety Trainers black
B1L110111W ESD CI HI HRO SC FO LG SR**

NEW

- Durable and protective safety trainers for heavy duty jobsite protection.
- ENERGY FOAM heel cushioning system for superior energy return and maximum comfort.
- STEP-RELEASE™ heel for a convenient and rapid shoe removal.
- ROLLCAGE™ heel stabilizer for great stability even in demanding terrain.
- SHOCKSHIELD front hammer for added protection and rubber reinforced outsole with strong studs for best grip in demanding terrain.
- BOA® Fit System delivers micro adjustable precision fit, engineered to perform in the toughest conditions.
- Microfiber light weight upper to protect from water, dust and dirt and is easy to clean.
- Ladder grip sole area to climb up ladders safely.
- Scuff cap for increased toe cap protection and durability.
- Heat Resistant outsole to 300°C.
- ESD (electrostatic discharge) certified.
- Certified according to EN ISO 20345:2022 S3S ESD CI HI HRO SC FO LG SR.



Description	Pack quantity	Min. order quantity	Article Number	EAN Code
Armourtred™ S3S Safety Trainers black B1L110111W ESD CI HI HRO SC FO LG SR 39	1	1	4932493783	4058546509439
Armourtred™ S3S Safety Trainers black B1L110111W ESD CI HI HRO SC FO LG SR 40	1	1	4932493784	4058546509446
Armourtred™ S3S Safety Trainers black B1L110111W ESD CI HI HRO SC FO LG SR 41	1	1	4932493785	4058546509453
Armourtred™ S3S Safety Trainers black B1L110111W ESD CI HI HRO SC FO LG SR 42	1	1	4932493786	4058546509460
Armourtred™ S3S Safety Trainers black B1L110111W ESD CI HI HRO SC FO LG SR 43	1	1	4932493787	4058546509477
Armourtred™ S3S Safety Trainers black B1L110111W ESD CI HI HRO SC FO LG SR 44	1	1	4932493788	4058546509484
Armourtred™ S3S Safety Trainers black B1L110111W ESD CI HI HRO SC FO LG SR 45	1	1	4932493789	4058546509491
Armourtred™ S3S Safety Trainers black B1L110111W ESD CI HI HRO SC FO LG SR 46	1	1	4932493790	4058546509507
Armourtred™ S3S Safety Trainers black B1L110111W ESD CI HI HRO SC FO LG SR 47	1	1	4932493791	4058546509514
Armourtred™ S3S Safety Trainers black B1L110111W ESD CI HI HRO SC FO LG SR 48	1	1	4932493792	4058546509521

Armourtred™ S3S Safety Boots black 1M110111W ESD CI HI HRO SC FO LG SR

NEW

- Durable and protective safety boots for heavy duty jobsite protection.
- ENERGY FOAM heel cushioning system for superior energy return and maximum comfort.
- STEP-RELEASE™ heel for a convenient and rapid shoe removal.
- ROLLCAGE™ heel stabilizer for great stability even in demanding terrain.
- SHOCKSHIELD front hammer for added protection and rubber reinforced outsole with strong studs for best grip in demanding terrain.
- Lace pocket for storing shoelaces to prevent unintentional opening, tripping hazards and lace damage.
- Full grain cow leather upper to protect from water, dust and dirt and is easy to clean.
- Ladder grip sole area to climb up ladders safely.
- Scuff cap for increased toe cap protection and durability.
- Superior grip to prevent from slips.
- Heat Resistant outsole to 300°C.
- ESD (electrostatic discharge) certified.
- Certified according to EN ISO 20345:2022 S3S ESD CI HI HRO SC FO LG SR .



Description	Pack quantity	Min. order quantity	Article Number	EAN Code
Armourtred™ S3S Safety Boots black 1M110111W ESD CI HI HRO SC FO LG SR 39	1	1	4932493763	4058546509231
Armourtred™ S3S Safety Boots black 1M110111W ESD CI HI HRO SC FO LG SR 40	1	1	4932493764	4058546509248
Armourtred™ S3S Safety Boots black 1M110111W ESD CI HI HRO SC FO LG SR 41	1	1	4932493765	4058546509255
Armourtred™ S3S Safety Boots black 1M110111W ESD CI HI HRO SC FO LG SR 42	1	1	4932493766	4058546509262
Armourtred™ S3S Safety Boots black 1M110111W ESD CI HI HRO SC FO LG SR 43	1	1	4932493767	4058546509279
Armourtred™ S3S Safety Boots black 1M110111W ESD CI HI HRO SC FO LG SR 44	1	1	4932493768	4058546509286
Armourtred™ S3S Safety Boots black 1M110111W ESD CI HI HRO SC FO LG SR 45	1	1	4932493769	4058546509293
Armourtred™ S3S Safety Boots black 1M110111W ESD CI HI HRO SC FO LG SR 46	1	1	4932493770	4058546509309
Armourtred™ S3S Safety Boots black 1M110111W ESD CI HI HRO SC FO LG SR 47	1	1	4932493771	4058546509316
Armourtred™ S3S Safety Boots black 1M110111W ESD CI HI HRO SC FO LG SR 48	1	1	4932493772	4058546509323

Armourtred™ S7S Safety Boots black B1M110111W CI HI HRO SC FO LG SR

NEW

- Durable and protective safety boots for heavy duty jobsite protection.
- ENERGY FOAM heel cushioning system for superior energy return and maximum comfort.
- STEP-RELEASE™ heel for a convenient and rapid shoe removal.
- ROLLCAGE™ heel stabilizer for great stability even in demanding terrain.
- SHOCKSHIELD front hammer for added protection and rubber reinforced outsole with strong studs for best grip in demanding terrain.
- BOA® Fit System delivers micro adjustable precision fit, engineered to perform in the toughest conditions.
- Sympatex® waterproof membrane to stay dry.
- Microfiber light weight upper to protect from water, dust and dirt and is easy to clean.
- Ladder grip sole area to climb up ladders safely.
- Scuff cap for increased toe cap protection and durability.
- Heat Resistant outsole to 300°C.
- Cold insulation of outsole complex.
- Certified according to EN ISO 20345:2022 S7S CI HI HRO SC FO LG SR .



Description	Pack quantity	Min. order quantity	Article Number	EAN Code
Armourtred™ S7S Safety Boots black B1M110111W CI HI HRO SC FO LG SR 39	1	1	4932493793	4058546509538
Armourtred™ S7S Safety Boots black B1M110111W CI HI HRO SC FO LG SR 40	1	1	4932493794	4058546509545
Armourtred™ S7S Safety Boots black B1M110111W CI HI HRO SC FO LG SR 41	1	1	4932493795	4058546509552
Armourtred™ S7S Safety Boots black B1M110111W CI HI HRO SC FO LG SR 42	1	1	4932493796	4058546509569
Armourtred™ S7S Safety Boots black B1M110111W CI HI HRO SC FO LG SR 43	1	1	4932493797	4058546509576
Armourtred™ S7S Safety Boots black B1M110111W CI HI HRO SC FO LG SR 44	1	1	4932493798	4058546509583
Armourtred™ S7S Safety Boots black B1M110111W CI HI HRO SC FO LG SR 45	1	1	4932493799	4058546509590
Armourtred™ S7S Safety Boots black B1M110111W CI HI HRO SC FO LG SR 46	1	1	4932493800	4058546509606
Armourtred™ S7S Safety Boots black B1M110111W CI HI HRO SC FO LG SR 47	1	1	4932493801	4058546509613
Armourtred™ S7S Safety Boots black B1M110111W CI HI HRO SC FO LG SR 48	1	1	4932493802	4058546509620

Armourtred™ S7S Safety Boots black 1H110111W CI HI AN HRO SC FO LG SR

NEW

- Durable and protective safety boots for heavy duty jobsite protection.
- ENERGY FOAM heel cushioning system for superior energy return and maximum comfort.
- STEP-RELEASE™ heel for a convenient and rapid shoe removal.
- ROLLCAGE™ heel stabilizer for great stability even in demanding terrain.
- SHOCKSHIELD front hammer for added protection and rubber reinforced outsole with strong studs for best grip in demanding terrain.
- Sympatex® waterproof membrane to stay dry.
- Lace pocket for storing shoelaces to prevent unintentional opening, tripping hazards and lace damage.
- Full grain cow leather upper to protect from water, dust and dirt and is easy to clean.
- Ankle protectors for added durability and protection.
- Ladder grip sole area to climb up ladders safely.
- Scuff cap for increased toe cap protection and durability.
- Heat Resistant outsole to 300°C.
- Cold insulation of outsole complex.
- Certified according to EN ISO 20345:2022 S7S CI HI AN HRO SC FO LG SR .



Description	Pack quantity	Min. order quantity	Article Number	EAN Code
Armourtred™ S7S Safety Boots black 1H110111W CI HI AN HRO SC FO LG SR 39	1	1	4932493773	4058546509330
Armourtred™ S7S Safety Boots black 1H110111W CI HI AN HRO SC FO LG SR 40	1	1	4932493774	4058546509347
Armourtred™ S7S Safety Boots black 1H110111W CI HI AN HRO SC FO LG SR 41	1	1	4932493775	4058546509354
Armourtred™ S7S Safety Boots black 1H110111W CI HI AN HRO SC FO LG SR 42	1	1	4932493776	4058546509361
Armourtred™ S7S Safety Boots black 1H110111W CI HI AN HRO SC FO LG SR 43	1	1	4932493777	4058546509378
Armourtred™ S7S Safety Boots black 1H110111W CI HI AN HRO SC FO LG SR 44	1	1	4932493778	4058546509385
Armourtred™ S7S Safety Boots black 1H110111W CI HI AN HRO SC FO LG SR 45	1	1	4932493779	4058546509392
Armourtred™ S7S Safety Boots black 1H110111W CI HI AN HRO SC FO LG SR 46	1	1	4932493780	4058546509408
Armourtred™ S7S Safety Boots black 1H110111W CI HI AN HRO SC FO LG SR 47	1	1	4932493781	4058546509415
Armourtred™ S7S Safety Boots black 1H110111W CI HI AN HRO SC FO LG SR 48	1	1	4932493782	4058546509422

ARMOURTRED™ Lace Replacement

- Replacement Lace suitable for all MILWAUKEE® ARMOURTRED™ safety footwear.
- 120cm suitable for all low cut versions sizes 39 - 48.
- 160cm suitable for all low cut versions sizes 39 - 48.
- 200cm suitable for all low cut versions sizes 39 - 48.
- Available in black colour.



Description	Colour	Pack quantity	Min. order quantity	Article Number	EAN Code
ARMOURTRED™ Lace Replacement Black Low Cut 120 cm	Black	1	1	4932501765	4058546644819
ARMOURTRED™ Lace Replacement Black Mid Cut 160 cm	Black	1	1	4932501766	4058546644826
ARMOURTRED™ Lace Replacement Black Hi Cut 200 cm	Black	1	1	4932501767	4058546644833

FLEXTRED™ Lace Replacement

- Replacement Lace suitable for all MILWAUKEE® FLEXTRED™ safety footwear.
- 120cm suitable for all low cut versions sizes 36 - 48.
- 140cm suitable for all mid cut versions sizes 36 - 41.
- 160cm suitable for all mid cut versions sizes 42 - 48.
- Available in black and red colour.



Description	Colour	Pack quantity	Min. order quantity	Article Number	EAN Code
FLEXTRED™ Lace Replacement Red Low Cut 120 cm	Red	1	1	4932501675	4058546643911
FLEXTRED™ Lace Replacement Red Mid Cut 140 cm	Red	1	1	4932501676	4058546643928
FLEXTRED™ Lace Replacement Black Low Cut 120 cm	Black	1	1	4932501672	4058546643881
FLEXTRED™ Lace Replacement Black Mid Cut 140 cm	Black	1	1	4932501673	4058546643898
FLEXTRED™ Lace Replacement Black Mid Cut 160 cm	Black	1	1	4932501674	4058546643904
FLEXTRED™ Lace Replacement Red Mid Cut 160 cm	Red	1	1	4932501677	4058546643935

ARMOURTRED™ Insole Replacement

- Replacement Insole suitable for all MILWAUKEE® ARMOURTRED™ safety footwear.
- Ergonomic design for advanced stability in safety shoes.
- Foam cushioning in key areas to enhance comfort and reduce heel impact.
- ESD construction.
- Available sizes: 39-48.



Description	Shoe size (EU/UK)	Pack quantity	Min. order quantity	Article Number	EAN Code
ARMOURTRED™ Insole Replacement 39	39/6	1	1	4932501340	4058546640569
ARMOURTRED™ Insole Replacement 40	40/6.5	1	1	4932501341	4058546640576
ARMOURTRED™ Insole Replacement 41	41/7	1	1	4932501342	4058546640583
ARMOURTRED™ Insole Replacement 42	42/8	1	1	4932501343	4058546640590
ARMOURTRED™ Insole Replacement 43	43/9	1	1	4932501344	4058546640606
ARMOURTRED™ Insole Replacement 44	44/10	1	1	4932501345	4058546640613
ARMOURTRED™ Insole Replacement 45	45/10.5	1	1	4932501346	4058546640620
ARMOURTRED™ Insole Replacement 46	46/11	1	1	4932501347	4058546640637
ARMOURTRED™ Insole Replacement 47	47/12	1	1	4932501348	4058546640644
ARMOURTRED™ Insole Replacement 48	48/13	1	1	4932501349	4058546640651



FLEXTRED™ Insole Replacement

- Replacement Insole suitable for all MILWAUKEE® FLEXTRED™ safety footwear.
- Ergonomic design for advanced stability in safety shoes.
- Foam cushioning in key areas to enhance comfort and reduce heel impact.
- ESD construction.
- Available sizes: 36-48.



Description	Shoe size (EU/UK)	Pack quantity	Min. order quantity	Article Number	EAN Code
FLEXTRED™ Insole Replacement 36	36/3	1	1	4932501324	4058546640408
FLEXTRED™ Insole Replacement 41	41/7	1	1	4932501329	4058546640453
FLEXTRED™ Insole Replacement 42	42/8	1	1	4932501330	4058546640460
FLEXTRED™ Insole Replacement 43	43/9	1	1	4932501331	4058546640477
FLEXTRED™ Insole Replacement 44	44/10	1	1	4932501332	4058546640484
FLEXTRED™ Insole Replacement 45	45/10.5	1	1	4932501333	4058546640491
FLEXTRED™ Insole Replacement 46	46/11	1	1	4932501334	4058546640507
FLEXTRED™ Insole Replacement 47	47/12	1	1	4932501335	4058546640514
FLEXTRED™ Insole Replacement 48	48/13	1	1	4932501336	4058546640521
FLEXTRED™ Insole Replacement 37	37/4	1	1	4932501325	4058546640415
FLEXTRED™ Insole Replacement 38	38/5	1	1	4932501326	4058546640422
FLEXTRED™ Insole Replacement 39	39/6	1	1	4932501327	4058546640439
FLEXTRED™ Insole Replacement 40	40/6.5	1	1	4932501328	4058546640446



PACKOUT™

MOST VERSATILE
DURABLE
MODULAR STORAGE SYSTEM



SITE

TRANSIT

SHOP



SCAN NOW TO
VIRTUALLY
BUILD YOUR
PACKOUT™
SYSTEMS

PACKOUT™ 3 piece set

- 1 x PACKOUT™ trolley box
- 1 x PACKOUT™ large box
- 1 x PACKOUT™ box



Contents	Pack quantity	Min. order quantity	Article Number	EAN Code
1 x PACKOUT™ trolley box, 1 x PACKOUT™ large box, 1 x PACKOUT™ box	3	1	4932464244	4058546221898

PACKOUT™ transportation kit

- 1 x PACKOUT™ customisable work surface
- 1 x PACKOUT™ 2 drawer tool box
- 1 x PACKOUT™ 3 drawer tool box
- 1 x PACKOUT™ flat trolley



Description	Dimensions (Outer) (H x W x D / mm)	Pack quantity	Min. order quantity	Article Number	EAN Code
PACKOUT™ transportation kit	972 x 620 x 480	4	1	4932492892	4058546477639

PACKOUT™ starter set

- 1 x PACKOUT™ trolley box
- 1 x PACKOUT™ 2-drawers tool box
- 1 x PACKOUT™ slim organiser



Description	Pack quantity	Min. order quantity	Article Number	EAN Code
PACKOUT™ starter set	3	1	4932479957	4058546377519

PACKOUT™ rolling drawer

- Access your tools without unstacking boxes on top.
- Constructed with impact resistant polymers for jobsite durability.
- 113 kg weight capacity on top.
- 68 kg weight capacity inside.
- Metal reinforced corners for extra durability.
- Robust 228 mm all terrain wheels.
- Divider set and tray included for extra internal organisation.
- Side Mount Tool Box Attachments fit on the metal bars.
- Part of the PACKOUT™ modular storage system.



Description	Dimensions (Outer) (H x W x D / mm)	Pack quantity	Min. order quantity	Article Number	EAN Code
PACKOUT™ rolling drawer	665 x 570 x 480	1	1	4932498651	4058546525200

Master Mechanics PACKOUT™ set

- Fully equipped PACKOUT™ filled with essential tools, neatly placed in foam inserts for best organization.
- FOUR FLAT™ sides on socket deter rolling and provide a wrench-ready design.
- 90 Tooth count ratchet design with 4° of arc swing for tight work spaces.
- MAX BITE™ combination spanner up to 25% more torque for better grip on rounded bolts.
- 144 Tooth ratcheting combination spanners teeth provide a 2.5° arc swing allowing access in tighter spaces.
- PACKOUT™ most versatile, durable modular storage system.
- Each filled box is also available individually for maximum flexibility.



Description	Pack quantity	Min. order quantity	Article Number	EAN Code
① 76 pc Filled PACKOUT™ Screwdrivers, Pliers and Hammers Set	76	1		
6pc Demolition Set PACKOUT™ Foam Insert (4932501875), 44pc Screwdriver and Circlipplier Set PACKOUT™ Foam Insert (4932501876), 17pc Hook and Pick Set PACKOUT™ Foam Insert (4932501877), 9pc Plier Set PACKOUT™ Foam Insert (4932501878)			4932501866	4058546645823
② 244 pc Filled PACKOUT™ 1/4", 3/8" and 1/2" Drive Ratchets and Sockets Set	244	1		
68pc 1/4" Ratchet and Socket Set PACKOUT™ Foam Insert (4932501867), 67pc 3/8" Ratchet and Socket Set PACKOUT™ Foam Insert (4932501868), 42pc 1/2" Socket Set PACKOUT™ Foam Insert (4932501869), 67pc 1/2" Ratchet and Bit Socket Set PACKOUT™ Foam Insert (4932501870)			4932501864	4058546645809
③ 62 pc Filled PACKOUT™ Spanners Set	62	1		
19pc MAX BITE Combination Spanner Set PACKOUT™ Foam Insert (4932501865), 17pc MAX BITE Ratcheting Combination Spanner Set PACKOUT™ Foam Insert (4932501872), 12pc Double Ring Offset Spanner Set PACKOUT™ Foam Insert (4932501873), 14pc Double Open End Spanner Set PACKOUT™ Foam Insert (4932501874)			4932501865	4058546645816
④ 382 Master Mechanics PACKOUT™ Hand Tool set	382	1		
244pc Filled PACKOUT™ 1/4", 3/8" and 1/2" Drive Ratchets and Sockets (4932501864), 62pc Filled PACKOUT™ Spanners (4932501865), 76pc Filled PACKOUT™ Screwdrivers, Pliers and Hammers Set (4932501866), PACKOUT™ Flat Trolley (4932471068), PACKOUT™ Customisable Work Surface (4932472128), PACKOUT™ Side Mount Hand Tool Holder (4932498644), PACKOUT™ Side Mount Tray (4932498647), SHOCKWAVE™ IMPACT DUTY bit set (48 pc) (4932492005)			4932501863	4058546645793

PACKOUT™ trolley box

- Part of the PACKOUT™ modular storage system.
- Constructed with impact resistant polymers for jobsite durability.
- 113 kg weight capacity.
- Industrial grade extension handle.
- Oversized Ø 228 mm all terrain wheels.
- IP65 rated weather seal to keep out rain and jobsite debris.
- Metal reinforced corners.
- Metal reinforced locking point.
- Interior organiser tray.
- Mounting location for the ONE-KEY™ TICK™.



Description	Dimensions (Outer) (H x W x D / mm)	Pack quantity	Min. order quantity	Article Number	EAN Code
PACKOUT™ trolley box	650 x 561 x 472	1	1	4932464078	4058546220235



PACKOUT™ 2 wheeled cart

- 2 integrated PACKOUT™ mounting locations for additional storage options.
- Integrated holder for longer tools, such as levels.
- 180 kg weight capacity.
- 25 cm in-board wheels easily roll through doorways.
- Folding base plate for easy storage.
- Part of the PACKOUT™ modular storage system.
- Constructed with impact resistant polymers for jobsite durability.



Description	Dimensions (Outer) (H x W x D / mm)	Pack quantity	Min. order quantity	Article Number	EAN Code
PACKOUT™ 2 wheeled cart	290 x 1200 x 510	1	1	4932472131	4058546325275



PACKOUT™ rolling tool chest

- Dual Stack Top allows to transport 2 PACKOUT™ stacks onto the jobsite.
- 23 cm all-terrain wheels for easy rolling through rough jobsite terrain.
- Industrial grade extension handle supports up to 113 kg.
- Protective lid seal helps prevent damage to the tools from water and jobsite debris.
- Extra storage capacity for large tools and jobsite materials.
- Constructed with impact resistant polymers for jobsite durability.
- Part of the PACKOUT™ modular storage system.



Description	Dimensions (Outer) (H x W x D / mm)	Pack quantity	Min. order quantity	Article Number	EAN Code
PACKOUT™ rolling tool chest	401 x 965 x 609	1	1	4932478161	4058546340940



PACKOUT™ flat trolley

- 113kg weight capacity.
- Durable casters to easily roll with heavy load on a jobsite.
- Includes 1 locking brake and 2 side locks to stop the trolley and easily connect the PACKOUT™ boxes and bags.
- Part of the PACKOUT™ modular storage system.



Description	Dimensions (Outer) (H x W x D / mm)	Pack quantity	Min. order quantity	Article Number	EAN Code
PACKOUT™ flat trolley	193 x 620 x 480	1	1	4932471068	4058546286965



PACKOUT™ boxes

- Part of the PACKOUT™ modular storage system.
- Constructed with impact resistant polymers for jobsite durability.
- IP65 rated weather seal to keep out rain and jobsite debris.
- Metal reinforced corners.
- Metal reinforced locking point.
- Interior organiser trays.
- Mounting location for the ONE-KEY™ TICK™.
- Metal reinforced top handle for easier carrying (only on the large box).

Description	Dimensions (Outer) (H x W x D / mm)	Pack quantity	Min. order quantity	Article Number	EAN Code
① PACKOUT™ large box	282 x 561 x 411	1	1	4932464079	4058546220242
② PACKOUT™ box	165 x 561 x 411	1	1	4932464080	4058546220259



PACKOUT™ drawer tool boxes

- Easy access to stored items, even with other PACKOUT™ boxes stacked on top.
- Steel ball bearing slides support up to 11 kg of weight per drawer.
- Quick-Adjust Dividers in each drawer to fully customise the layout for better organisation.
- Locking security bar prevents an unwanted opening of drawers during transit.
- Allows to lock the drawers with a padlock for theft protection.
- Constructed with impact resistant polymers and metal reinforced corners for jobsite durability.
- Part of the PACKOUT™ modular storage system.

Description	Dimensions (Outer) (H x W x D / mm)	Pack quantity	Min. order quantity	Article Number	EAN Code
PACKOUT™ 4 drawer tool box	363 x 564 x 414	1	1	4932493189	4058546480608
PACKOUT™ 2 drawer tool box	363 x 564 x 414	1	1	4932472129	4058546325251
PACKOUT™ 3 drawer tool box	363 x 564 x 414	1	1	4932472130	4058546325268
PACKOUT™ 2+1 drawer tool box	363 x 564 x 414	1	1	4932493190	4058546480615



PACKOUT™ XL tool box

- Extra storage capacity for large power tools, such as band saws, angle grinders and hammers.
- 45 kg total weight capacity.
- Part of the PACKOUT™ modular storage system.
- Constructed with impact resistant polymers for jobsite durability.
- IP65 rated weather seal to keep out rain and jobsite debris.
- Metal reinforced corners.
- Interior organiser tray for smaller accessories.
- Mounting location for the ONE-KEY™ TICK™.



Description	Dimensions (Outer) (H x W x D / mm)	Pack quantity	Min. order quantity	Article Number	EAN Code
PACKOUT™ XL tool box	422 x 554 x 394	1	1	4932501784	4058546645007

PACKOUT™ cabinet

- Stacks on PACKOUT™ boxes.
- Hangs on PACKOUT™ Wall Mounting Plates.
- Secure stacking and hanging due to lock mechanism on bottom and rear.
- Front door to easy access stored tools and items inside. Door can be slid into the box to make access easy and comfortable.
- Weight capacity: 22 kg.
- Constructed with impact resistant material.
- Part of the PACKOUT™ modular storage system.



Description	Dimensions (Outer) (H x W x D / mm)	Pack quantity	Min. order quantity	Article Number	EAN Code
PACKOUT™ cabinet	381 x 508 x 381	1	1	4932480623	4058546409081



PACKOUT™ organisers

- Part of the PACKOUT™ modular storage system.
- Constructed with impact resistant polymers for jobsite durability.
- The interior features 10 removable & mountable bins that can be mounted onto common jobsite materials for easy access.
- IP65 rated weather seal to keep out rain and jobsite debris.
- No-travel bins seals to prevent the bins contents from migrating between bins during transport.



Description	Dimensions (Outer) (H x W x D / mm)	Pack quantity	Min. order quantity	Article Number	EAN Code
PACKOUT™ organiser	117 x 500 x 386	1	1	4932464082	4058546220273

PACKOUT™ compact organiser

- Part of the PACKOUT™ modular storage system.
- Constructed with impact resistant polymers for jobsite durability.
- The interior features 5 removable & mountable bins that can be mounted onto common jobsite materials for easy access.
- IP65 rated weather seal to keep out rain and jobsite debris.
- No-travel bins seals to prevent the bins contents from migrating between bins during transport.



Description	Dimensions (Outer) (H x W x D / mm)	Pack quantity	Min. order quantity	Article Number	EAN Code
PACKOUT™ compact organiser	117 x 249 x 386	1	1	4932464083	4058546220280

PACKOUT™ slim organiser

- Part of the PACKOUT™ modular storage system.
- Constructed with impact resistant polymers for jobsite durability.
- Interior features 2 large bins and 8 small bins. All bins contain dividers.
- No travel bin seals to prevent the bins contents from migrating between bins during transportation.
- IP 65 rated weather seal to keep out rain and jobsite debris.



Description	Dimensions (Outer) (H x W x D / mm)	Pack quantity	Min. order quantity	Article Number	EAN Code
PACKOUT™ slim organiser	64 x 500 x 414	1	1	4932471064	4058546286927

PACKOUT™ compact slim organiser

- Part of the PACKOUT™ modular storage system.
- Constructed with impact resistant polymers for jobsite durability.
- Interior features 1 large bin and 4 small bins. All bins contain dividers.
- No travel bin seals to prevent the bins contents from migrating between bins during transportation.
- IP 65 rated weather seal to keep out rain and jobsite debris.



Description	Dimensions (Outer) (H x W x D / mm)	Pack quantity	Min. order quantity	Article Number	EAN Code
PACKOUT™ compact slim organiser	64 x 249 x 411	1	1	4932471065	4058546286934

PACKOUT™ deep organiser

- 50% higher than the standard PACKOUT™ organiser - ideal to store tools, batteries, chargers, larger fittings and other equipment.
- Quick Adjust Dividers allow users to customise storage to their needs.
- 22 kg total weight capacity.
- Part of the PACKOUT™ modular storage system.
- Constructed with impact resistant polymers for jobsite durability.
- IP 65 rated weather seal to keep out rain and jobsite debris.

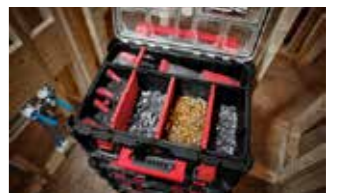

Description	Dimensions (Outer) (H x W x D / mm)	Pack quantity	Min. order quantity	Article Number	EAN Code
PACKOUT™ deep organiser	178 x 507 x 386	1	1	4932478625	4058546348182

PACKOUT™ tip bin organiser

NEW

- Constructed with impact resistant polymers for jobsite durability.
- Features 8 small and 2 large transparent bins.
- Bins can be tipped and taken out completely.
- Inside weight capacity 22.7 kg.
- Ergonomic handle for comfortable hold and transport.
- Stores small items like screws, bits, nails, washers, markers, knives.
- Hangs on the wall mounting plates and can be stacked on other PACKOUT™.



Description	Dimensions (Outer) (H x W x D / mm)	Pack quantity	Min. order quantity	Article Number	EAN Code
PACKOUT™ tip bin organiser	170 x 500 x 386	1	1	4932498323	4058546521929

Large bin for PACKOUT™ tip bin organiser

- Transparent bin to fit into PACKOUT™ tip bin organiser.
- Includes removable divider.



Description	Pack quantity	Min. order quantity	Article Number	EAN Code
Large bin for PACKOUT™ tip bin organiser	1	1	4932500137	4058546573010

PACKOUT™ crate

- Versatile stacking options: vertical and horizontal.
- 22 kg weight capacity.
- Large storage capacity for all kind of tools.
- Other PACKOUT™ products can be stacked on top of the crate.
- Part of the PACKOUT™ modular storage system.



Description	Dimensions (Outer) (H x W x D / mm)	Pack quantity	Min. order quantity	Article Number	EAN Code
PACKOUT™ crate	251 x 475 x 389	1	1	4932471724	4058546296230

PACKOUT™ compact tool box

- Quick-Adjust Dividers allow users to store and organize larger equipment and accessories, such as fittings, connectors or caulk.
- Enough storage capacity to fit power tools like circular saws, grinders, drill drivers.
- 34 kg weight capacity.
- Constructed with impact resistant polymers for jobsite durability.
- IP 65 rated weather seal to keep out rain and jobsite debris.
- Part of the PACKOUT™ modular storage system.



Description	Dimensions (Outer) (H x W x D / mm)	Pack quantity	Min. order quantity	Article Number	EAN Code
PACKOUT™ compact tool box	330 x 249 x 411	1	1	4932471723	4058546292232

PACKOUT™ hard cooler

- Double premium insulation keeps contents cold for up to 30 hours.
- IP 65 Food Grade Leak-Proof Liner prevents leakages and protects contents from debris and dust.
- Integrated bottle opener.
- Removable tray for separate storage of personal items to keep them elevated above icy water.
- 15 l capacity.
- Constructed with impact resistant polymers for jobsite durability.
- Part of the PACKOUT™ modular storage system



Description	Dimensions (Outer) (H x W x D / mm)	Pack quantity	Min. order quantity	Article Number	EAN Code
PACKOUT™ hard cooler	330 x 249 x 411	1	1	4932471722	4058546296216



PACKOUT™ XL cooler

- Double premium insulation keeps contents cold for up to 5 days.
- IP 65 Food Grade Leak-Proof Liner prevents leakages and protects contents from debris and dust.
- 38 l capacity.
- Removable tray for separate storage of personal items to keep them elevated above icy water.
- Integrated bottle opener.
- Constructed with impact resistant polymers for jobsite durability.
- Part of the PACKOUT™ modular storage system.



Description	Dimensions (Outer) (H x W x D / mm)	Pack quantity	Min. order quantity	Article Number	EAN Code
PACKOUT™ XL cooler	432 x 584 x 406	1	1	4932478648	4058546348410



PACKOUT™ 38 cm closed tote tool bag

- Highest durability due to 1680D and 1800D ballistic material.
- Layering of fabrics increase the durability and performance.
- Reinforced edges, metal rings and springs for longest lifetime.
- 65 pockets for best organisation of tools.
- Shoulder strap and ergonomic carry handle.
- Holder for duct tapes for easy access.
- Molded PACKOUT™ base protects against humidity and debris.
- Part of the PACKOUT™ modular storage system.



Description	Dimensions (Outer) (H x W x D / mm)	Pack quantity	Min. order quantity	Article Number	EAN Code
PACKOUT™ 38 cm closed tote tool bag	510 x 460 x 260	1	1	4932493623	4058546484941



PACKOUT™ structured backpack

- Highest durability due to 1680D and 1800D ballistic material.
- 42 pockets for best organisation of tools.
- 22.7 kg weight capacity.
- Best comfort due to cushioned back pad and shoulder straps.
- Ergonomic carry handle, lays down flat to save space.
- Molded PACKOUT™ base protects against humidity and debris.
- Part of the PACKOUT™ modular storage system.



Description	Dimensions (Outer) (H x W x D / mm)	Pack quantity	Min. order quantity	Article Number	EAN Code
PACKOUT™ structured backpack	630 x 430 x 230	1	1	4932498633	4058546525026



PACKOUT™ pro tote toolbag

- Highest durability due to 1680D and 1800D ballistic material.
- Layering of fabrics increase the durability and performance.
- Reinforced edges, metal rings and springs for longest lifetime.
- 22.7 kg weight capacity.
- Numerous pockets for best organisation of tools.
- Shoulder strap and ergonomic carry handle.
- Holder for duct tapes for easy access.
- Molded PACKOUT™ base protects against humidity and debris.
- Part of the PACKOUT™ modular storage system.



Description	Type	Dimensions (Outer) (H x W x D / mm)	Pack quantity	Min. order quantity	Article Number	EAN Code
① PACKOUT™ 38 cm pro tote toolbag	35 internal and external pockets for best organisation.	460 x 440 x 270	1	1	4932498634	4058546525033
② PACKOUT™ 25 cm pro tote toolbag	39 internal and external pockets for best organisation.	480 x 380 x 230	1	1	4932493622	4058546484934



PACKOUT™ tote toolbag

- Part of the PACKOUT™ modular storage system.
- 1680 ballistic material construction.
- Impact resistant molded base.
- All metal hardware.
- Durable overmolded handle.



Description	Dimensions (Outer) (H x W x D / mm)	No. of pockets	Pack quantity	Min. order quantity	Article Number	EAN Code
① 25 cm tote toolbag	300 x 250 x 320	28	1	1	4932464084	4058546220297
② 40 cm tote toolbag	250 x 400 x 430	31	1	1	4932464085	4058546220303
③ 50 cm tote toolbag	280 x 500 x 430	32	1	1	4932464086	4058546220310



PACKOUT™ duffel bag

- Part of the PACKOUT™ modular storage system.
- Made from 1680D Ballistic Material for jobsite durability.
- Impact resistant polymer base protects contents from water, dirt and tear.
- Large storage capacity for larger tools.
- Cushioned shoulder strap, top and side handles for flexible carry.



Description	Dimensions (Outer) (H x W x D / mm)	Pack quantity	Min. order quantity	Article Number	EAN Code
① 38 cm PACKOUT™ duffel bag	427 x 381 x 254	1	1	4932471066	4058546286941
② 50 cm PACKOUT™ duffel bag	427 x 508 x 279	1	1	4932471067	4058546286958



PACKOUT™ backpack

- Part of the PACKOUT™ modular storage system.
- Made from 1680D ballistic material for jobsite durability.
- 48 total pockets including a hard-shell protected instrument pocket.
- Extra back padding, chest strap, attachment strap for rolling bags and heavy duty harness for ultimate jobsite comfort.
- Impact resistant polymer base protects contents from water and dirt and also allows backpack to stand up.



Description	Dimensions (Outer) (H x W x D / mm)	Pack quantity	Min. order quantity	Article Number	EAN Code
PACKOUT™ backpack	508 x 381 x 292	1	1	4932471131	4058546287597



PACKOUT™ tech bag

- Part of the PACKOUT™ modular storage system.
- Made from 1680D ballistic material for jobsite durability.
- 58 total pockets. Hardshell protected instrument pocket.
- Secure and protected storage for laptops and tablets.
- Impact resistant polymer base protects contents from water, dirt and tear.



Description	Dimensions (Outer) (H x W x D / mm)	Pack quantity	Min. order quantity	Article Number	EAN Code
PACKOUT™ tech bag	432 x 432 x 279	1	1	4932471130	4058546287580



PACKOUT™ jobsite cooler

- Part of the PACKOUT™ modular storage system.
- 20l volume capacity with a dry compartment and a storage space for drinks.
- Extra insulation keeps contents cold for 24 hours.
- Impact resistant polymer base protects contents from water, dirt, and tear.
- Shoulder strap for easy transport.



Description	Dimensions (Outer) (H x W x D / mm)	Pack quantity	Min. order quantity	Article Number	EAN Code
PACKOUT™ jobsite cooler	406 x 394 x 254	1	1	4932471132	4058546287603



PACKOUT™ racking system

- E-Track mounting rails can be mounted on the wall in vehicles, shops or garages for ultimate versatility.
- Quick release design for easy mounting, height adjustment and removal of the shelves.
- Each shelf supports up to 22 kg of weight.
- Metal reinforced frame.
- Impact resistant polymer construction.
- Part of the PACKOUT™ modular storage system.



Description	Dimensions (Outer) (H x W x D / mm)	Pack quantity	Min. order quantity	Article Number	EAN Code
① PACKOUT™ racking system kit (2 shelves + E-track)	508 x 546 x 447	4	1	4932472127	4058546325237
② PACKOUT™ racking system - single shelf	99 x 533 x 422	1	1	4932478711	4058546349042
③ Vertical E-track for PACKOUT™ racking system 50 cm	25 x 90 x 508	2	1	4932478996	4058546362782



PACKOUT™ mounting plates

- Multiple mounting configurations.
- Turn PACKOUT™ into stationary shop storage.
- Connects to all MILWAUKEE® PACKOUT™ modular storage.
- Constructed with impact resistant polymers for highest durability.
- Metal reinforced mounting points for carrying high weights.
- Organise your shop together with PACKOUT™ boxes and wall accessories.

Description	Dimensions (Outer) (H x W x D / mm)	Pack quantity	Min. order quantity	Article Number	EAN Code
① PACKOUT™ mounting plate	28 x 594 x 467	1	1	4932471638	4058546295370
② PACKOUT™ compact mounting plate	25 x 254 x 508	1	1	4932480621	4058546409067
③ PACKOUT™ XL mounting plate	25 x 762 x 508	1	1	4932480622	4058546409074



PACKOUT™ tool box side mount attachments

- Hang on the side of PACKOUT™ to increase storage possibilities.
- Impact resistant material.
- Part of the PACKOUT™ modular storage system.

Description	Dimensions (Outer) (H x W x D / mm)	Pack quantity	Min. order quantity	Article Number	EAN Code
① PACKOUT™ side mount adapter (2 pack)	52 x 122 x 45	2	1	4932498643	4058546525125
② PACKOUT™ side mount hand tool holder	154 x 294 x 120	1	1	4932498644	4058546525132
③ PACKOUT™ side mount M18™ battery rack	135 x 292 x 68	1	1	4932498645	4058546525149
④ PACKOUT™ side mount M12™ battery rack	123 x 292 x 95	1	1	4932498646	4058546525156
⑤ PACKOUT™ side mount tray	125 x 294 x 140	1	1	4932498647	4058546525163
⑥ PACKOUT™ side mount mounting plate	240 x 420 x 68	1	1	4932498648	4058546525170
⑦ PACKOUT™ side mount long tool holder	upper part: 122 x 293 x 93; lower part: 156 x 360 x 115	1	1	4932498649	4058546525187
⑧ PACKOUT™ side mount 3-hook rail	120 x 290 x 110	1	1	4932498650	4058546525194



PACKOUT™ customisable work surface

- Marine grade plywood top provides smooth surface for light assembly work, writing, sketching or working on a laptop.
- Fastener-ready surface allows for easy mounting of common jobsite materials and larger tools on top of a PACKOUT™ stack.
- 22 kg weight capacity.
- Part of the PACKOUT™ modular storage system.
- Constructed with impact resistant polymers for jobsite durability.

Description	Dimensions (Outer) (H x W x D / mm)	Pack quantity	Min. order quantity	Article Number	EAN Code
PACKOUT™ customisable work surface	53 x 607 x 389	1	1	4932472128	4058546325244



PACKOUT™ tool tray

- Flexible additional organisation.
- Modular connectivity with PACKOUT™ components: stack on and store in other PACKOUT™ Tool Boxes.
- Fits inside of: PACKOUT™ Large Box, PACKOUT™ Trolley Box, PACKOUT™ XL Tool Box, PACKOUT™ Rolling Tool Chest.
- Top carry handle allows easy transport.
- Includes Quick-Adjust-Dividers for custom storage layouts.
- 11 kg weight capacity.
- Part of the PACKOUT™ modular storage system.



Description	Dimensions (Outer) (H x W x D / mm)	Pack quantity	Min. order quantity	Article Number	EAN Code
PACKOUT™ tool tray	127 x 503 x 297	1	1	4932480625	4058546409104

PACKOUT™ crate divider

- Separates the PACKOUT™ Crate into multiple storage zones.
- The back wing allows half width PACKOUT™ products to sit on top of the Crate.
- Mounting holes for the attachment of chargers and other items.
- Part of the PACKOUT™ modular storage system.



Description	Dimensions (Outer) (H x W x D / mm)	Pack quantity	Min. order quantity	Article Number	EAN Code
PACKOUT™ crate divider	234 x 330 x 94	1	1	4932480624	4058546409098

PACKOUT™ adaptor HD box

- Heavy duty boxes adaptor for PACKOUT™ system.
- Fits on top of PACKOUT™ boxes.
- Enables to carry heavy duty boxes on top of PACKOUT™ boxes for the most versatile storage solution.
- Made of impact resistant material.



Description	Dimensions (Outer) (H x W x D / mm)	Pack quantity	Min. order quantity	Article Number	EAN Code
PACKOUT™ adaptor HD box	117 x 500 x 386	1	1	4932464081	4058546220266

PACKOUT™ foam inserts

- Fully customisable - foam Insert allows you to fully customise your storage by cutting out custom pockets to securely store and protect your tools.
- Durable construction provides increased protection for tools.
- Optimised storage - allows easy access to the tools.
- Ref. 4932471428: Designed to fit in two PACKOUT™ boxes - tool box (4932464080) & large tool box (4932464079).
- Ref. 4932471927: Designed to fit in the PACKOUT™ trolley box (4932464078).



Description	Pack quantity	Min. order quantity	Article Number	EAN Code
PACKOUT™ foam insert	2	1	4932471428	4058546290566
PACKOUT™ trolley foam insert	1	1	4932471927	4058546298265
Foam insert for PACKOUT™ drawer tool boxes	2	1	4932479157	4058546369514

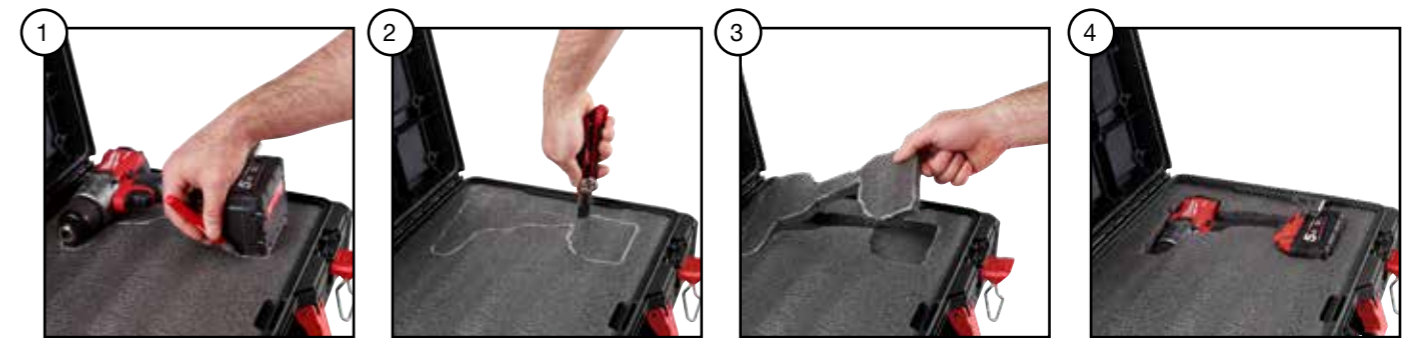

Slim foam insert for PACKOUT™ drawer tool boxes

- Fully customisable - foam insert allows you to fully customise your storage by cutting out custom shapes to securely store and protect your tools.
- Customise your foam insert in 4 easy steps:
 - Trace the shape of the product with an INKZALL™ marker.
 - Use a snap knife to cut the outline.
 - Peel out the layers of the foam to a desired depth.
 - Place the tool in the foam insert.
- Ref. 4932493993 contains 2 pieces of foam. 1 piece of foam fits the height of the drawers of the 4-drawer tool box (4932493189) and the slim drawer of the 2+1 drawer tool box (4932493190); 2 pieces of foam fit the height of the large drawer of the 2+1 drawer tool box (4932493190).



Description	Dimensions (Outer) (H x W x D / mm)	Pack quantity	Min. order quantity	Article Number	EAN Code
Slim foam insert for PACKOUT™ drawer tool boxes	91 x 414 x 318	2	1	4932493993	4058546511531

PACKOUT™ inserts

- Removable inserts for PACKOUT™ boxes and organisers.
- Ref. 4932478298: Organisation tray designed to fit PACKOUT™ trolley box (4932464078) and large box (4932464079).
- Ref. 4932478299: Set of organisation trays designed to fit PACKOUT™ box (4932464080).
- Ref. 4932478300: Set of organisation boxes designed to fit PACKOUT™ organiser (4932464082) and compact organiser (4932464083).
- Ref. 4932478301: Set of organisation boxes designed to fit PACKOUT™ slim organiser (4932471064) and compact slim organiser (4932471065).

Description	Pack quantity	Min. order quantity	Article Number	EAN Code
① Removable tray for PACKOUT™ trolley box and large box	1	1	4932478298	4058546344757
② Removable trays for PACKOUT™ box	4	1	4932478299	4058546344764
③ Removable bins for PACKOUT™ slim organiser and compact slim organiser	5	1	4932478301	4058546344788
④ Removable bins for PACKOUT™ organiser and compact organiser	5	1	4932478300	4058546344771
⑤ Drawer dividers for PACKOUT™ 3 drawer tool box	8	1	4932479104	4058546368982
⑥ Drawer dividers for PACKOUT™ 2 drawer tool box	8	1	4932479105	4058546368999



10pc PACKOUT™ drawer insulated electrician foam insert set

- Tested to 10,000 volts and guaranteed to 1,000 volts.
- Optimum leverage for easy and effortless work.
- Up to 60% less power required when cutting.
- Slim insulated coating for electrical applications in tight spaces.
- Tri-Lobe handle for maximum torque turning power.
- Anti roll handle.
- Premium foam for longer durability, laser cut sizes for easy and quick size identification and red background to identify quickly missing tools.

Description	Pack quantity	Min. order quantity	Article Number	EAN Code
10pc PACKOUT™ drawer insulated electrician foam insert set	10	1	4932493637	4058546485085

VDE Wire Stripping Plier 160mm (4932464573); VDE Long Round Nose Plier (4932464564); VDE Diagonal Cutter 160mm (4932464567); VDE Combination Plier 180mm (4932464572); TRILOBE VDE SCREWDRIVER SLOTTED 0.5 X 3 X 100 (4932478713); Voltage Tester (4932478719); TRI-LOBE VDE Screwdriver PZ 1x80mm (4932478725); PZ 2x100mm (4932478726); TRI-LOBE VDE SCREWDRIVER SLOTTED 0.8 X 4 X 100 (4932478715); 1.0 X 5.5 X 125 (4932478716)



MAX BITE™ spanner and plier set PACKOUT™ foam insert

- MAX BITE™ open-end grip reduces rounding and stripping.
- Rounded I-Beam handle for comfortable handling grip.
- Ink-filled labels for clear visibility.
- Water pump plier with V-groove jaws with profile for firmer grip, more precise fit and reduced slipping.
- Precision machined joint for maximum power transmission with optimum leverage for easy and effortless work.
- Fits perfectly into the PACKOUT™ Drawer Tool Boxes.
- Premium foam for longer durability, laser cut sizes for easy and quick size identification and red background to identify quickly missing tools.



Description	Pack quantity	Min. order quantity	Article Number	EAN Code
MAX BITE™ spanner and plier set PACKOUT™ foam insert 19 pc	19	1	4932493339	4058546482107

8mm, 9mm, 10mm, 11mm, 12mm, 13mm, 14mm, 15mm, 16mm, 17mm, 18mm, 19mm, 20mm, 21mm and 22 mm combination spanner; 205mm long nose plier, 160mm diagonal cutter, 180mm water pump plier, 150mm adjustable wrench

10pc PACKOUT™ drawer screwdriver & plier foam insert set

- High torque ergonomic tri-lobe handle design is optimised for maximum user comfort and ideal for high torque applications.
- Permanent visual driver identification allows users to easily identify the correct driver type from multiple orientations.
- Hardened magnetic tips deliver maximum durability and fastener retention.
- Maximum power transmission for optimum leverage for easy and effortless work.
- Soft touch head design due to rounded edges to prevent hand injuries.
- Premium foam for longer durability, laser cut sizes for easy and quick size identification and red background to identify quickly missing tools.

Description	Pack quantity	Min. order quantity	Article Number	EAN Code
10pc PACKOUT™ drawer screwdriver & plier foam insert set	10	1	4932493638	4058546485092

Adjustable Water Pump Plier 250mm (4932492459); Combination Plier 180mm (4932492462); Long Nose Pliers 205mm (4932492465); Diagonal Cutting Plier 160mm (4932492463); TRI-LOBE SCREWDRIVER PZ1 x 100 (4932471791); PZ2 x 125 (4932471793); TRI-LOBE SCREWDRIVER SL 0.5x3x75 (4932471775); SL 0.8x4x100 (4932471778); SL 1.0x5.5x125 (4932471779); SL 1.2x6.5x125 (4932471781)



8pc PACKOUT™ drawer plumbing foam insert set

- Water pump plier: double toothed jaw for maximum grip and induction hardened teeth with self-locking serration.
- Pliers: induction hardened cutting edges for longest lifetime.
- Hacksaw: tool free blade change for changing blades up to 10x faster.
- Mini copper tubing cutter: chrome rollers for added durability and extended performance.
- Premium foam for longer durability, laser cut sizes for easy and quick size identification and red background to identify quickly missing tools.



Description	Pack quantity	Min. order quantity	Article Number	EAN Code
8pc PACKOUT™ drawer plumbing foam insert set	8	1	4932493639	4058546485108

Adjustable Water Pump Plier 250mm (4932492459); Long Nose Pliers 205mm (4932492465); Diagonal Cutting Plier 160mm (4932492463); Reaming Pen (48224255); Compact Torpedo (4932472122); Compact Hacksaw (48220012); Constant Swing Copper Tubing Cutter 42mm (48229252); Mini Copper Tubing Cutter 22 mm (48229258)

6pc PACKOUT™ drawer woodworking foam insert set

- All metal core for maximum durability.
- Striking metal end cap for longer handle life.
- SHOCKSHIELD™ grip reduces peak vibration, helps reduce fatigue and offers best-in-class grip durability.
- Premium foam for longer durability, laser cut sizes for easy and quick size identification and red background to identify quickly missing tools.



Description	Pack quantity	Min. order quantity	Article Number	EAN Code
6pc PACKOUT™ drawer woodworking foam insert set	6	1	4932493641	4058546485122

1/4" Beveled Edge Chisel (4932479892); 1/2" Beveled Edge Chisel (4932479893); 3/4" Beveled Edge Chisel (4932479894); 1" Beveled Edge Chisel (4932479895); 10in Trim Puller (4932478252); Steel RIP Claw Hammer 16oz/450g (4932478653)

55pc PACKOUT™ drawer 3/8" ratchet and ratcheting combination spanner foam insert set

- Ratcheting mechanism with 90 tooth count and 4° arc swing (more work in tight spaces).
- Sockets offer four flat sides for anti-roll, wrench-readiness and better grip for hand tightening.
- Ratchet offers 2.5° arc swing and 144 tooth count for better functionality in tight spaces.
- Spanners offer MAXBITE™ open-end grip with up to 25% more torque and better grip on rounded bolts.
- Foldable hex and torx keys enable easy access & storage solution.
- Ergonomic handle provides comfortable and secure grip.
- Premium foam for longer durability, laser cut sizes for easy and quick size identification and red background to identify quickly missing tools.



Description	Pack quantity	Min. order quantity	Article Number	EAN Code
55pc PACKOUT™ drawer 3/8" ratchet and ratcheting combination spanner foam insert set	55	1	4932493640	4058546485115

Metric 3/8" Ratchet + Socket Set 32pc (4932464945); MAX BITE™ Ratcheting Metric Combination Spanner Set 7pc (4932464993); 8pc Metric Folding Hex Key Set (4932480978); 8pc Folding Torx Key Set (4932480979)

4pc PACKOUT™ drawer cutting & measuring foam insert set

- Tool free blade change of the hacksaw for changing blades up to 10x faster.
- Up to 4x more durable metal lock on snap knife for longest lifetime.
- Tape with anti-tear coating at the first 15cm of the blade enables highest durability.
- Premium foam for longer durability, laser cut sizes for easy and quick size identification and red background to identify quickly missing tools.



Description	Pack quantity	Min. order quantity	Article Number	EAN Code
4pc PACKOUT™ drawer cutting & measuring foam insert set	4	1	4932493642	4058546485139

Set Hacksaw 300mm (48220050); Snap Knife 18 mm (48221961); Mag Tape 5/27 (4932464599); INKZALL™ Marker Black (48223100)



8pc PACKOUT™ drawer pliers foam insert set

- Maximum power transmission for optimum leverage for easy and effortless work.
- Soft touch head design due to rounded edges to prevent hand injuries.
- Double toothed jaw for maximum grip and induction hardened teeth with self-locking serration.
- Curved box joints enable larger gripping capacity.
- Premium foam for longer durability, laser cut sizes for easy and quick size identification and red background to identify quickly missing tools.



Description	Pack quantity	Min. order quantity	Article Number	EAN Code
8pc PACKOUT™ drawer pliers foam insert set	8	1	4932493643	4058546485146
Adjustable Water Pump Plier 180mm (4932492458); Adjustable Water Pump Plier 250mm (4932492459); Adjustable Water Pump Plier 300mm (4932492460); Combination Plier 165mm (4932492461); Combination Plier 180mm (4932492462); Long Nose Plier 205mm (4932492465); Diagonal Cutting Plier 160mm (4932492463); HD Diagonal Cutting Plier 200mm (4932492464)				

Ratchet and socket PACKOUT™ Drawer foam insert

- 90 tooth design ratchet with 4° of arc swing for tight work spaces.
- FOUR FLAT™ sides on socket for an anti-roll and wrench-ready solution.
- Fits perfectly into the PACKOUT™ Drawer Tool Boxes.
- Premium foam for longer durability, laser cut sizes for easy and quick size identification and red background to identify quickly missing tools.

Description	Pack quantity	Min. order quantity	Article Number	EAN Code
① 1/2" Ratchet, socket and hex key set PACKOUT™ foam insert 70 pc	70	1	4932480716	4058546410018
1/2" drive ratchet; 10mm, 11mm, 12mm, 13mm, 14mm, 15mm, 16mm, 17mm, 18mm, 19mm, 20mm, 21mm, 22mm, 23mm, 24mm 1/2" drive standard sockets and 10mm, 11mm, 12mm, 13mm, 14mm, 15mm, 16mm, 17mm, 18mm, 19mm deep well sockets; 76mm and 127mm 1/2" drive extensions; 9 pc Hex key set; Shockwave™ Impact Rated Screwdriving Bits 2 x TX10 / 4 x TX15 / 5 x TX20 / 5 x TX25 / 5 x TX30 / 2 x TX40 / 1 x TX50, 1 x TX B07 / 1 x TX B08 / 1 x TX B09 / 1 x TX B010 / 1 x TX B015 / 1 x TX B020 / 1 x TX B025. 1 x Shockwave™ Impact Rated Bit Holders				
② 1/4" drive ratchet, socket, screwdriver and wrench set PACKOUT™ foam insert	35	1	4932480717	4058546410025
1/4" drive ratchet; 5mm, 5.5mm, 6mm, 7mm, 8mm, 9mm, 10mm, 11mm, 12mm, 13mm, 14mm, 15mm 1/4" drive standard and deep well sockets; 76mm and 152mm extensions, 1/4" driver universal joint; 6 Tri-Lobe screwdrivers (SL3 / SL 4 / SL5 / SL 6 / PH 1 / PH 2); 250mm adjustable wrench				



17pc PACKOUT™ drawer precision screwdriver foam insert set

- All metal core for up to 4x stronger for jobsite toughness.
- Longer shanks for more visibility & reach.
- 360° rotating back caps for more control.
- Precision machined bit tips offer for secure fit and longest lifetime.
- Chrome plated shanks increase tool life by reducing corrosion.
- Premium foam for longer durability, laser cut sizes for easy and quick size identification and red background to identify quickly missing tools.



Description	Pack quantity	Min. order quantity	Article Number	EAN Code
17pc PACKOUT™ drawer precision screwdriver foam insert set	17	1	4932493644	4058546485153
Precision Screwdriver Set 6pc (PH00/PH0/SL1.6/SL2/SL3.2/SL4) (4932471869); Torx Precision Screwdriver Set 6pc (T6,T7,T8,T9,T10,T15) (4932471870); Tester 0.5 X 3 X 65 (4932478719); TRI-LOBE S/Driver PH2x125 (4932471788); TRI-LOBE S/Driver SL 0.8x4x100 (4932471778); TRI-LOBE S/Driver T20x100 (4932471801); Demolition Driver (4932480975)				

PACKOUT™ tumbler

- Double wall vacuum insulation for all day hot & cold retention.
- Rotating magnetic closure for easy opening.
- 18/8 stainless steel for durability.
- Dishwasher safe.
- Twist and lock mechanism for connectivity with all PACKOUT™ components.

Description	Pack quantity	Min. order quantity	Article Number	EAN Code
PACKOUT™ tumbler 591 ml	1	6	4932479074	4058546368685
PACKOUT™ tumbler 887 ml	1	6	4932479075	4058546368692



Packout™ bottles chug lids

- Double wall vacuum insulation for all day hot & cold retention.
- 18/8 stainless steel for highest durability.
- Dishwasher safe.
- Lids are compatible throughout all PACKOUT™ bottles and mugs.
- Twist and lock mechanism for connectivity with all PACKOUT™ components.
- Part of the PACKOUT™ modular storage system.

Description	Dimensions (Outer) (H x W x D / mm)	Pack quantity	Min. order quantity	Article Number	EAN Code
① Packout™ bottle 532 ml chug lid red	267 x 80 x 80	1	8	4932493991	4058546511517
Packout™ bottle 532 ml chug lid black	267 x 80 x 80	1	8	4932493992	4058546511524
Packout™ bottle 710 ml chug lid red	305 x 86 x 86	1	8	4932493465	4058546483364
② Packout™ bottle 710 ml chug lid black	305 x 86 x 86	1	8	4932493466	4058546483371
③ Packout™ bottle 1065 ml chug lid red	318 x 100 x 100	1	6	4932493467	4058546483388
Packout™ bottle 1065 ml chug lid black	318 x 100 x 100	1	6	4932493468	4058546483395
④ PACKOUT™ bottle 355 ml sip lid red	178 x 79 x 79	1	8	4932498977	4058546528461
PACKOUT™ bottle 355 ml sip lid black	178 x 79 x 79	1	8	4932498978	4058546528478
⑤ Packout™ bottle 532 ml sip lid red	229 x 79 x 79	1	8	4932493473	4058546483449
Packout™ bottle 532 ml sip lid black	229 x 79 x 79	1	8	4932493474	4058546483456
⑥ Packout™ mug 532 ml sip lid red	229 x 79 x 120	1	6	4932493471	4058546483425
Packout™ mug 532 ml sip lid black	229 x 79 x 120	1	6	4932493472	4058546483432
⑦ PACKOUT™ chug lid	105 x 78 x 78	1	1	4932493464	4058546483357
⑧ Packout™ sip lid	66 x 78 x 78	1	1	4932493470	4058546483418



PACKOUT™ plastic bottles

- Impact resistant tritan plastic.
- Dishwasher safe.
- Lids are compatible throughout all PACKOUT™ plastic bottles.
- Twist and lock mechanism for connectivity with all PACKOUT™ components.
- Part of the PACKOUT™ modular storage system.

Description	Dimensions (Outer) (H x W x D / mm)	Pack quantity	Min. order quantity	Article Number	EAN Code
① PACKOUT™ 740 ml plastic bottle chug lid red	286 x 79 x 79	1	8	4932498636	4058546525057
PACKOUT™ 740 ml plastic bottle chug lid black	286 x 79 x 79	1	8	4932498639	4058546525088
PACKOUT™ 1005 ml plastic bottle chug lid red	305 x 93 x 93	1	8	4932498637	4058546525064
② PACKOUT™ 1005 ml plastic bottle chug lid black	305 x 93 x 93	1	8	4932498640	4058546525095
③ PACKOUT™ 1420 ml plastic bottle chug lid red	337 x 99 x 99	1	6	4932498638	4058546525071
PACKOUT™ 1420 ml plastic bottle chug lid black	337 x 99 x 99	1	6	4932498641	4058546525101
④ PACKOUT™ plastic bottle chug lid	86 x 76 x 76	1	1	4932498642	4058546525118



Packout™ mounting puck

- Mount all PACKOUT™ bottles, mugs and tumblers on flat surfaces.
- Easy mounting with screws or adhesive tape.

Description	Dimensions (Outer) (H x W x D / mm)	Pack quantity	Min. order quantity	Article Number	EAN Code
Packout™ mounting puck	18 x 86 x 86	1	1	4932493469	4058546483401



PACKOUT™ shop storage power tool starter kit

- Includes PACKOUT™ XL mounting plate 4932480622, PACKOUT™ drill storage station 4932480712, M18™ battery holder 4932480709, M12™ battery holder 4932480708.

Description	Pack quantity	Min. order quantity	Article Number	EAN Code
PACKOUT™ shop storage power tool starter kit	4	1	4932493620	4058546484910



PACKOUT™ storage hooks

- High strength steel hooks for storing even heavy tools and items.
- Hook coating protects hooks and stored items.
- Easy and fast access to all tools.
- Most secure and easy mounting with click & lock mechanism.
- Fully customise your shop according to your needs.
- Part of PACKOUT™ Shop Storage.

Description	Dimensions (Outer) (H x W x D / mm)	Pack quantity	Min. order quantity	Article Number	EAN Code
① PACKOUT™ straight utility hook	203 x 89 x 229	1	5	4932480700	4058546409852
② PACKOUT™ curved utility hook	279 x 89 x 152	1	5	4932480701	4058546409869
③ PACKOUT™ large hook	203 x 152 x 229	1	3	4932480702	4058546409876
④ PACKOUT™ large S hook	38 x 89 x 178	1	5	4932480703	4058546409883
⑤ PACKOUT™ small straight utility hook	102 x 89 x 102	1	5	4932480704	4058546409890
⑥ PACKOUT™ small curved utility hook	178 x 89 x 76	1	5	4932480705	4058546409906
⑦ PACKOUT™ small hook row	100 x 232 x 77	1	6	4932493384	4058546482558
⑧ PACKOUT™ single straight hook	98 x 98 x 120	1	5	4932493383	4058546482541

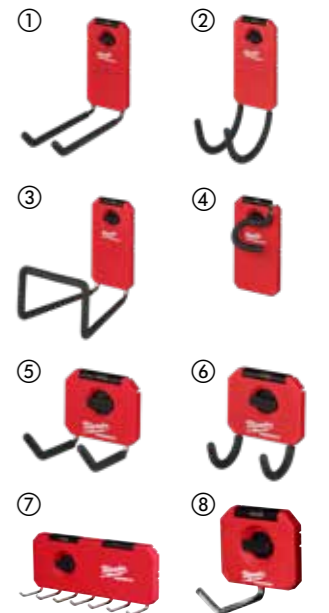

PACKOUT™ storage racks

- Easy and fast access to all tools and items.
- Most secure and easy mounting with click & lock mechanism.
- Fully customise your shop according to your needs.
- Part of PACKOUT™ Shop Storage.

Description	Dimensions (Outer) (H x W x D / mm)	Pack quantity	Min. order quantity	Article Number	EAN Code
① PACKOUT™ cup holder	127 x 102 x 178	1	4	4932480706	4058546409913
② PACKOUT™ paper towel holder	165 x 102 x 330	1	5	4932480707	4058546409920
③ PACKOUT™ pliers rack	89 x 241 x 127	1	6	4932480710	4058546409951
④ PACKOUT™ screwdriver rack	90 x 236 x 90	1	6	4932480711	4058546409968
⑤ PACKOUT™ small shelf	254 x 241 x 89	1	5	4932480713	4058546409982
⑥ PACKOUT™ belt clip rack	90 x 234 x 40	1	6	4932493377	4058546482480
⑦ PACKOUT™ magnetic rack	92 x 234 x 65	1	4	4932493378	4058546482497
⑧ PACKOUT™ wire basket	172 x 252 x 190	1	4	4932493379	4058546482503



PACKOUT™ battery holders

- Organise your batteries.
- Clip in batteries for secure storage.
- Easy and fast access to all batteries.
- Most secure and easy mounting with click & lock mechanism.
- Fully customise your shop according to your needs.
- Part of PACKOUT™ Shop Storage.

Description	Dimensions (Outer) (H x W x D / mm)	Pack quantity	Min. order quantity	Article Number	EAN Code
① PACKOUT™ M12™ battery holder	66 x 102 x 330	1	6	4932480708	4058546409937
② PACKOUT™ M18™ battery holder	102 x 102 x 330	1	4	4932480709	4058546409944



PACKOUT™ easy access storage

- Easy and fast access to all tools.
- Most secure and easy mounting with click & lock mechanism.
- Fully customise your shop according to your needs.
- Part of PACKOUT™ Shop Storage.

Description	Dimensions (Outer) (H x W x D / mm)	Pack quantity	Min. order quantity	Article Number	EAN Code
① PACKOUT™ drill storage station	254 x 241 x 356	1	2	4932480712	4058546409975
② PACKOUT™ long handled storage	178 x 241 x 356	1	3	4932480714	4058546409999
③ PACKOUT™ single long handles storage	347 x 97 x 127	1	6	4932493382	4058546482534



PACKOUT™ bins

- Stores screws, tapes and other small items.
- Nest bins come with removable dividers and interior trays for additional organisation.
- Hangs on PACKOUT™ Wall Mounting Plates.
- Nest Bins fit in PACKOUT™ Organizer (4932464082) & PACKOUT™ Compact Organizer (4932464083).
- Magnetic Bins fit in PACKOUT™ Slim Organiser (4932471064) & PACKOUT™ Compact Slim Organiser (4932471065).
- Magnetic Bins can be also attached to metal surfaces due to magnetic back.
- Constructed with impact resistant polymers.
- Part of PACKOUT™ Shop Storage.

Description	Dimensions (Outer) (H x W x D / mm)	Pack quantity	Min. order quantity	Article Number	EAN Code
① PACKOUT™ 10x10 cm nest bin	46 x 102 x 102	2	6	4932480698	4058546409838
② PACKOUT™ 10x20 cm nest bin	46 x 203 x 102	2	6	4932480699	4058546409845
③ PACKOUT™ magnetic bin 10x10 cm	10 x 10 x 45	1	6	4932493380	4058546482510
④ PACKOUT™ magnetic bin 10x20 cm	10 x 20 x 45	1	6	4932493381	4058546482527



Linesman's compact aerial tool apron

- Durable vinyl construction.
- Dedicated pockets for better organisation.
- Auger bit holder won't burn through.
- Puncture resistant knife pockets for knife storage.
- Dedicated flood light pocket.
- Magnets hold sockets in place.
- Durable nickle plated brass eyelets.
- D-rings for more storage.
- Weep holes let water out.



Description	Dimensions (Outer) (H x W x D / mm)	Pack quantity	Min. order quantity	Article Number	EAN Code
Linesman's compact aerial tool apron	600 x 457 x 100	1	1	4932498652	4058546525217

Linesman's aerial tool apron

- Durable vinyl construction.
- Dedicated pockets for better organisation.
- Auger bit holder won't burn through.
- Puncture resistant knife pockets for knife storage.
- Dedicated flood light pocket.
- Magnets hold sockets in place.
- Durable nickle plated brass eyelets.
- D-rings for more storage.
- Weep holes let water out.



Description	Dimensions (Outer) (H x W x D / mm)	Pack quantity	Min. order quantity	Article Number	EAN Code
Linesman's aerial tool apron	600 x 640 x 100	1	1	4932498653	4058546525224

Aerial oval bag

- 1680D ballistic material construction.
- 2 puncture resistant knife pockets.
- Impact resistant molded base.
- 14 pockets for ultimate organisation.
- Weep holes let water out.
- 2 durable nickle plated brass eyelets.
- 2 D-rings for more storage.
- Carrying strap for easy transportation.
- Storage ideal for power tools, accessories and hand tools.



Description	Dimensions (Outer) (H x W x D / mm)	Pack quantity	Min. order quantity	Article Number	EAN Code
Aerial oval bag	265 x 729 x 370	1	1	4932498654	4058546525231

Underground oval bag

- 1680D ballistic material construction.
- 2 puncture resistant knife pockets.
- 24 pockets for ultimate organisation.
- Weep holes let water out.
- 2 durable nickle plated brass eyelets.
- 2 D-rings for more storage.
- Carrying strap for easy transportation.
- Storage ideal for power tools, accessories and hand tools.



Description	Dimensions (Outer) (H x W x D / mm)	Pack quantity	Min. order quantity	Article Number	EAN Code
Underground oval bag	265 x 729 x 370	1	1	4932498655	4058546525248



Textile utility bucket

- Swiveling metal carabiner.
- Weight capacity 34 kg.
- Durable material for long lifetime.
- Weep holes let water out.
- Reinforced ring keeps bag open.



Description	Dimensions (Outer) (H x W x D / mm)	Pack quantity	Min. order quantity	Article Number	EAN Code
Textile utility bucket	370 x 300 x 300	1	1	4932498656	4058546525255



Textile utility bucket with pockets

- Swiveling metal carabiner.
- Weight capacity 34 kg.
- Durable material for long lifetime.
- Weep holes let water out.
- Reinforced ring keeps bag open.



Description	Dimensions (Outer) (H x W x D / mm)	Pack quantity	Min. order quantity	Article Number	EAN Code
Textile utility bucket with pockets	370 x 300 x 300	1	1	4932498657	4058546525262



Ultimate jobsite backpack

- Constructed with 1680D ballistic material and with rugged metal zippers to provide increased durability.
- Hard molded base allows backpack to stand up and reduces ingress of dirt and water.
- Adjustable chest strap and attachment strap for rolling bags.
- Padded and breathable load-bearing harness evenly distributes the weight for more comfort and jobsite performance.
- 48 total pockets including 2 hardshell pockets to protect electronics and equipment from impact.
- Backpack provides exceptional organisation.



Description	Dimensions (Outer) (H x W x D / mm)	Pack quantity	Min. order quantity	Article Number	EAN Code
Ultimate jobsite backpack	240 x 457 x 518	1	1	4932464833	4058546227784



Jobsite backpack

- Durable construction, made from 1680D ballistic nylon.
- Hard moulded base allows bag to stand-up and provides ultimate all-weather protection.
- Padded, breathable straps for ultimate comfort and jobsite performance.
- Large storage - 35 pockets in total.
- Fold down front pocket for easier access and storage of larger items. Side water bottle pocket.
- Vertical tool wall maximises storage space while allowing for bulk storage space.
- Laptop pocket allows protected storage for laptops/tablets and personal goods.
- Exterior daisy chains allow clip on storage.



Description	Dimensions (Outer) (H x W x D / mm)	Pack quantity	Min. order quantity	Article Number	EAN Code
Jobsite backpack	363 x 203 x 594	1	1	4932500309	4058546616113



Tradesman backpack

- Durable construction, made from 1680D ballistic nylon.
- Padded straps for more comfort and jobsite performance.
- Laptop pocket allows protected storage for laptops/tablets and personal goods.
- 18 organiser pockets allow variety of options.



Description	Dimensions (Outer) (H x W x D / mm)	Pack quantity	Min. order quantity	Article Number	EAN Code
Tradesman backpack	360 x 210 x 520	1	1	4932464252	4058546221973

Low profile backpack

- Constructed with 1680D ballistic material and with rugged metal zippers to provide increased durability.
- Reinforced base protects the backpack from being damaged by abusive jobsite conditions.
- Adjustable chest strap and attachment strap for rolling bags.
- Padded and breathable load-bearing harness evenly distributes the weight for more comfort and jobsite performance.
- 22 pockets including a padded electronic sleeve to provide ultimate organisation.



Description	Dimensions (Outer) (H x W x D / mm)	Pack quantity	Min. order quantity	Article Number	EAN Code
Low profile backpack	200 x 300 x 498	1	1	4932464834	4058546227791

Jobsite cooler

- Constructed with 1680D ballistic material and with rugged metal zippers to provide increased durability.
- Specifically designed to be durable enough to withstand tough jobsite conditions.
- Cooler utilises double insulation and a food-grade leak proof liner to keep ice cold for 24 hours without leaking.
- Tape measure clip with a bottle opener provides ultimate versatility.
- Padded shoulder strap with metal hardware for ultimate durability.
- Tech pocket and dry storage compartment for storing tablets and electronic devices.



Description	Dimensions (Outer) (H x W x D / mm)	Pack quantity	Min. order quantity	Article Number	EAN Code
Jobsite cooler	280 x 350 x 380	1	1	4932464835	4058546227807

Electricians pouch

- Robust construction, made from 1680D ballistic nylon.
- Double stitched with stronger riveted seams.
- Integrated handle allows easy transport and provides an easy mounting point on common jobsite materials.
- Solid base allows bag to stand-up, even when fully loaded.
- Integrated belt loops allow bag to be worn on a tool belt.
- Center mounted metal D-rings allow bag to hang evenly from shoulder strap.
- Metal tape measure clip securely stores tape for easy access.



Description	Pack quantity	Min. order quantity	Article Number	EAN Code
Electricians pouch	1	1	4932500308	4058546616106

Electricians belt

- Robust construction, made from 1680D ballistic nylon.
- Double stitched with stronger riveted seams.
- Integrated handles allow easy transport of the pouch and provides easy mounting point on common jobsite materials.
- Padded, breathable belt for ultimate comfort and jobsite performance.
- Metal suspender attachments allow suspenders to be added.
- Metal tape measure clip securely stores tape for easy access.



Description	Pack quantity	Min. order quantity	Article Number	EAN Code
Electricians belt	1	1	4932500307	4058546616090

Work belt

- Metal hardware and 1680D ballistic nylon provide a lifetime of service.
- Up to 152 mm (6") of padding and can accommodate waist sizes up to 143 mm (53").



Description	Pack quantity	Min. order quantity	Article Number	EAN Code
Work belt	1	1	4932500127	4058546572914

Contractor rig

- Robust construction, made from 1680D ballistic nylon.
- Double stitched with stronger riveted seams.
- Padded 4-point harness distributes weight for all day comfort.
- Padded, breathable belt for ultimate comfort and jobsite performance.
- Integrated handle allows easy transport of the pouch and provides easy mounting point on common jobsite materials.
- Metal suspender attachments allow suspenders to be added.



Description	Pack quantity	Min. order quantity	Article Number	EAN Code
Contractor rig	1	1	4932500306	4058546616083

HEAVY DUTY™ boxes

- Cases supplied with latches.

HD box size	Dimensions (Outer)(H x W x D / mm)	Pack quantity	Min. order quantity	Article Number	EAN Code
1	132 x 475 x 358	1	1	4932453385	4002395146376
2	475 x 358 x 192	1	1	4932383162	4002395349463
3	230 x 475 x 358	1	1	4932453386	4002395143634
HD box size 2 - with FUEL™ logo	180 x 475 x 362	1	1	4932498753	4058546526221
HD Box 1 universal - supplied with foam in the lid		1	1	4932459751	4058546029234
Spare latches		2	1	4932373252	4002395347247
PACKOUT™ adaptor HD box	117 x 500 x 386	1	1	4932464081	4058546220266



Padded rig

- Adjustable straps designed to fit all users.
- 1680D ballistic material construction.



Description	Pack quantity	Min. order quantity	Article Number	EAN Code
Padded rig	1	1	4932500128	4058546572921

TOOLGUARD™ STEEL STORAGE



**CUSTOMISE YOUR
TOOLGUARD™ STEEL
STORAGE DRAWERS WITH
OUR ONLINE FOAM INSERT
CONFIGURATOR**

TOOLGUARD™ 30" / 78 cm 7-drawer steel storage rolling cabinet

- 45 kg rated soft-close drawers.
- Bottom drawer rated at 90 kg.
- Anti-tilt protection allows only 1 drawer to be open at a time.
- Each drawer supplied with anti-slip mat inlay.
- Recessed ABS worktop with screwdriver holes and additional compartments.
- ABS corner bumpers prevent damages when moved around the garage.
- Magnetic power strip allows to charge batteries directly on the cabinet.
- Peg board with hooks and tool holders for an easy access to the most used tools.
- Additional side shelves for bottles and cans.
- Power tool organiser in the bottom drawer.
- 125 mm industrial casters (2x fixed, 2x swiveling with brakes).
- 800 kg total weight capacity.



Description	Dimensions (Outer) (H x W x D / mm)	Pack quantity	Min. order quantity	Article Number	EAN Code
TOOLGUARD™ 30" / 78 cm 7-drawer steel storage rolling cabinet	1064 x 810 x 524	1	1	4932478849	4058546361310
TOOLGUARD™ 30" / 78 cm 7-drawer steel storage rolling cabinet - grey RAL 7021	1064 x 810 x 524	1	1	4932500742	4058546620448

TOOLGUARD™ 40" / 102 cm steel work cart

- 45 kg rated soft-close drawers.
- 90 kg rated sliding bottom shelf.
- Built-in storage compartments.
- 2 removable storage cups, which can be flipped upside down to create a flush surface or completely removed for vertical long tool storage.
- V-grooves to hold material when cutting or measuring.
- Foldable rear shelf with 22 kg weight capacity.
- 2 moveable shelves for storing bottles, sprays and other equipment.
- Rubber corner bumpers prevent damages when moved around the garage.
- Magnetic power strip allows to charge batteries directly on the cart.
- 125 mm industrial casters (2x fixed, 2x swiveling with brakes).
- 315 kg total weight capacity.



Description	Dimensions (Outer) (H x W x D / mm)	Pack quantity	Min. order quantity	Article Number	EAN Code
TOOLGUARD™ 40" / 102 cm steel work cart	1016 x 561 x 991	1	1	4932478856	4058546361389

TOOLGUARD™ 30" / 78 cm 4-drawer steel storage top chest

- 45 kg rated soft-close drawers.
- Anti-tilt protection allows only 1 drawer to be open at a time.
- Each drawer supplied with anti-slip mat inlay.
- ABS corner bumpers prevent damages when moved around the garage.
- Additional side shelves for bottles and cans.



Description	Dimensions (Outer) (H x W x D / mm)	Pack quantity	Min. order quantity	Article Number	EAN Code
TOOLGUARD™ 30" / 78 cm 4-drawer steel storage top chest	810 x 524 x 498	1	1	4932478850	4058546361327

TOOLGUARD™ 46" / 117 cm high capacity 10-drawer steel storage rolling cabinet

- 45 kg rated soft-close drawers.
- Bottom drawers rated at 90 kg.
- Each drawer supplied with anti-slip mat inlay.
- Rubber corner bumpers prevent damages when moved around the garage.
- Magnetic power strip allows to charge batteries directly on the cabinet.
- Foldable side shelf for bottles and cans.
- Integrated bottle opener.
- Power tool organiser in the bottom drawer.
- 150 mm industrial casters (2x fixed, 2x swiveling with brakes).
- 1360 kg total weight capacity.



Description	Dimensions (Outer) (H x W x D / mm)	Pack quantity	Min. order quantity	Article Number	EAN Code
TOOLGUARD™ 46" / 117 cm high capacity 10-drawer steel storage rolling cabinet	1170 x 562 x 982	1	1	4932478852	4058546361341

TOOLGUARD™ 46" / 117 cm high capacity 6-drawer steel storage top chest

- 45 kg rated soft-close drawers.
- Each drawer supplied with anti-slip mat inlay.
- Work top drawer for writing or using a laptop.
- Independent locking safety drawer to securely store valuable items (phone, keys, documents).
- Rubber corner bumpers prevent damages when moved around the garage.
- Magnetic power strip allows to charge batteries directly on the chest.
- Peg board with hooks on the back wall for an easy access to the most used tools.



Description	Dimensions (Outer) (H x W x D / mm)	Pack quantity	Min. order quantity	Article Number	EAN Code
TOOLGUARD™ 46" / 117 cm high capacity 6-drawer steel storage top chest	1170 x 562 x 644	1	1	4932478854	4058546361365

TOOLGUARD™ 27" / 69cm 7-drawer steel rolling cabinet

- 35 kg rated drawers.
- Bottom drawer rated at 70 kg.
- Anti-tilt protection allows only 1 drawer to be open at a time.
- Each drawer supplied with anti-slip mat inlay.
- Recessed ABS worktop with screwdriver holes and additional compartments.
- Peg board on both sides for hooks and tool holders for an easy access to the most used tools.
- Removable side shelves for bottles and cans.
- Metal divider in the bottom drawer for extra organisation.
- 125 mm industrial casters with soft surface for smooth rolling (2x fixed, 2x swiveling with 1x brake).
- Ready for immediate use - cabinet comes with casters mounted.
- 625 kg total weight capacity.



Description	Dimensions (Outer) (H x W x D / mm)	Pack quantity	Min. order quantity	Article Number	EAN Code
TOOLGUARD™ 27" / 69cm 7-drawer steel rolling cabinet	971 x 741 x 520 (with handle)	1	1	4932498252	4058546521219
TOOLGUARD™ 27" / 69cm 7-drawer steel rolling cabinet - grey RAL 7021	971 x 741 x 520 (with handle)	1	1	4932500740	4058546620424

PVC Work Surface

- PVC Work Surface for the 46" / 117 cm High Capacity 10-Drawer Steel Storage Rolling Cabinet.
- Enables productive and safe work on top of the 46" Steel Storage Rolling Cabinet.
- Prevents items from rolling or falling from the surface.
- Easy installation with two adhesives strips (included in delivery).



Description	Pack quantity	Min. order quantity	Article Number	EAN Code
PVC Work Surface 46"	1	1	4932492547	4058546419141

Can holder

- Holds spray cans or bottles.
- Compatible with the TOOLGUARD™ 27"/69cm Steel Rolling Cabinet (4932498252).



Description	Pack quantity	Min. order quantity	Article Number	EAN Code
Can holder	1	1	4932498955	4058546528249
Can holder grey	1	1	4932501311	4058546640279

Paper towel holder

- Roll Holder for paper towels up to 30 cm width and 26 cm diameter.
- Compatible with TOOLGUARD™ pegboards of steel rolling cabinets 4932498252, 4932478849 and 4932478851.



Description	Pack quantity	Min. order quantity	Article Number	EAN Code
Paper towel holder	1	1	4932498956	4058546528256

Single steel hook

- Universal metal single hook.
- Compatible with TOOLGUARD™ pegboards.



Description	Pack quantity	Min. order quantity	Article Number	EAN Code
Single steel hook	12	1	4932498957	4058546528263

Double steel hook

- Universal metal double hook.
- Compatible with TOOLGUARD™ pegboards.



Description	Pack quantity	Min. order quantity	Article Number	EAN Code
Double steel hook	12	1	4932498958	4058546528270

Magnetic power centre

- Socket strip with 3x sockets for EU or UK plug and 2x USB-A sockets (UK version 3x USB-A).
- Magnetic holder that enables to place the power centre on any metal surface.
- Available colours: Red, Grey.



Description	Pack quantity	Min. order quantity	Article Number	EAN Code
Magnetic power centre	1	1	4932498959	4058546528287
Magnetic power centre grey	1	1	4932501310	4058546640262

246pcs filled 30" / 78 cm TOOLGUARD™ EU premium version

- 45 kg rated soft-close drawers & bottom drawer rated at 90 kg.
- Anti-tilt protection allows only one drawer to be open at a time.
- 125 mm industrial casters (2x fixed, 2x swiveling with brakes).
- 5 drawers filled with essential tools needed for automotive maintenance, neatly placed in foam inserts for best organization.
- M18FIW2F12 MID TORQUE IMPACT WRENCH: Power efficiency under load - outstanding torque of 339 Nm within an extremely compact design - total length of just 124 mm for access into tight spaces.
- 2x M18™ RESISTANT 5.0 AH BATTERY included: New housing material provides more protection against oils, solvents and greases.
- M12™ - M18™ FAST CHARGER: Recharges all M18™, M14™ and M12™ REDLITHIUM™ battery packs.
- Available colours: Red, Grey.



Description	Pack quantity	Min. order quantity	Article Number	EAN Code
246pc 30" / 78 cm red filled TOOLGUARD™ EU premium version	246	1	4932493817	4058546509774
246pc 30" / 78 cm grey filled TOOLGUARD™ EU premium version			4932500743	4058546620455

119 pc 1/4", 3/8", 1/2" Ratchet & socket foam set (4932498518), 27 pc MAXBITE Metric combination spanner foam set (4932493247), 4 pc Pliers foam set (4932493631), 15 pc MAXBITE Metric ratcheting combination spanner foam set (4932479828), 10 pc Double open end spanner foam set (4932493629), 23 pc Trilobe screwdriver foam set (4932479830), 3 pc Circlip pliers foam set (4932493632), 2 pc Engineer and dead blow hammer foam set (4932493253), 3 pc Cutting and measuring foam set (4932493252), 32 pc 1/2" Shockwave STD foam set 1 (4932493392), M18FIW2F12-0 COMPACT IMPACT WRENCH (4933498058), 2x M18™ RESISTANT 5.0 AH BATTERY (4932479265), M12™ - M18™ FAST CHARGER (4932451079), Safety glasses clear (4932478763), 3 pcs Reusable corded ear plugs (4932471904), 30 INCH STEEL ROLLING CABINET (4932478849)

206pcs filled 30" / 78 cm TOOLGUARD™ EU standard version

- 45 kg rated soft-close drawers & bottom drawer rated at 90 kg.
- Anti-tilt protection allows only one drawer to be open at a time.
- 125 mm industrial casters (2x fixed, 2x swiveling with brakes).
- 5 drawers filled with essential tools needed for automotive maintenance, neatly placed in foam inserts for best organization.
- Available colours: Red, Grey.



Description	Pack quantity	Min. order quantity	Article Number	EAN Code
206pc 30" / 78 cm red filled TOOLGUARD™ EU Standard version	206	1	4932498185	4058546520540
206pc 30" / 78 cm grey filled TOOLGUARD™ EU Standard version			4932500744	4058546620462

119 pc 1/4", 3/8", 1/2" Ratchet & socket foam set (4932498518), 27 pc MAXBITE Metric combination spanner foam set (4932493247), 4 pc Pliers foam set (4932493631), 15 pc MAXBITE Metric ratcheting combination spanner foam set (4932479828), 10 pc Double open end spanner foam set (4932493629), 23 pc Trilobe screwdriver foam set (4932479830), 3 pc Circlip pliers foam set (4932493632), 2 pc Engineer and dead blow hammer foam set (4932493253), 3 pc Cutting and measuring foam set (4932493252), 30 INCH STEEL ROLLING CABINET (4932478849)

131pcs filled 27" / 69 cm TOOLGUARD™ Universal tools

- 3 out of 7 drawers filled with essential tools, neatly placed in foam inserts for best organization.
- 35 kg rated drawers & bottom drawer rated at 70 kg.
- Anti-tilt protection allows only one drawer to be open at a time.
- 125 mm industrial casters (2x fixed, 2x swiveling, 1x brake).
- Ratchets with 90 tooth design with 4 °of arc swing for tight work spaces.
- Combination Spanners with MAX BITE™ open-end grip reduces rounding and stripping.
- Screwdrivers with comfortable Tri-Lobe handle optimized for maximum user comfort and high torque applications.
- Available colours: Red, Grey.



Description	Pack quantity	Min. order quantity	Article Number	EAN Code
131pc 27" / 69 cm red filled TOOLGUARD™ - Universal tools	131	1	4932499182	4058546563462
131pc 27" / 69 cm grey filled TOOLGUARD™ - Universal tools			4932500741	4058546624552

28pc 1/4" Ratchet and socket set foam insert (4932479824), 23pc 3/8" Ratchet and socket set foam insert (4932479825), 28pc 1/2" Ratchet and socket set foam insert (4932479826), MAX BITE™ Combination spanner set foam insert (4932479827), 6pc Tri-Lobe screwdriver TX set foam insert (4932492392), 7pc Tri-Lobe screwdriver SL & PH set foam insert (4932492394), 15pc general tooling foam set (4932493257)

337pcs filled 27" / 69 cm TOOLGUARD™ automotive set

- Durable storage solution with 35 kg rated drawers & bottom drawer rated at 70 kg, 125 mm industrial casters (2x fixed, 2x swiveling, 1x brake) and anti-tilt protection allows only one drawer to be open at a time.
- Hand tools and accessories selection with 337 most premium tools, neatly placed in foam inserts for best organization – Fully kitted. Ratchets with 90 tooth design with 4° of arc swing for tight spaces, combination spanners with MAX BITE™ open-end grip reduces rounding and stripping and screwdrivers with comfortable Tri-Lobe handle optimized for maximum user comfort and high torque applications.
- Premium foam which is easy to clean, water- and oil resistant and very light-weighted but still provides high durability.
- Available colours: Red, Grey.



Description	Pack quantity	Min. order quantity	Article Number	EAN Code
337 pc 27" / 69 cm red filled TOOLGUARD™ automotive set	337	1	4932500754	4058546620561
337 pc 27" / 69 cm grey filled TOOLGUARD™ automotive set			4932500746	4058546620486

4932500740 SRC27/7-2, 4932500755 38 pc Screwdriver and prybar set foam insert, 4932500756 153 pc 1/4" and 3/8" ratchet and socket and bit socket set foam insert, 4932500757 60 pc 1/2" ratchet and impact socket set foam insert, 4932500758 36 pc mixed spanner set foam insert, 4932500759 36 pc spanner, lights, cutting and measuring set foam insert, 4932500760 14 pc pliers and hammer set foam insert

337pcs filled 30" / 78 cm TOOLGUARD™ automotive set

- Durable storage solution with 45 kg rated drawers & bottom drawer rated at 90 kg, 125 mm industrial casters (2x fixed, 2x swiveling with brakes) and anti-tilt protection allows only one drawer to be open at a time.
- Hand tools and accessories selection with 337 most premium tools, neatly placed in foam inserts for best organization – Fully kitted. Ratchets with 90 tooth design with 4° of arc swing for tight spaces, combination spanners with MAX BITE™ open-end grip reduces rounding and stripping and screwdrivers with comfortable Tri-Lobe handle optimized for maximum user comfort and high torque applications.
- Premium foam which is easy to clean, water- and oil resistant and very light-weighted but still provides high durability.
- Available colours: Red, Grey.



Description	Pack quantity	Min. order quantity	Article Number	EAN Code
337 pc 30" / 78 cm red filled TOOLGUARD™ automotive set	337	1	4932500753	4058546620554
337 pc 30" / 78 cm grey filled TOOLGUARD™ automotive set			4932500745	4058546620479

4932500742 SRC30/7-2, 4932500755 38 pc Screwdriver and prybar set foam insert, 4932500756 153 pc 1/4" and 3/8" ratchet and socket and bit socket set foam insert, 4932500757 60 pc 1/2" ratchet and impact socket set foam insert, 4932500758 36 pc mixed spanner set foam insert, 4932500759 36 pc spanner, lights, cutting and measuring set foam insert, 4932500760 14 pc pliers and hammer set foam insert

Master foam insert set universal 170pc

- Ideal mix of innovative hand tools for maintenance and repair, organized in premium foam inserts.
- Ratchets with 90 tooth design with 4° of arc swing for tight work spaces.
- Combination Spanners with MAX BITE™ open-end grip reduces rounding and stripping.
- Screwdrivers with comfortable Tri-Lobe handle optimized for maximum user comfort and high torque applications.
- Premium foam for longer durability, laser cut sizes for easy and quick size identification and red background to identify quickly missing tools.



Description	Pack quantity	Min. order quantity	Article Number	EAN Code
Master foam insert set universal 170pc				
28pc 1/4" Ratchet and socket set foam insert (4932479824), 28pc 1/2" Ratchet and socket set foam insert (4932479826), MAX BITE™ Combination spanner set foam insert (4932479827), 23pc Trilobe screwdriver foam insert (4932479830), 8pc Folding torx key set (4932480979), Compact hex key 9pc set (4932492399), SHOCKWAVE™ IMPACT DUTY bit set 40 pc (4932492004), Metral drill HSSG ThW D338 Set 19pc (4932493869)	170	1	4932499473	4058546566371

Master foam insert set automotive 172pc

- Ideal mix of innovative hand tools for automotive maintenance and repair, organized in premium foam inserts.
- Ratchets with 90 tooth design with 4° of arc swing for tight work spaces.
- Combination Spanners with MAX BITE™ open-end grip reduces rounding and stripping.
- T-bar handle with 180° durable swiveling socket for best access in hard-to-reach angles.
- Screwdrivers with comfortable Tri-Lobe handle optimized for maximum user comfort and high torque applications.
- Premium foam for longer durability, laser cut sizes for easy and quick size identification and red background to identify quickly missing tools.



Description	Pack quantity	Min. order quantity	Article Number	EAN Code
Master foam insert set automotive 172pc				
28pc 1/4" Ratchet and socket set foam insert (4932479824), 28pc 1/2" Ratchet and socket set foam insert (4932479826), MAX BITE™ Combination spanner set foam insert (4932479827), 8pc T-bar handle set foam insert (4932499113), 23pc Trilobe screwdriver foam insert (4932479830), 3pc Pliers set foam insert (4932493256), 3PC Circlip Pliers Foam Insert Set (4932493632), 2pc Engineer and dead blow hammer set foam insert (4932493253), 1/2" SHOCKWAVE™ IMPACT DUTY automotive impact socket set (4932493370), SHOCKWAVE™ IMPACT DUTY bit set 40pc (4932492004), Metral drill HSSG ThW D338 Set 19pc (4932493869)	172	1	4932499474	4058546566388

Master foam insert set industrial 244pc

- Ideal mix of innovative hand tools for industrial maintenance and repair, organized in premium foam inserts.
- Ratchets with 90 tooth design in 1/4", 3/8" and 1/2" drive sizes, with 4° of arc swing for tight work spaces.
- Combination Spanners with MAX BITE™ open-end grip reduces rounding and stripping.
- Screwdrivers with comfortable Tri-Lobe handle optimized for maximum user comfort and high torque applications.
- Premium foam for longer durability, laser cut sizes for easy and quick size identification and red background to identify quickly missing tools.



Description	Pack quantity	Min. order quantity	Article Number	EAN Code
Master foam insert set industrial 244pc				
28pc 1/4", 3/8" and 1/2" Ratchet and socket set foam insert (4932498518), MAX BITE™ Combination spanner set foam insert (4932479827), 10pc Double open end spanner foam insert set (4932493629), 23pc Trilobe screwdriver foam insert (4932479830), General tooling foam set 15pc (4932493257), 3PC Circlip Pliers Foam Insert Set (4932493632), SHOCKWAVE™ IMPACT DUTY bit set 40pc (4932492004), Metral drill HSSG ThW D338 Set 19pc (4932493869)	244	1	4932499475	4058546566395

3/3 MAX BITE™ Combination Spanner Set Foam Inserts

- MAX BITE™ open-end grip reduces rounding and stripping.
- Rounded I-Beam handle for comfortable handling grip.
- 15° offset box for better accessibility.
- Chrome alloy steel, chrome plated.

Description	Dimensions (Outer) (H x W x D / mm)	Pack quantity	Min. order quantity	Article Number	EAN Code
① 27 pc MAX BITE™ metric combination spanner foam set	45 x 536 x 417	27	1	4932493247	4058546481186
6mm, 7mm, 8mm, 9mm, 10mm, 11mm, 12mm, 13mm, 14mm, 15mm, 16mm, 17mm, 18mm, 19mm, 20mm, 21mm, 22mm, 23mm, 24mm, 25mm, 26mm, 27mm, 28mm, 30mm, 32mm, 36mm					
Empty 27 pc MAX BITE™ Combination Spanner Foam Set	45 x 536 x 417	1	1	4932493676	4058546508364
② 22pc MAX BITE™ ratcheting metric combination spanner set	45 x 536 x 417	22	1	4932493248	4058546481193
6mm, 7mm, 8mm, 9mm, 10mm, 11mm, 12mm, 13mm, 14mm, 15mm, 16mm, 17mm, 18mm, 19mm, 20mm, 21mm, 22mm, 24mm, 25mm, 27mm, 30mm, 32mm					
Empty 22 pc MAXBITE™ Ratcheting Combination Spanner Foam Set	45 x 536 x 417	1	1	4932493677	4058546508371



MAX BITE™ Flex Head Ratcheting Spanner Set Foam Insert

- 180° pivoting head for greater access to tight spaces.
- MAX BITE™ open-end grip reduces rounding and stripping.
- 144 ratcheting teeth positions giving 2.5° arc swing allowing access in tighter spaces.
- Durable double stacked pawls for longer ratchet life.
- Rounded I-Beam handle for comfortable handling grip.

Description	Dimensions (Outer) (H x W x D / mm)	Pack quantity	Min. order quantity	Article Number	EAN Code
MAX BITE™ Flex Head Ratcheting Spanner Set Foam Insert	45 x 178.5 x 417	15	1	4932479829	4058546376239
8, 9, 10, 11, 12, 13, 14, 15, 16, 17, 18, 19, 20, 21, 22 mm					
Empty 15 pc MAX BITE™ Flex Head Spanner Set Foam Insert	45 x 178.5 x 417	1	1	4932493667	4058546513610



MAX BITE™ combination spanner set foam insert

- MAX BITE™ open-end grip reduces rounding and stripping.
- Rounded I-Beam handle for comfortable handling grip.
- 15° offset box for better accessibility.
- Chrome alloy steel, chrome plated.

Description	Dimensions (Outer) (H x W x D / mm)	Pack quantity	Min. order quantity	Article Number	EAN Code
MAX BITE™ Combination Spanner Set Foam Insert	45 x 178.5 x 417	15	1	4932479827	4058546376215
8, 9, 10, 11, 12, 13, 14, 15, 16, 17, 18, 19, 20, 21, 22 mm					
Empty 15 pc MAX BITE™ Combination Spanner Set Foam Insert	45 x 178.5 x 417	1	1	4932493665	4058546485368



MAX BITE™ Ratcheting Combination Spanner Set Foam Insert

- 144 Ratcheting teeth positions giving 2.5° arc swing allowing access in tighter spaces.
- Durable double stacked pawls for long-lasting ratchet life.
- MAX BITE™ open-end grip reduces rounding and stripping.
- Rounded I-Beam handle for comfortable handling grip.

Description	Dimensions (Outer) (H x W x D / mm)	Pack quantity	Min. order quantity	Article Number	EAN Code
MAX BITE™ Ratcheting Combination Spanner Set Foam Insert	45 x 178.5 x 417	15	1	4932479828	4058546376222
8, 9, 10, 11, 12, 13, 14, 15, 16, 17, 18, 19, 20, 21, 22 mm					
Empty 15 pc MAX BITE™ Ratcheting Combination Spanner Set Foam Insert	45 x 178.5 x 417	1	1	4932493666	4058546513603



Double Open End Spanner Foam Insert Set

- Slim head dimensions for access in tight areas.
- Rounded I-beam handle for comfortably applying torque.
- Ink-filled size labels for easy and quick size identification.
- Chrome finish for corrosion and rust resistance.
- Sets come in a durable foam.

Description	Dimensions (Outer) (H x W x D / mm)	Pack quantity	Min. order quantity	Article Number	EAN Code
① 10pc Double Open End Spanner Foam Insert Set	45 x 178.5 x 417	10	1	4932493629	4058546485009
6x7, 8x9, 10x11, 12x13, 14x15, 16x17, 18x19, 20x22, 21x23, 24x27mm					
② 4pc Double Open End Spanner Foam Insert Set	45 x 178.5 x 417	4	1	4932493630	4058546485016
24x26, 25x28, 27x29, 30x32mm					

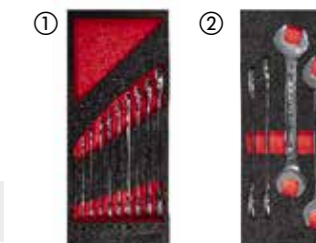

Flare Nut Spanner Foam Insert Set

- Optimized head geometry for secure grip on fasteners to reduce rounding of nuts.
- I-beam handle for more comfort while applying high torque.
- Ink-filled size labels for easy and quick size identification.
- 15° angled heads for better access.
- Set is neatly stored in a durable foam.

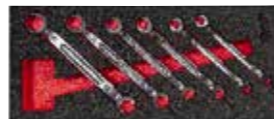

Description	Dimensions (Outer) (H x W x D / mm)	Pack quantity	Min. order quantity	Article Number	EAN Code
6pc Flare Nut Spanner Foam Insert Set 8x10, 10x11, 12x14, 13x14, 17x19, 19x22mm	45 x 178.5 x 417	6	1	4932493628	4058546484996

Double ring offset spanner set foam insert 9pc

- 75° offset handle for better access in tight spaces.
- Rounded I-beam handle for comfortably applying torque.
- Ink-filled size labels for easy and quick size identification.
- Chrome finish for corrosion and rust resistance.
- Premium foam for longer durability, laser cut sizes for easy and quick size identification and red background to identify quickly missing tools.



Description	Dimensions (Outer) (H x W x D / mm)	Pack quantity	Min. order quantity	Article Number	EAN Code
Double ring offset spanner set foam insert 9pc	45 x 178.5 x 417	9	1	4932499086	4058546529550
Replacement double ring offset spanner set foam insert	45 x 178.5 x 417	1	1	4932499087	4058546529567

Adjustable Wrench Set Foam Insert

- Precision adjustment screw with accurate threads and tight tolerances. The jaws won't back off during use
- Chrome plating for best-in-class rust protection and increased durability
- Ergonomic rounded handle design for a comfortable fit in the hand and less pressure points on the palm
- Slim head design for reaching into tight spaces
- Parallel jaws won't slip or damage finish surfaces
- Permanent lasered inch and mm markings for accurate adjustment
- Lanyard hole



Description	Dimensions (Outer) (H x W x D / mm)	Pack quantity	Min. order quantity	Article Number	EAN Code
3 pc Adjustable Wrench Set Foam Insert	45 x 178.5 x 417	3	1	4932492397	4058546417642
150mm, 200mm, 250mm					
Empty 3 pc Adjustable Wrench set Foam Insert	45 x 178.5 x 417	1	1	4932493674	4058546508340



1/4", 3/8" & 1/2" Ratchet and Socket Set Foam Insert

- 90 tooth design with 4° of arc swing for tight work spaces.
- FOUR FLAT™ sides on socket deter rolling.
- All metal design for maximum durability.
- Premium foam for longer durability, laser cut sizes for easy and quick size identification and red background to identify quickly missing tools.



Description	Dimensions (Outer) (H x W x D / mm)	Pack quantity	Min. order quantity	Article Number	EAN Code
1/4", 3/8", 1/2" Ratchet and Socket Foam Insert Set	45 x 536 x 417	119	1	4932498518	4058546523879
Empty 1/4", 3/8", 1/2" Ratchet and Socket Bare Foam Insert Replacement Foam	45 x 536 x 417	1	1	4932498740	4058546526092

1/4" Ratchet and Socket Set Foam Insert

- 90 tooth design with 4° of arc swing for tight work spaces.
- FOUR FLAT™ sides on socket deter rolling.
- All metal design for maximum durability.



Description	Dimensions (Outer) (H x W x D / mm)	Pack quantity	Min. order quantity	Article Number	EAN Code
1/4" Ratchet and Socket Set Foam Insert	45 x 178.5 x 417	28	1	4932479824	4058546376185
Standard sockets: 5 mm, 5.5 mm, 6 mm, 7 mm, 8 mm, 9 mm, 10 mm, 11 mm, 12 mm, 13 mm, 14 mm, 15 mm / Deep well sockets: 5 mm, 5.5 mm, 6 mm, 7 mm, 8 mm, 9 mm, 10 mm, 11 mm, 12 mm, 13 mm, 14 mm, 15 mm / 76 mm extension, 152 mm extension, universal joint					
Empty 28 pc 1/4" Ratchet and Socket Set Foam Insert	45 x 178.5 x 417	1	1	4932493662	4058546485337



1/4" Ratchet and bit socket set foam insert 76pc

- 90 tooth design with 4° of arc swing for tight work spaces.
- FOUR FLAT™ sides on socket deter rolling.
- All metal design for maximum durability.
- Premium foam for longer durability, laser cut sizes for easy and quick size identification and red background to identify quickly missing tools.

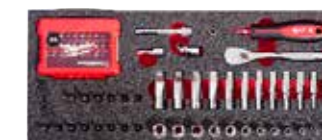

Description	Dimensions (Outer) (H x W x D / mm)	Pack quantity	Min. order quantity	Article Number	EAN Code
1/4" Ratchet and bit socket set foam insert 76pc					
Ratchet / Standard sockets: : 4mm, 4.5mm, 5mm, 5.5mm, 6mm, 7mm, 8mm, 9mm, 10mm, 11mm, 12mm, 13mm / Deep well sockets: 4mm, 4.5mm, 5mm, 5.5mm, 6mm, 7mm, 8mm, 9mm, 10mm, 11mm, 12mm, 13mm / Torx bit sockets: T8, T10, T15, T20, T25, T27, T30, T40 / Hex bit sockets: 2mm, 2.5mm, 3mm, 4mm, 5mm, 6mm / Drive bit holder / Universal joint adapter / Drive spinner handle / 38mm extension / 76 mm extension / 32pc SHOCKWAVE™ impact duty set	45 x 178.5 x 417	76	1	4932499293	4058546564575
1/4" Replacement ratchet and bit socket set foam insert	45 x 178.5 x 417	1	1	4932499294	4058546564582

3/8" Ratchet and Socket Set Foam Insert

- 90 tooth design with 4 ° of arc swing for tight work spaces.
- FOUR FLAT™ sides on socket deter rolling.
- All metal design for maximum durability.



Description	Dimensions (Outer) (H x W x D / mm)	Pack quantity	Min. order quantity	Article Number	EAN Code
3/8" Ratchet and Socket Set Foam Insert	45 x 178.5 x 417	32	1	4932479825	4058546376192
Standard sockets: 6 mm, 7 mm, 8 mm, 9 mm, 10 mm, 11 mm, 12 mm, 13 mm, 14 mm, 15 mm, 16 mm, 17 mm, 18 mm, 19 mm / Deep well sockets: 6 mm, 7 mm, 8 mm, 9 mm, 10 mm, 11 mm, 12 mm, 13 mm, 14 mm, 15 mm, 16 mm, 17 mm, 18 mm, 19 mm / 76 mm extension, 152 mm extension / Universal joint					
Empty 32 pc 3/8" Ratchet and Socket Set Foam Insert	45 x 178.5 x 417	1	1	4932493663	4058546485344

1/2" Ratchet and Socket Set Foam Insert

- 90 tooth design with 4 ° of arc swing for tight work spaces.
- FOUR FLAT™ sides on socket deter rolling.
- All metal design for maximum durability.



Description	Dimensions (Outer) (H x W x D / mm)	Pack quantity	Min. order quantity	Article Number	EAN Code
1/2" Ratchet and Socket Set Foam Insert	45 x 178.5 x 417	28	1	4932479826	4058546376208
Standard sockets: 10 mm, 11 mm, 12 mm, 13 mm, 14 mm, 15 mm, 16 mm, 17 mm, 18 mm, 19 mm, 20 mm, 21 mm, 22 mm, 23 mm, 24 mm / Deep well sockets: 10 mm, 11 mm, 12 mm, 13 mm, 14 mm, 15 mm, 16 mm, 17 mm, 18 mm, 19 mm / 76 mm extension, 127 mm extension					
Empty 28 pc 1/2" Ratchet and Socket Set Foam Insert	45 x 178.5 x 417	1	1	4932493664	4058546485351

T-bar handle set foam inserts

- 180° Durable swiveling socket for best access hard-to-reach angles.
- Sliding handle bar to optimal adjust to different positions for more leverage or narrow spaces.
- Shallow sockets to allow fastening of nuts with longer bolts.
- Premium foam for longer durability, laser cut sizes for easy and quick size identification and red background to identify quickly missing tools.

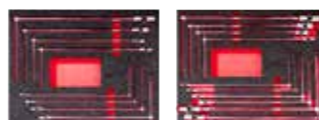

Description	Dimensions (Outer) (H x W x D / mm)	Pack quantity	Min. order quantity	Article Number	EAN Code
T-bar handle set foam insert 8pc					
7mm, 8mm, 10mm, 12mm, 13mm, 14mm, 17mm, 19mm	45 x 536 x 417	8	1	4932499113	4058546529826
Replacement t-bar handle set foam insert 8pc	45 x 536 x 417	1	1	4932499114	4058546529833
T-bar handle set foam insert 10pc					
7mm, 8mm, 10mm, 12mm, 13mm, 14mm, 15mm, 16mm, 17mm, 18mm	45 x 536 x 417	10	1	4932499295	4058546564599
Replacement t-bar handle set foam insert 10pc	45 x 536 x 417	1	1	4932499296	4058546564605

TORQUE LOCK™ Locking Pliers Set Foam Insert

- TORQUE LOCK™: Faster set up and easy release when clamping flat and round material. Extra force can be applied to the TORQUE LOCK™ screw for better and more secure grip. Can also be used for hanging / storage purposes.
- Hardened jaws: Better grip force on jobsite material.
- Rust protection: Chrome plated tool increases life by reducing corrosion.
- Lever release design: Traditional release lever for jobsite convenience.
- MAXBITE™ pliers have special jaw geometry for maximum grip.

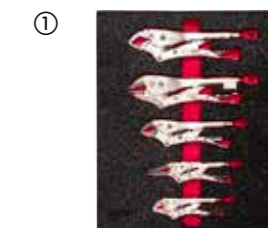

Description	Dimensions (Outer) (H x W x D / mm)	Pack quantity	Min. order quantity	Article Number	EAN Code
① 5PC Locking Plier Foam Insert Set	45 x 357 x 417	5	1	4932493634	4058546485054
Curved 127 mm (4932472263), Flat long nose 150 mm (4932471731), MAXBITE 170 mm (4932471730), Flat 250 mm (4932471726), MAXBITE 250 mm (4932471729)					
Empty 11 pc Grip Pliers Set Foam Insert	45 x 536 x 417	1	1	4932493680	4058546508401
② 11pc TORQUE LOCK™ Locking pliers set foam insert	45 x 536 x 417	11	1	4932493251	4058546481223
TORQUE LOCK™ locking pliers - Curved 127mm(4932472263); TORQUE LOCK™ locking pliers - Curved 170mm(4932471732), TORQUE LOCK™ locking pliers - Curved 250mm(4932471725), TORQUE LOCK™ locking C clamps - Regular pointed pads, 280mm(4932471728), TORQUE LOCK™ locking pliers - Flat long nose, 100mm(4932472262), TORQUE LOCK™ locking pliers - Flat long nose, 150mm(4932471731), TORQUE LOCK™ locking pliers - Flat long nose, 230mm(4932471733), TORQUE LOCK™ locking pliers - MAXBITE, 170mm(4932471730), TORQUE LOCK™ locking pliers - MAXBITE, 250mm(4932471729), TORQUE LOCK™ locking C clamps - Swivel pads, 280mm(4932471727), TORQUE LOCK™ locking C clamps - Swivel pads, 480mm(4932472261)					



Pliers Set Foam Insert

- Optimum leverage for easy and effortless work.
- Cutting edges induction hardened for cutting hard and soft wires.
- Corrosion protection for longer tool lifetime.
- Lanyard hole for easy attachment to the Milwaukee safety range to allow use at heights.

Description	Dimensions (Outer) (H x W x D / mm)	Pack quantity	Min. order quantity	Article Number	EAN Code
① 2pc Water pump pliers and TORQUE LOCK™ locking pliers set foam insert	45 x 178.5 x 417	2	1	4932493255	4058546481261
TORQUE LOCK™ locking pliers - Curved 250mm(4932471725), Adjustable Water pump pliermm(4932492459)					
Empty 2 pc Water pump & locking pliers Foam Set	45 x 178.5 x 417	1	1	4932493684	4058546508449
② 3pc Pliers set foam insert	45 x 178.5 x 417	3	1	4932493256	4058546481278
Combination Plier 180mm (4932492462), Diagonal cutting plier 160mm (4932492463), Long nose plier 205mm (4932492465)					
Empty 3 pc Pliers Set Foam Insert	45 x 178.5 x 417	1	1	4932493685	4058546508456
③ 4PC Pliers Foam Insert Set	45 x 178.5 x 417	4	1	4932493631	4058546485023
Combination pliers 180mm (4932492462), Diagonal cutter 160mm (4932492463), Long nose pliers 205 (straight) (4932492465), Waterpump pliers adjustable 240mm (4932492459)					

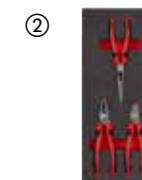

VDE Pliers Set Foam Insert

- VDE (DIN EN/IEC 60900) certified tools. Tested to 10,000 volts and guaranteed to 1,000 volts. Tested against cold to -40°.
- Steel blades are fully forged, hardened and tempered for best durability. Grey titanium surface finish is non reflective and ensures maximum corrosion resistance.
- Induction hardened cutting edges to cut even the hardest of materials.
- Precision machined joint for maximum power transmission with optimum leverage for easy and effortless work.
- Ergonomic grip with softgrip for comfortable handling and good grip.

Description	Dimensions (Outer) (H x W x D / mm)	Pack quantity	Min. order quantity	Article Number	EAN Code
① 4pc VDE Pliers set foam insert 160mm VDE Diagonal cutter, 205mm VDE long nose plier, 180mm VDE combination plier, 160mm VDE Wire stripping plier	45 x 178.5 x 417	4	1	4932493250	4058546481216
Empty 4 pc Insulated Pliers Set Foam Insert	45 x 178.5 x 417	1	1	4932493679	4058546508395
② 4PC VDE Pliers Set 2 Foam Insert 160mm VDE Diagonal cutter, 205mm VDE long nose plier, 160mm VDE cable cutter, 160mm VDE Wire stripping plier	45 x 178.5 x 417	4	1	4932493460	4058546483319
Empty 4 pc VDE Pliers Set 2 Foam Insert	45 x 178.5 x 417	1	1	4932493675	4058546508357



Circlip Pliers Foam Insert Set

- Easier and quicker internal-external conversion with anti-slip grooved dial.
- All-metal convertible dial for resistance against wear and prevents reduction in joint integrity.
- Slip-resistant grips with double-dipped handles.
- Stored in a premium foam.

Description	Dimensions (Outer) (H x W x D / mm)	Pack quantity	Min. order quantity	Article Number	EAN Code
① 3PC Circlip Pliers Foam Insert Set Medium Circlip Plier - Straight - 1.2mm tip (4932492490), Large Circlip Plier - Straight - 1.8mm tip (4932492493), Large Circlip Plier - 90° - 1.8mm tip (4932492495)	45 x 178.5 x 417	3	1	4932493632	4058546485030
② 6PC Circlip Pliers Foam Insert Set Small Circlip Plier - Straight - 0.9mm tip (4932492487), Small Circlip Plier - 45° - 0.9mm tip (4932492488), Medium Circlip Plier - Straight - 1.2mm tip (4932492490), Large Circlip Plier - Straight - 1.8mm tip (4932492493), Large Circlip Plier - 45° - 1.8mm tip (4932492494), Large Circlip Plier - 90° - 1.8mm tip (4932492495)	45 x 357 x 417	6	1	4932493633	4058546485047



General Tooling Set Foam Insert

- Hex Key Set: Twist and lock case for easy access to keys. Ball end for 30° access to any hex nut
- Pliers: Optimum leverage for easy and effortless work. Cutting edges induction hardened for cutting hard and soft wires
- Engineer Hammer: Reinforced head connection for added durability. Hickory handle providing low vibration
- Hacksaw: Tough metal frame, supports higher tension (25,000 PSI / 250 lbs)
- Magnetic Tape Measure: Strong magnet at start of the tape allows easy hooking onto flat surfaces and round pipe. Compact and ergonomic design



Description	Dimensions (Outer) (H x W x D / mm)	Pack quantity	Min. order quantity	Article Number	EAN Code
15pc General tooling foam set	45 x 536 x 417	15	1	4932493257	4058546481285
Hex Key 9 Pc Set (4932478621), Diagonal cutting plier 160mm (4932492463), Combination Plier 165mm (4932492461), Adjustable Water pump plier 250mm (4932492459), Hickory Engineers Hammer 500g (4932478668), Hacksaw (48220050), Magnetic Tape Measure 5m - 16ft (4932464602)					
Empty 15 pc General Tooling Foam Set	45 x 536 x 417	1	1	4932493686	4058546508463

Hammer set foam insert

- Precision balanced design for optimized control
- Durable grip handle with an anti-slip design
- Reduced vibration and minimized rebound



Description	Dimensions (Outer) (H x W x D / mm)	Pack quantity	Min. order quantity	Article Number	EAN Code
① 2pc Engineer and dead blow hammer set foam insert Fiberglass Engineers Hammer 500g (4932478663), 790 g Dead Blow Hammer (4932492350)	45 x 178.5 x 417	2	1	4932493253	4058546481247
Empty 2 pc Engineer & Dead blow hammer Foam set	45 x 178.5 x 417	1	1	4932493682	4058546508425
② 2pc Ball peen and dead blow hammer set foam insert 450 g Ball Peen Hammer (4932492346), 790 g Dead Blow Hammer (4932492350)	45 x 178.5 x 417	2	1	4932493254	4058546481254
Empty 2 pc Ball Peen & Dead blow hammer Foam set	45 x 178.5 x 417	1	1	4932493683	4058546508432



Screwdriver and prybar set foam insert

NEW

- Comfortable Tri-Lobe handle optimized for maximum user comfort and high torque applications.
- Pry bars with I-beam design and all-metal core for added durability.
- In-handle bit storage for quick and easy bit access with the 14in1 TX Multi-bit screwdriver.



Description	Pack quantity	Min. order quantity	Article Number	EAN Code
38 pc Screwdriver and prybar set foam insert	38	1	4932500755	4058546620578
Replacement foam screwdriver and prybar set foam insert	1	1	4932500761	4058546620639

1/4" and 3/8" Ratchet and socket and bit socket set foam insert

NEW

- FOUR FLAT™ sides on socket deter rolling.
- 90 tooth design ratchet with 4 °of arc swing for tight work spaces.
- Single forged piece bit socket design adds durability in high torque applications.
- Wobble functionality of wobble extension provides additional access in tight spaces and can also be used as a standard extension when fully inserted.



Description	Pack quantity	Min. order quantity	Article Number	EAN Code
153 pc 1/4" and 3/8" Ratchet and socket and bit socket set foam insert	153	1	4932500756	4058546620585
Replacement foam for 1/4" and 3/8" Ratchet and Socket and Bit Socket Set Foam Insert	1	1	4932500762	4058546620646

1/2" Ratchet and impact socket set foam insert

NEW

- FOUR FLAT™ sides on socket deter rolling.
- 90 tooth design ratchet with 4 °of arc swing for tight work spaces.
- Single forged piece bit socket design adds durability in high torque applications.



Description	Pack quantity	Min. order quantity	Article Number	EAN Code
60 pc 1/2" Ratchet and impact socket set foam insert	60	1	4932500757	4058546620592
Replacement foam for 60 pc 1/2" ratchet and impact socket set foam insert	1	1	4932500763	4058546620653

Mixed spanner set foam insert

NEW

- MAX BITE™ open-end grip reduces rounding and stripping.
- Rounded I-Beam handle for comfortable handling grip.
- Slim head dimensions of double open end spanners for access in tight areas.
- Ink-filled labels for clear visibility.
- Double ring offset spanners with 75° offset for better access in tight spaces.



Description	Pack quantity	Min. order quantity	Article Number	EAN Code
36 pc Mixed spanner set foam insert	36	1	4932500758	4058546620608
Replacement foam for 36 pc mixed spanner set foam insert	1	1	4932500764	4058546620660

Spanner, lights, cutting and measuring set foam insert

NEW

- MAX BITE™ open-end grip reduces rounding and stripping.
- Rounded I-Beam handle for comfortable handling grip.
- 144 Ratcheting teeth positions giving 2.5° arc swing allowing access in tighter spaces.
- Ink-filled labels for clear visibility.
- 144 Ratcheting teeth positions giving 2.5° arc swing allowing access in tighter spaces.
- TRUEVIEW™ high definition lighting with up to 400 lumens



Description	Pack quantity	Min. order quantity	Article Number	EAN Code
36pc Spanner, lights, cutting and measuring set foam insert	36	1	4932500759	4058546620615
Replacement foam for 36 pc spanner, lights, cutting and measuring set foam insert	1	1	4932500765	4058546620677

Pliers and hammer set foam insert

NEW

- Over moulded handle design for increased grip and reduced vibration while using the fiberglass engineer hammer.
- Optimum leverage for easy and effortless work with the MILWAUKEE® pliers.
- Easier and quicker internal-external conversion with anti-slip grooved and all metal dial for the circlip pliers.



Description	Pack quantity	Min. order quantity	Article Number	EAN Code
14pc Pliers and hammer set foam insert	14	1	4932500760	4058546620622
Replacement foam for 14pc pliers and hammer set foam insert	1	1	4932500766	4058546620684

Cutting and measuring set foam insert

- Compact Hacksaw: Tool free blade change for changing blades up to 10x faster & accepts 12" blades
- Snap Knife: Metal lock for maximum durability and longer lifetime
- Magnetic Tape Measure: Strong magnet at start of the tape allows easy hooking onto flat surfaces and round pipe. Compact and ergonomic design



Description	Dimensions (Outer) (H x W x D / mm)	Pack quantity	Min. order quantity	Article Number	EAN Code
3pc Cutting and measuring set foam insert	45 x 178.5 x 417	3	1	4932493252	4058546481230
Magnetic Tape Measure 5m - 16ft (4932464602), Snap knife 18mm (48221961), Compact Hacksaw (48220012)					
Empty 3 pc Cutting and Measuring Foam Insert	45 x 178.5 x 417	1	1	4932493681	4058546508418



Tri-lobe Screwdriver Foam Inserts

- Comfortable Tri-Lobe handle optimized for maximum user comfort and high torque applications
- Hardened magnetic tips for maximum durability and fastener retention
- Wrench ready shank allows extra leverage to be applied
- Anti-roll, 3 sided collar on the handle

Description	Dimensions (Outer) (H x W x D / mm)	Pack quantity	Min. order quantity	Article Number	EAN Code
① 7 pc Tri-Lobe Screwdriver TX Set 1 Foam Insert T7x65, T8x65, T9x75, T10x75, T15x75, T20x100, T25x100	45 x 178.5 x 417	7	1	4932492391	4058546417581
Empty 7 pc Screwdriver TX Set 1 Foam Insert	45 x 178.5 x 417	1	1	4932493669	4058546508296
② 6 pc Tri-Lobe Screwdriver TX Set 2 Foam Insert T10x75, T15x75, T20x100, T25x100, T30x125, T40x125	45 x 178.5 x 417	6	1	4932492392	4058546417598
Empty 6 pc Screwdriver TX Set 2 Foam Insert	45 x 178.5 x 417	1	1	4932493670	4058546508302
③ 5 pc Tri-Lobe Screwdriver PH Set Foam Insert PH0x75, PH1x100, PH2x125, PH3x150, Stubby PH2x45	45 x 178.5 x 417	5	1	4932492393	4058546417604
Empty 5 pc Screwdriver PH Set Foam Insert	45 x 178.5 x 417	1	1	4932493671	4058546508319
④ 7 pc Tri-Lobe Screwdriver SL Set Foam Insert SL 0.5x3x75, SL 0.6 x 3.5 x 100, SL 0.8x4x100, SL 1.0x5.5x125, SL 1.2x6.5x125, SL 1.6x8x175, Stubby SL 1.2x6.5x45	45 x 178.5 x 417	7	1	4932492395	4058546417628
Empty 7 pc Screwdriver SL Set Foam Insert	45 x 178.5 x 417	1	1	4932493673	4058546508333
⑤ 7 pc Tri-Lobe Screwdriver SL & PH Set Foam Insert SL 0.5x3x75, SL 0.8x4x100, SL 1.0x5.5x125, SL 1.2x6.5x125, PH0x75, PH1x100, PH2x125	45 x 178.5 x 417	7	1	4932492394	4058546417611
Empty 7 pc Screwdriver SL & PH Set Foam Insert	45 x 178.5 x 417	1	1	4932493672	4058546508326
⑥ Tri-lobe Screwdriver Foam Insert SL 2.5 / SL 3 / SL 4 / SL 5.5 / SL 6 / SL 6.5 / SL 8, PH 0 / PH 1 / PH 2 / PH 2 / PH 3, PZ 0 / PZ 1 / PZ 2 / PZ 2 / PZ 3, T 10 / T 15 / T 20 / T 25 / T 30 / T 40	45 x 536 x 417	23	1	4932479830	4058546376246
Empty 23 pc Tri-lobe Screwdriver Foam Insert	45 x 536 x 417	1	1	4932493668	4058546508289

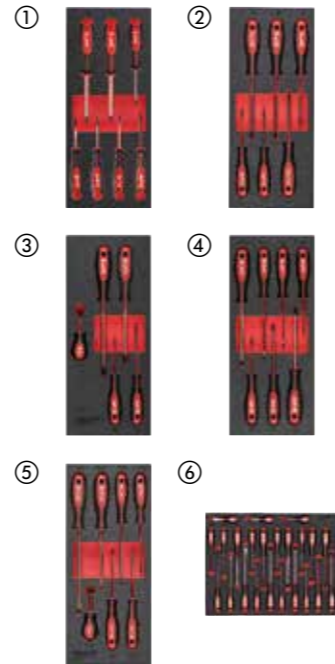

VDE Tri-lobe Screwdriver Set Foam Insert

- VDE tested to 10000 V and guaranteed to 1000 V
- Slim shank diameter for access to low lying screw applications
- Comfortable Tri-Lobe handle optimized for maximum user comfort and high torque applications
- Permanent visible ID markings allows for quick tool identification

Description	Dimensions (Outer) (H x W x D / mm)	Pack quantity	Min. order quantity	Article Number	EAN Code
8pc VDE Tri-Lobe screwdriver set foam insert PH0x60, PH1x80, PH2x100, 0.4x2.5x75, 0.6x3.5x100, 0.8x4x100, 1.0x5.5x125, 1.2x6.5x150	45 x 178.5 x 417	8	1	4932493249	4058546481209
Empty 8 pc Insulated Screwdriver set Foam Insert	45 x 178.5 x 417	1	1	4932493678	4058546508388



1/4" SHOCKWAVE™ IMPACT DUTY Foam Inserts

Description	Pack quantity	Min. order quantity	Article Number	EAN Code
1/4" Sockets deep foam set (17pc) SHOCKWAVE™ IMPACT DUTY 1/4" deep sockets: 4/4, 5/5, 5.5/6/7/8/9/10/11/12/13mm, magnetic bit holder 152 mm, magnetic bit holder 305mm, screwdriving bit set 32 pcs, adaptor 1/4" Hex --> 1/4" square, adaptor 1/4" square --> 1/4" Hex, Foam 417x177mm	17	1	4932493386	4058546482572
Replacement foam for 1/4" deep sockets. Size 417x177mm	1	1	4932493385	4058546482565



3/8" SHOCKWAVE™ IMPACT DUTY Foam Inserts

Description	Pack quantity	Min. order quantity	Article Number	EAN Code
3/8" sockets STD foam set (23pc) SHOCKWAVE™ IMPACT DUTY 3/8" STD sockets: 6/7/8/9/10/11/12/13/14/15/16/17/18/19/20/21/22mm, extension - 150mm, extension - 250mm, adaptor 3/8" square --> 1/4" square, adaptor 3/8" square --> 1/2" square, 3/8" swivel, adaptor 3/8" square --> 1/4" Hex, Foam 417x177mm	23	1	4932493388	4058546482596
3/8" Sockets deep foam set (23pc) SHOCKWAVE™ IMPACT DUTY 3/8" deep sockets: 6/7/8/9/10/11/12/13/14/15/16/17/18/19/20/21/22mm, extension - 150mm, extension - 250mm, adaptor 3/8" square --> 1/4" square, adaptor 3/8" square --> 1/2" square, swivel 3/8", adaptor 3/8" square --> 1/4" Hex, Foam 417x177mm	23	1	4932493390	4058546482619
Replacement foam for 3/8" STD sockets. Size 417x177mm	1	1	4932493387	4058546482589
Replacement foam for 3/8" deep sockets. Size 417x177mm	1	1	4932493389	4058546482602



1/2" SHOCKWAVE™ IMPACT DUTY Foam Inserts

Description	Pack quantity	Min. order quantity	Article Number	EAN Code
1/2" Sockets STD foam set (32pc) SHOCKWAVE™ IMPACT DUTY 1/2" STD socket: 8/9/10/11/12/13/14/15/16/17/18/19/20/21/22/23/24/25/26/27/28/29/30/32mm, Automotive Set 1/2": 17/19/21mm, extension - 150mm, extension - 250mm, adaptor 1/2" square --> 3/8" square, adaptor 1/2" square --> 3/4" square, 1/2" swivel, Foam with plastic base 417x536mm	32	1	4932493392	4058546482633
1/2" Sockets deep foam set (34pc) SHOCKWAVE™ IMPACT DUTY 1/2" deep Sockets: 8/9/10/11/12/13/14/15/16/17/18/19/20/21/22/23/24/25/26/27/28/29/30/32/33/36mm, Automotive Set 1/2": 17/19/21mm, extension - 150mm, extension - 250mm, adaptor 1/2" square --> 3/8" square, adapter 1/2" square --> 3/4" square, 1/2" Swivel, Foam with plastic base 417x536mm	34	1	4932493394	4058546482657
Replacement foam with plastic base for 1/2" STD sockets. Size 417x536mm	1	1	4932493391	4058546482626
Replacement foam with plastic base for 1/2" deep sockets. Size 417x536mm	1	1	4932493393	4058546482640





Nothing but **HEAVY DUTY.**TM

Techtronic Industries Middle East & Africa FZE

Showroom, S3A1SR07, JAFZA South

P.O. Box: 61254

Email: meainfo@tti-emea.com

www.ae.milwaukeetool.eu

www.za.milwaukeetool.eu

Distributed by: