



**EVOTECH**®  
P E R F O R M A N C E

**Installation Instructions**

## YAMAHA MT-09 2013 PILLION FOOTREST REMOVAL KIT

Product Reference - 11284

### Kit Contents

- A** 1 x RH Blanking Plate
- B** 1 x LH Blanking Plate
- C** 4 x M8 x 16 Black Socket Button Head Screws

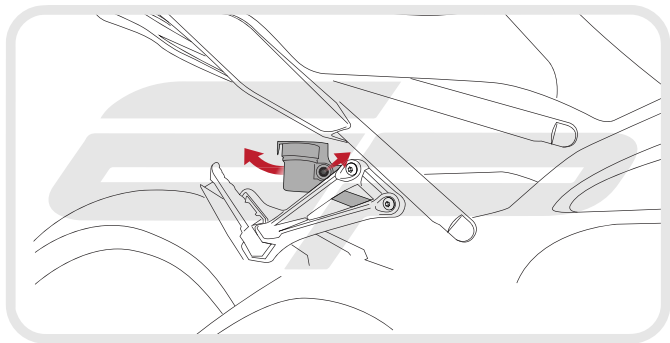

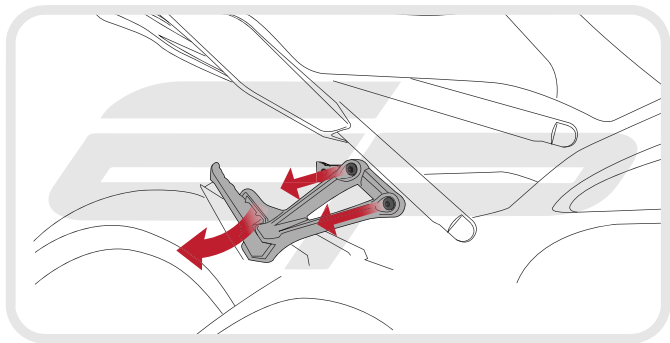

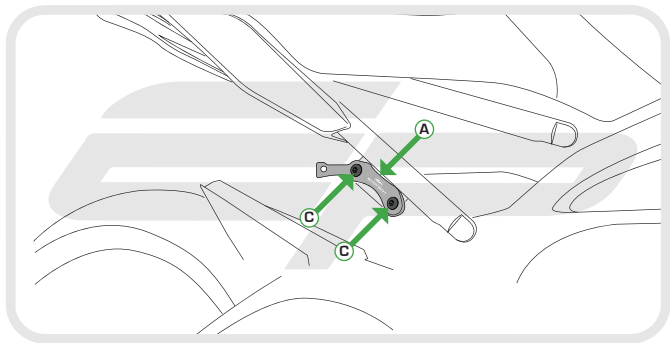

**EVOTECH**<sup>®</sup>  
P E R F O R M A N C E

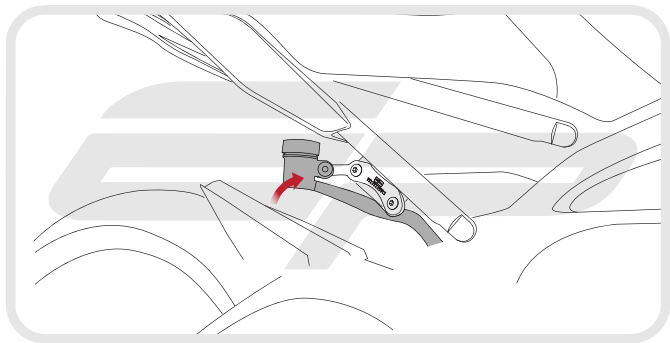

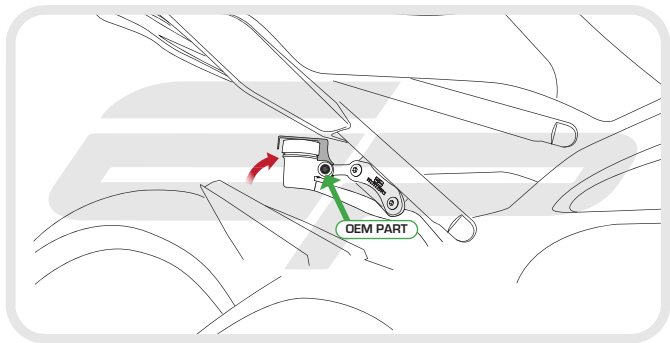

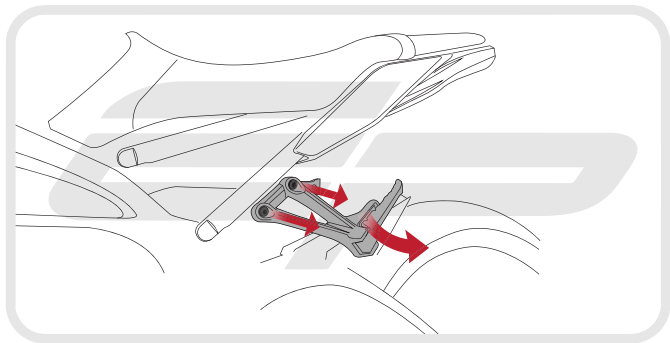

**EVOTECH**<sup>®</sup>  
P E R F O R M A N C E



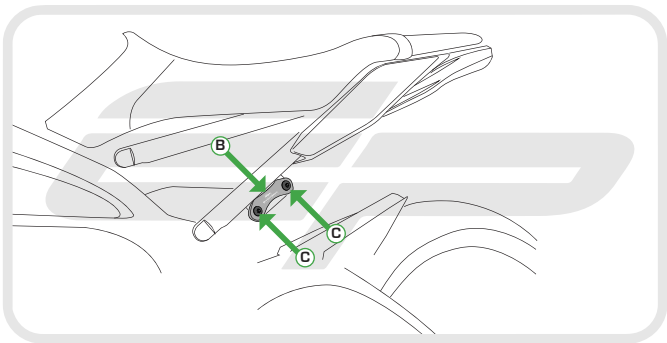



**EVOTECH**®  
P E R F O R M A N C E

[www.evotech-performance.com](http://www.evotech-performance.com)