



**EVOTECH**®  
P E R F O R M A N C E

**Installation Instructions**

## HONDA CBR1000 FIREBLADE 2010 ONWARDS TAIL TIDY

Product Reference - 7757

### Kit Contents

- |                                    |  |
|------------------------------------|--|
| <b>A</b> 1 x Main Tail Tidy        | <b>H</b> 2 x Long Mounting Arms        |
| <b>B</b> 1 x Reflector and Bracket | <b>I</b> 2 x Plastic Screws            |
| <b>C</b> 1 x Rubber Grommet        | <b>J</b> 2 x Plastic Nuts              |
| <b>D</b> 1 x LED Light Unit        | <b>K</b> 2 x Pair Bullet Connectors    |
| <b>E</b> 1 x M6 Flange Nut         | <b>L</b> 3 x Mounting Arm Caps         |
| <b>F</b> 1 x Short Mounting Arm    | <b>M</b> 3 x M4 - 8 Countersunk Screws |
| <b>G</b> 1 x Sealing Plate         | <b>N</b> 6 x Cable Ties                |

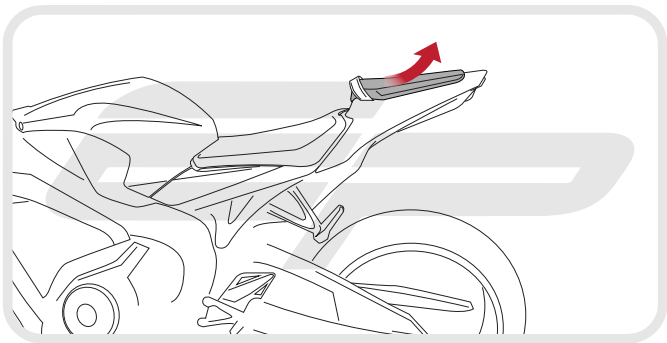

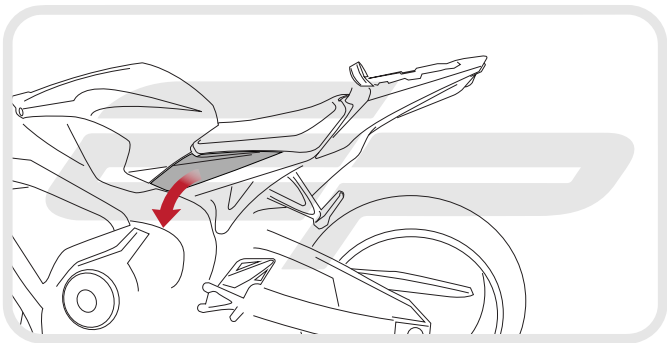

**EVOTECH**<sup>®</sup>  
P E R F O R M A N C E

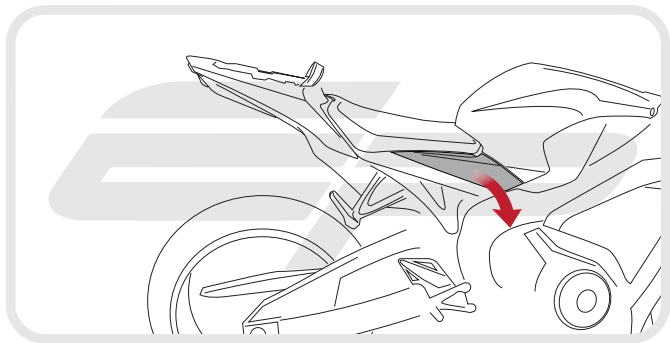

**EVOTECH**<sup>®</sup>  
P E R F O R M A N C E

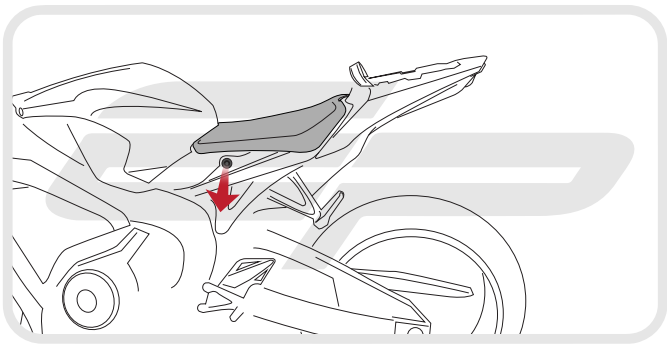

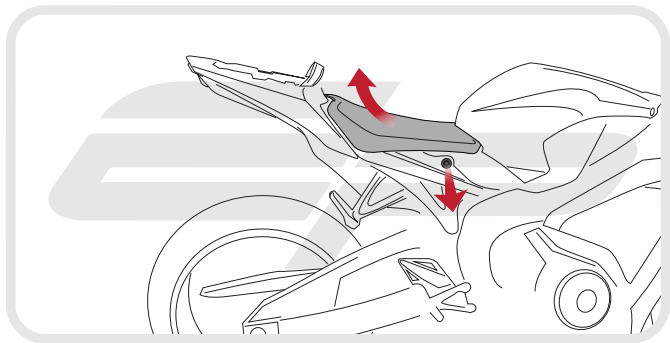



Caution

CAREFULLY DISCONNECT  
BATTERY TERMINALS  
ENSURING NEUTRAL IS  
REMOVED FIRST







Caution

WIRING LOOM IS TUCKED  
UNDERNEATH FUSEBOX

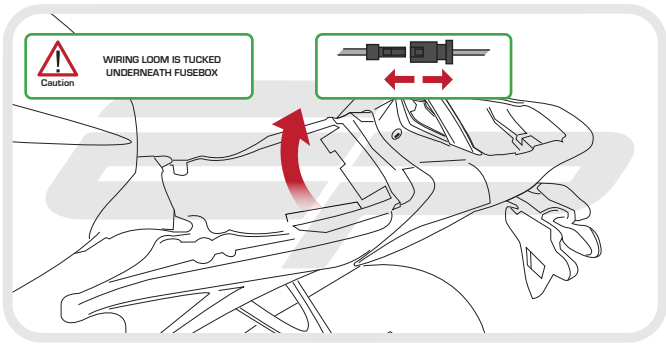

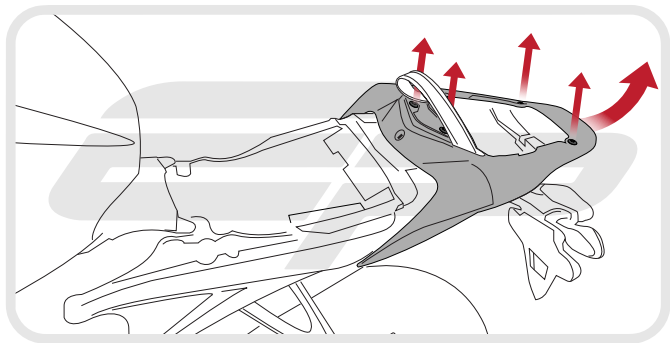

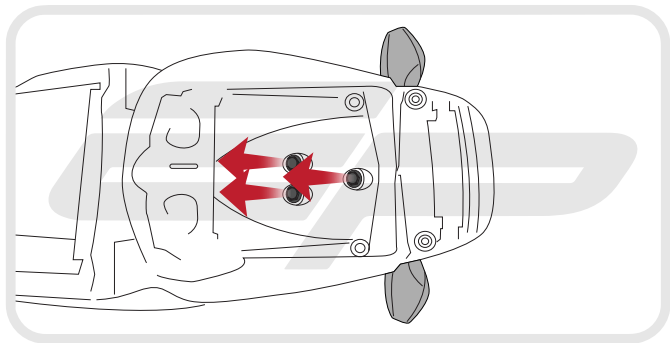

**EVOTECH**<sup>®</sup>  
P E R F O R M A N C E

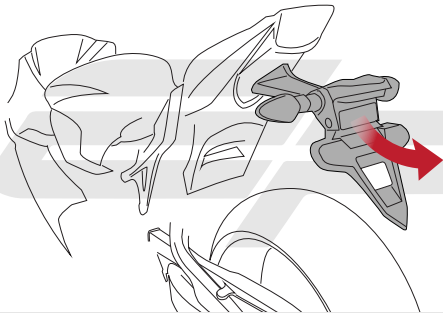

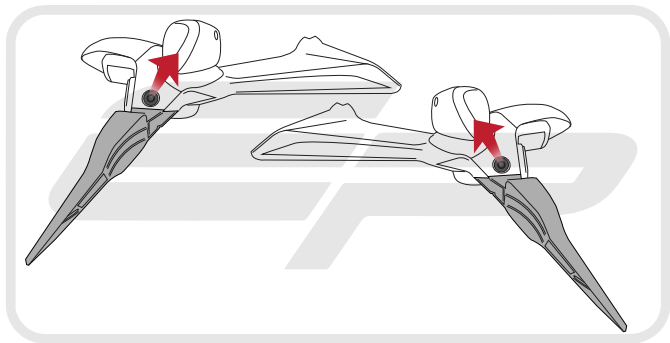

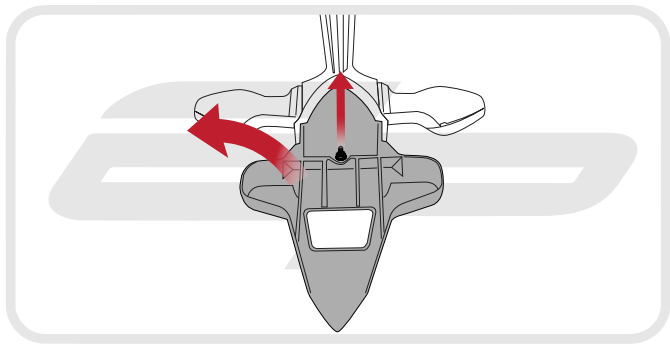

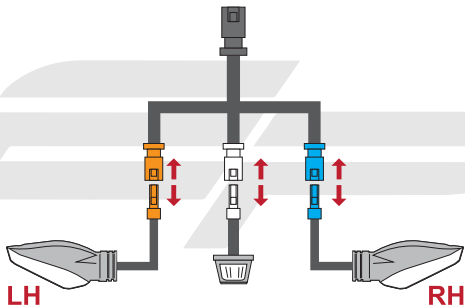

**EVOTECH**<sup>®</sup>  
P E R F O R M A N C E



REMOVE RETAINING PLATE AND RUBBER SEAL FROM ORIGINAL FENDER UNIT

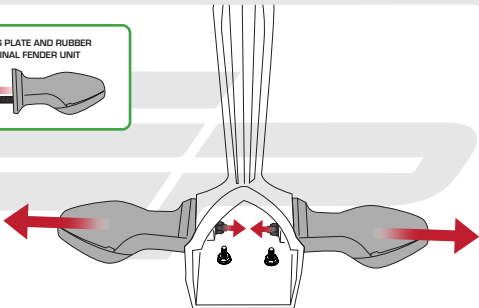





REFIT RETAINING PLATE AND RUBBER  
SEAL TO TAIL TIDY

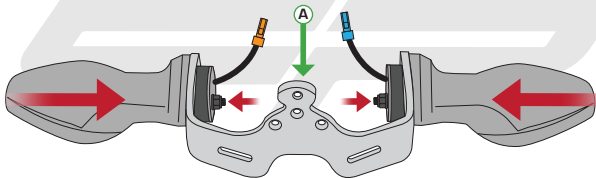

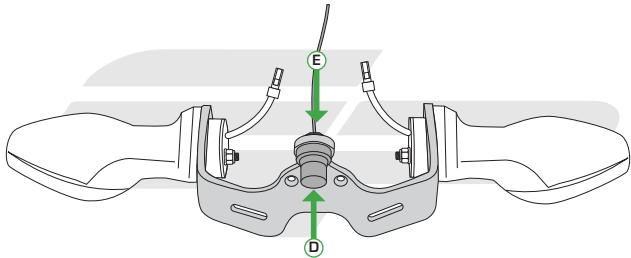

**EVOTECH**<sup>®</sup>  
P E R F O R M A N C E

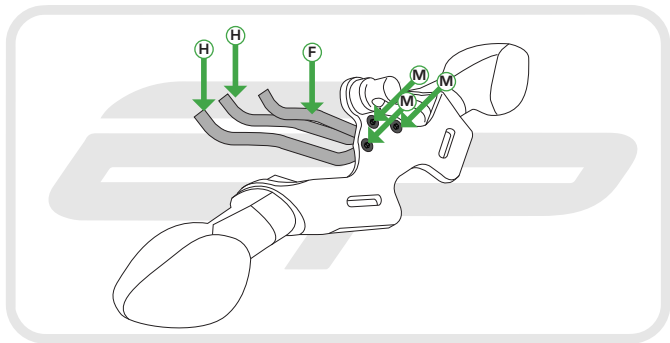

**EVOTECH**<sup>®</sup>  
P E R F O R M A N C E

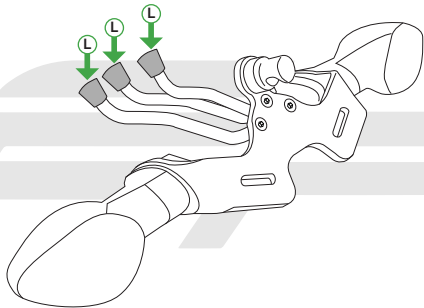

**EVOTECH**<sup>®</sup>  
P E R F O R M A N C E

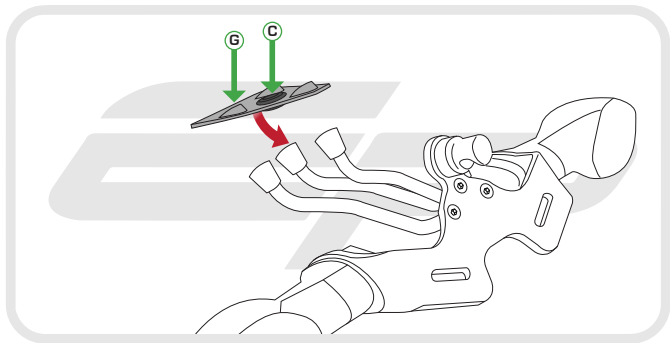

**EVOTECH**<sup>®</sup>  
P E R F O R M A N C E

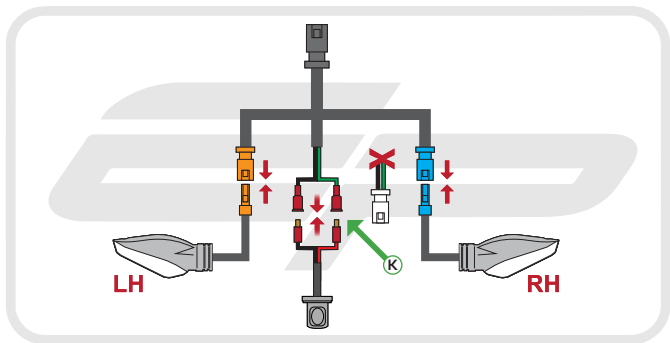

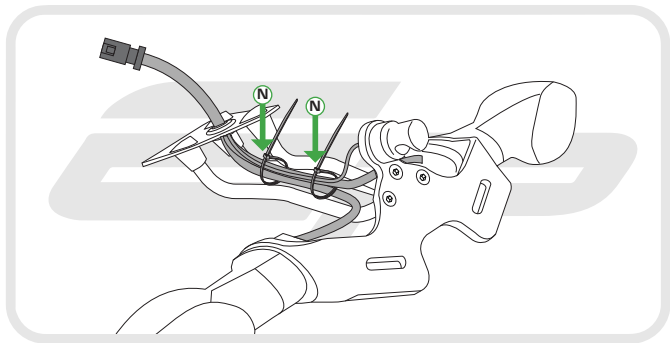

**EVOTECH**<sup>®</sup>  
P E R F O R M A N C E





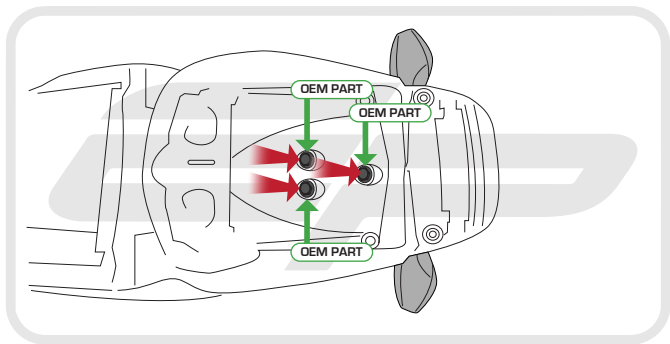



Reverse Stage

8 - 1



**EVOTECH**®  
P E R F O R M A N C E

[www.evotech-performance.com](http://www.evotech-performance.com)